

ТИПОВЫЕ КОНСТРУКЦИИ, ИЗДЕЛИЯ И УЗЛЫ ЗДАНИЙ И СООРУЖЕНИЙ

СЕРИЯ 1.020.1-4

КОНСТРУКЦИИ РАМНОГО КАРКАСА МЕЖВИДОВОГО ПРИМЕНЕНИЯ
ДЛЯ МНОГОЭТАЖНЫХ ОБЩЕСТВЕННЫХ ЗДАНИЙ, ПРОИЗВОДСТВЕННЫХ
И ВСПОМОГАТЕЛЬНЫХ ЗДАНИЙ ПРОМЫШЛЕННЫХ ПРЕДПРИЯТИЙ

выпуск 0-9

УКАЗАНИЯ ПО ПОДБОРУ ЭЛЕМЕНТОВ КАРКАСА
(Вариант армирования изделий сталью классов Ат-IVС и Врп-I).

часть 2

СТР 112-239

КНИГА 2
СТР.(176-239)

ОКОНЧАНИЕ

24166-02

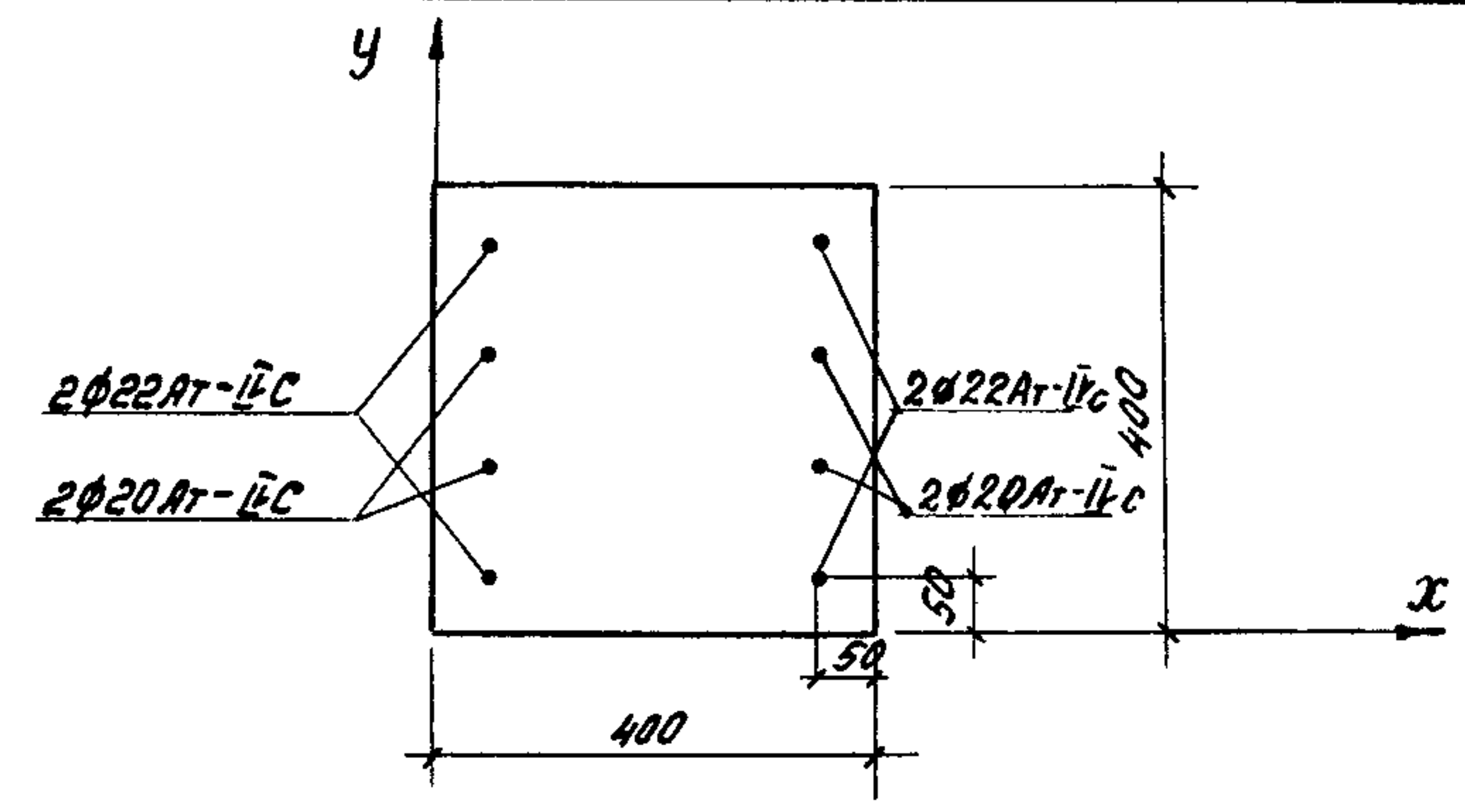
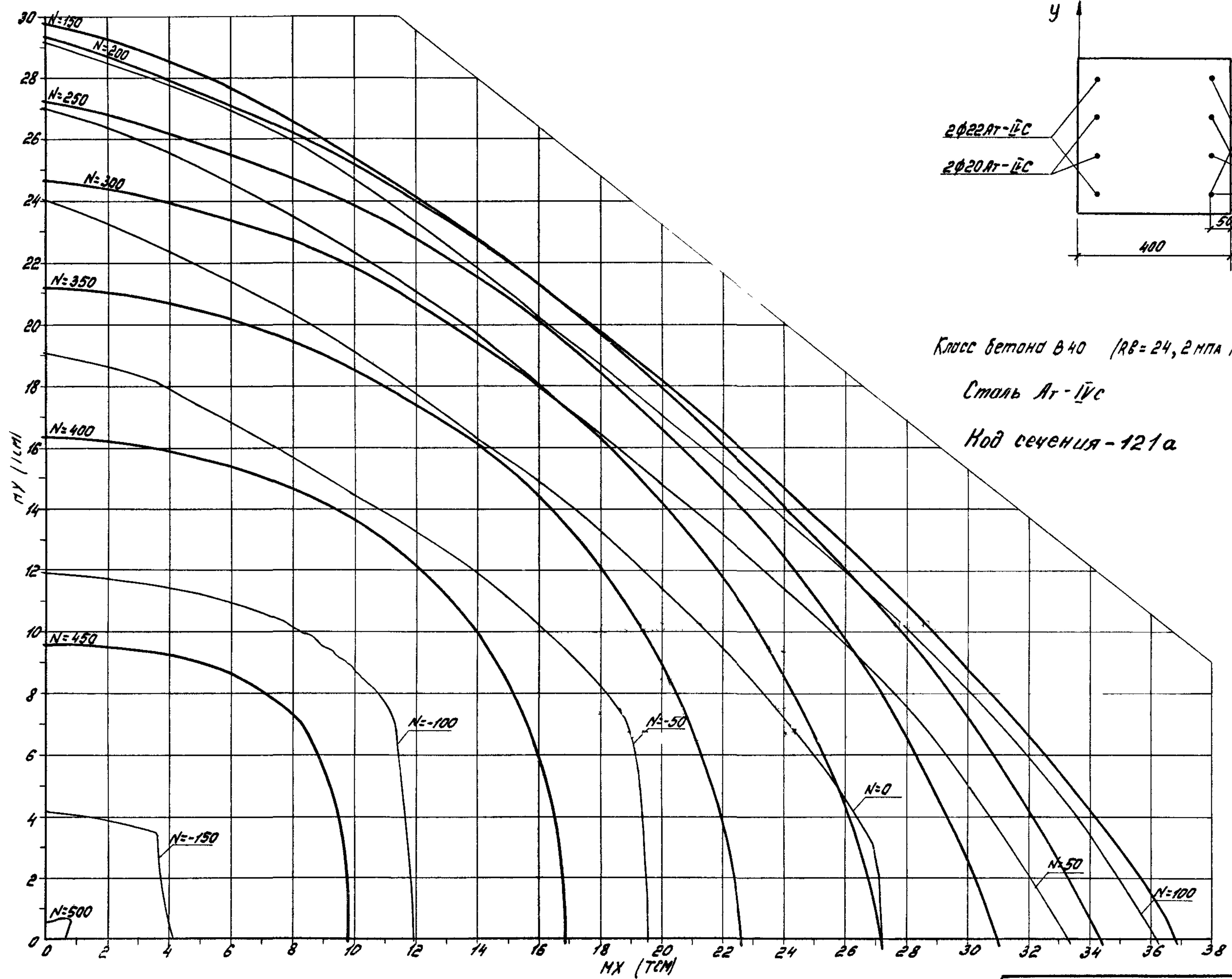

Класс бетона В40 ($R_b = 24,2 \text{ МПа}$ при учёте $\gamma_{b2} = 1,10$)
 Сталь Ar-IVc
 Код сечения - 121a

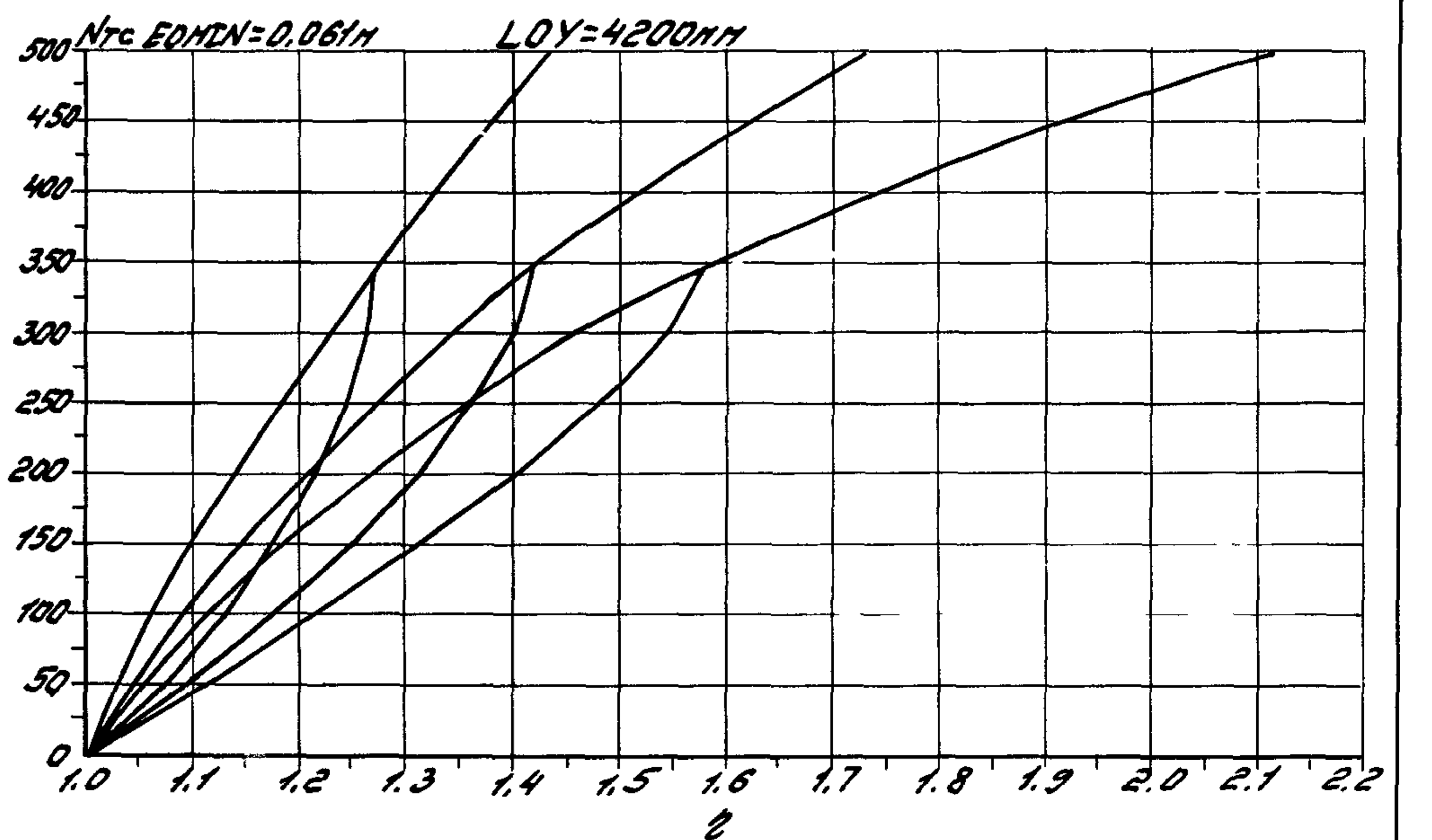
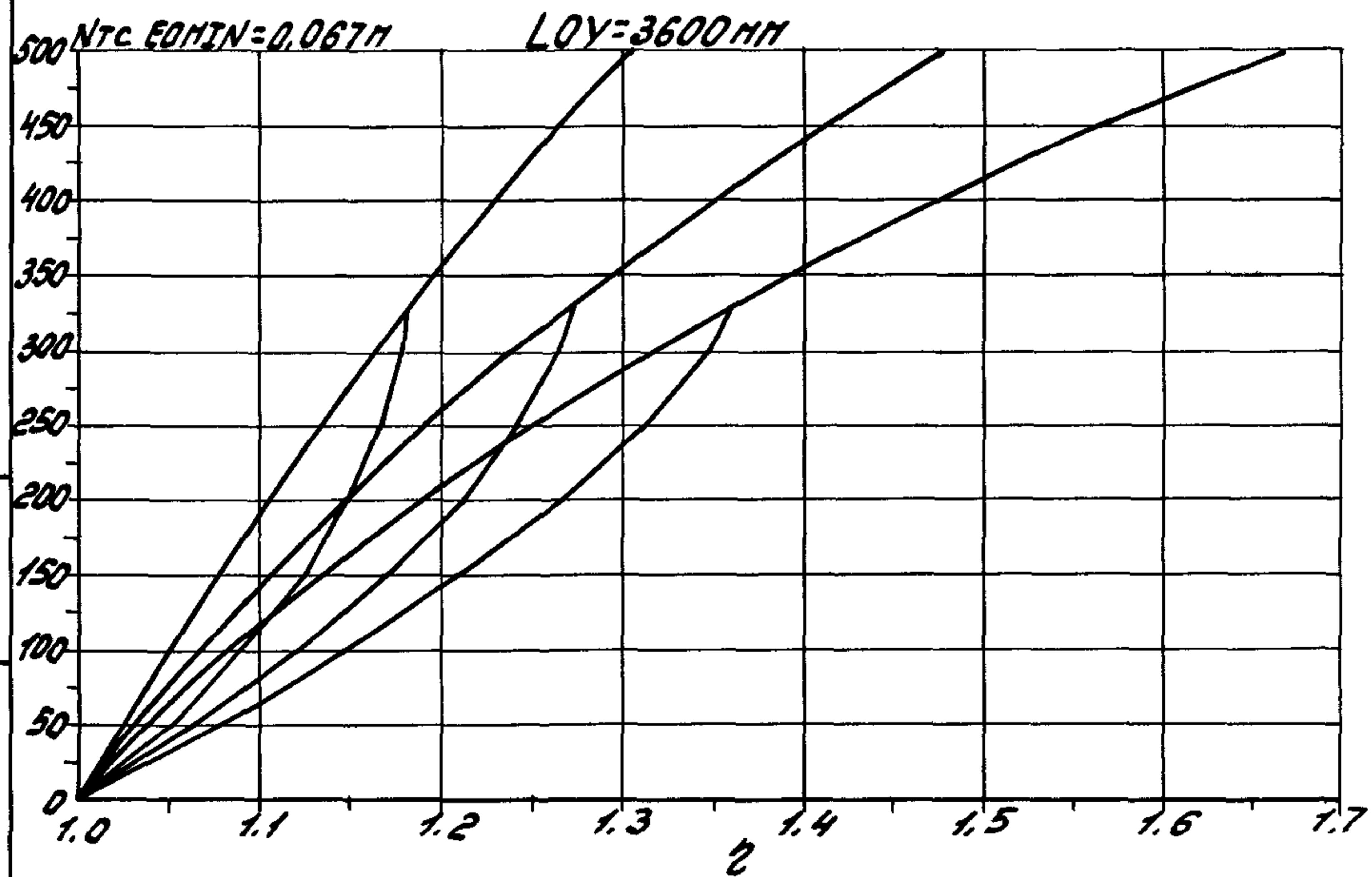
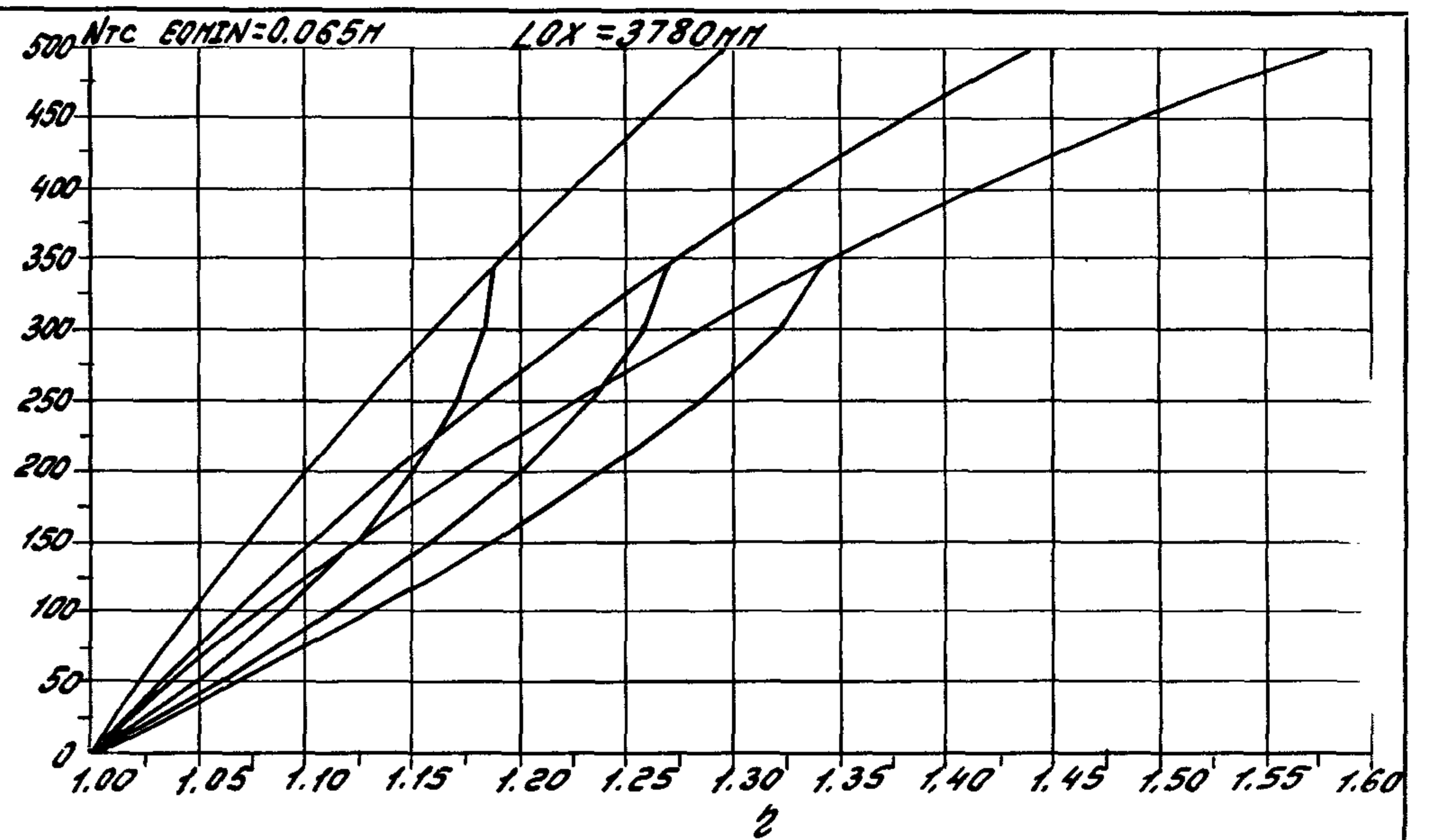
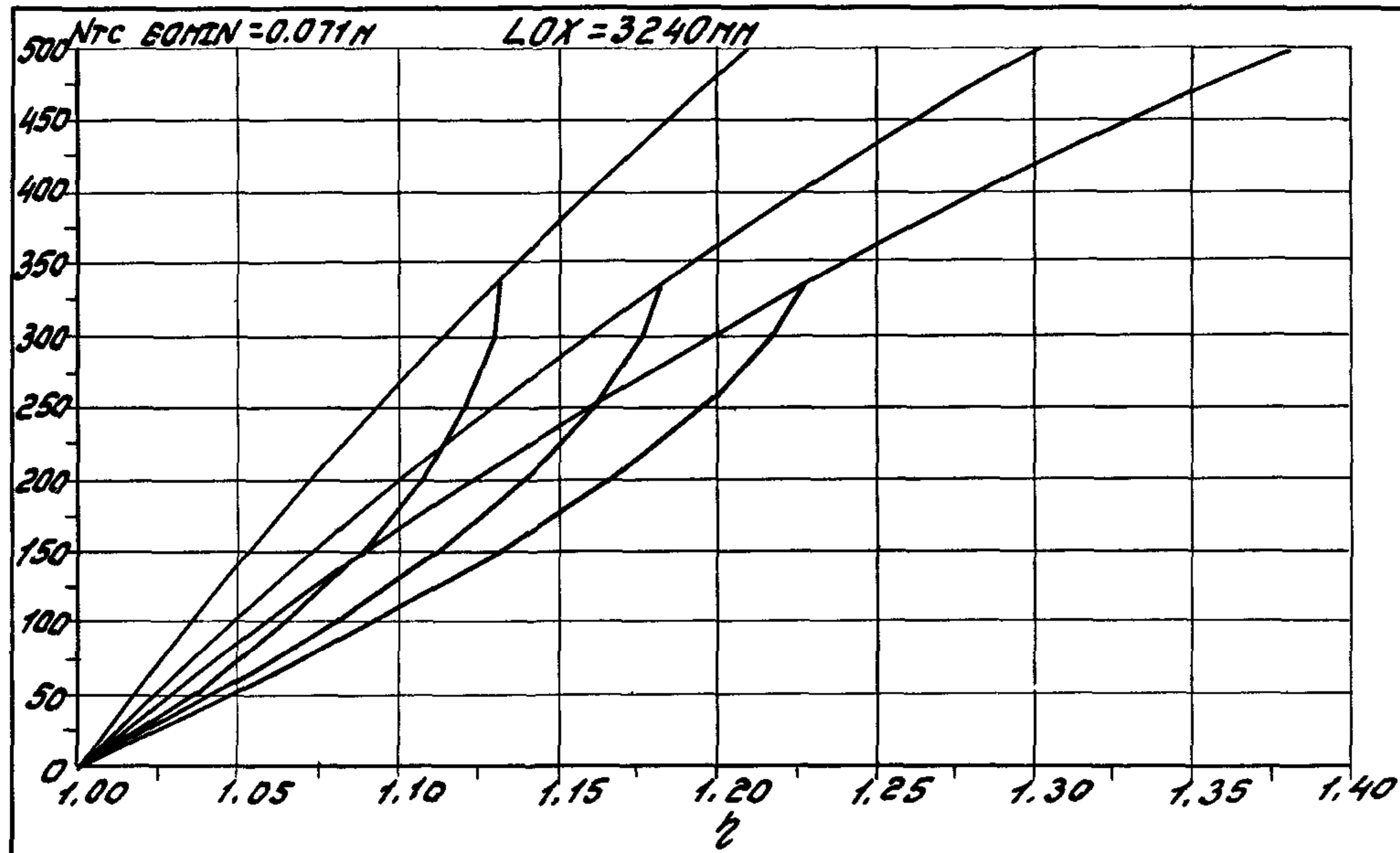

Шиф. и номер Подпись и дата Взам. инв.

1.020.1-4 0-9 002 Лист
162

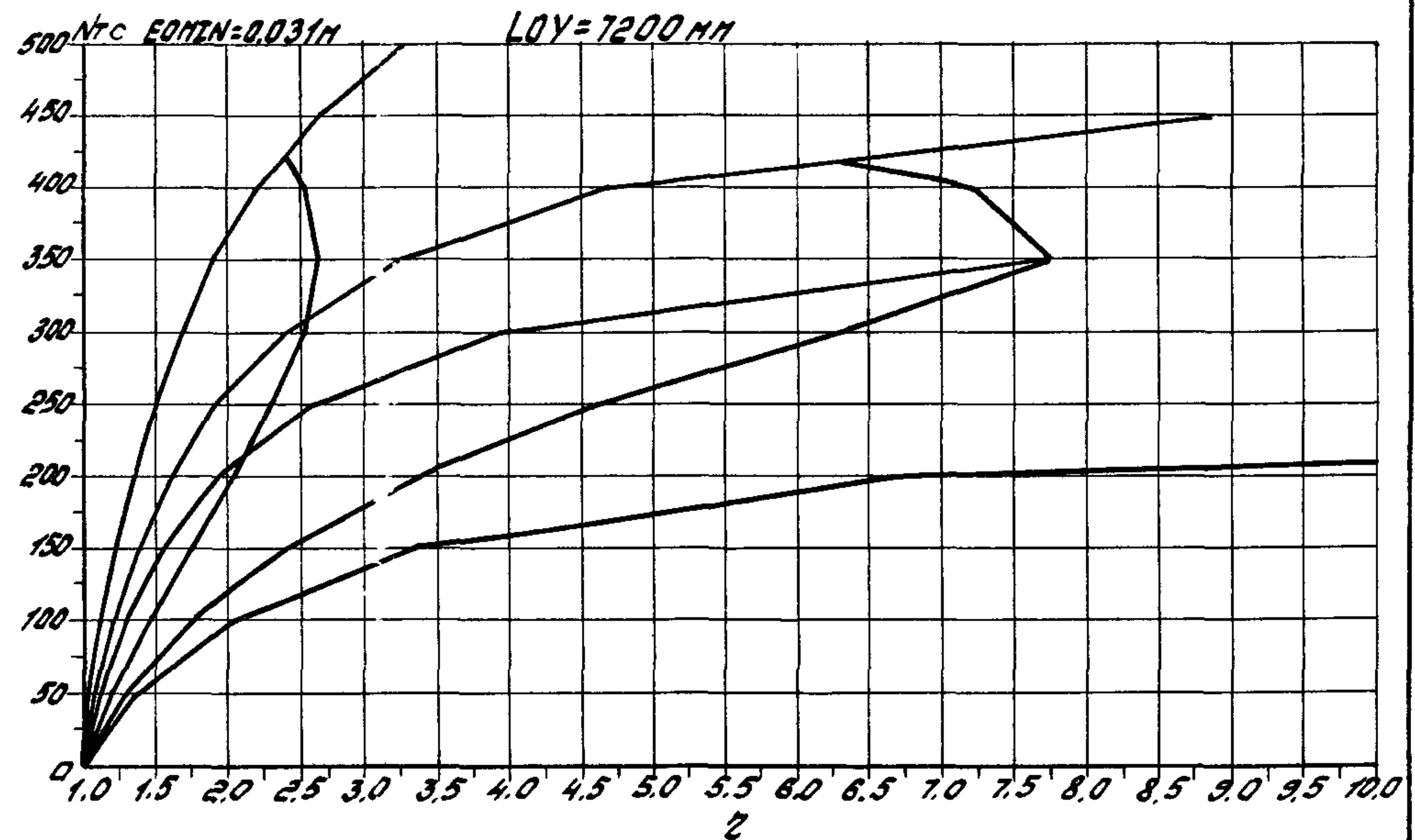
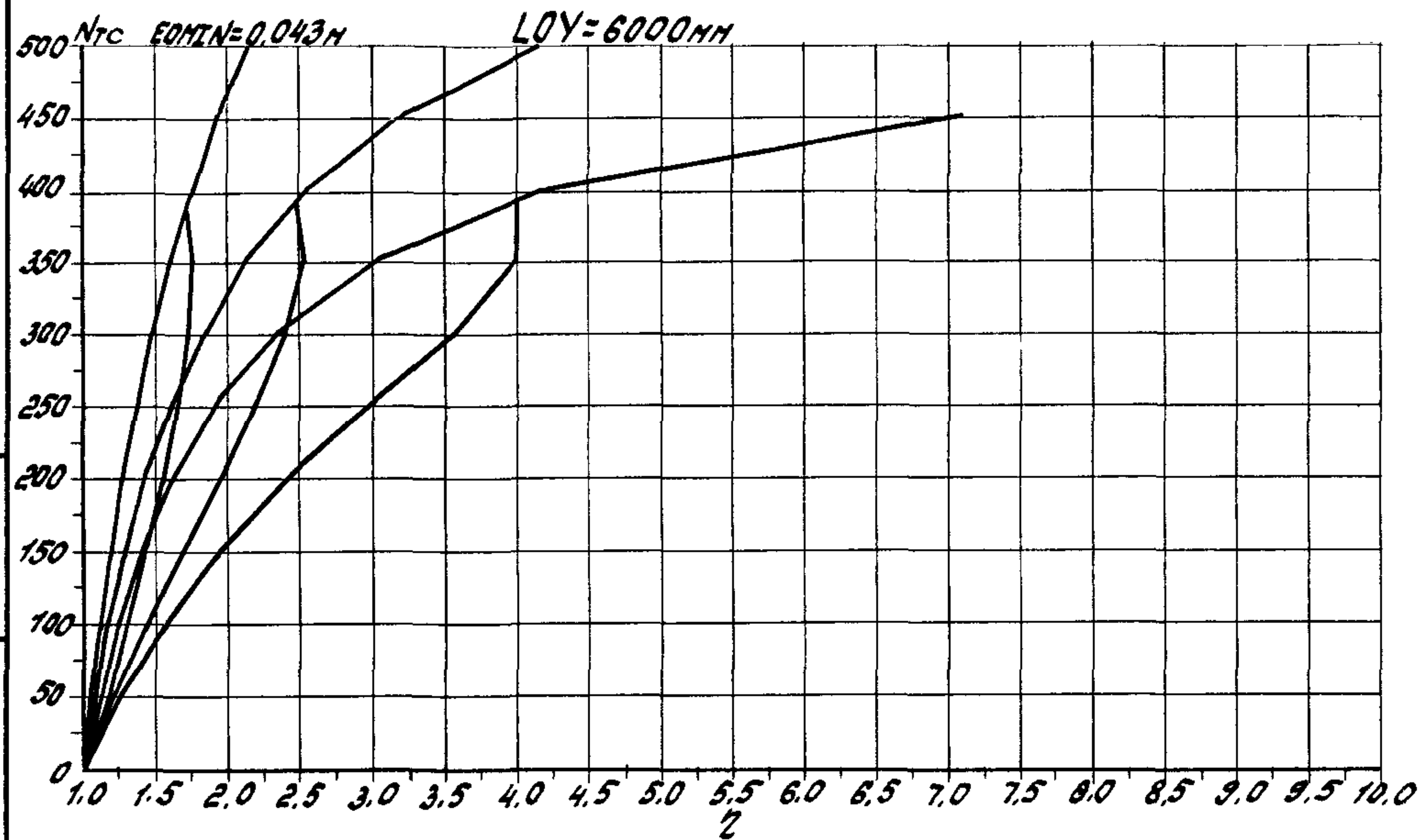
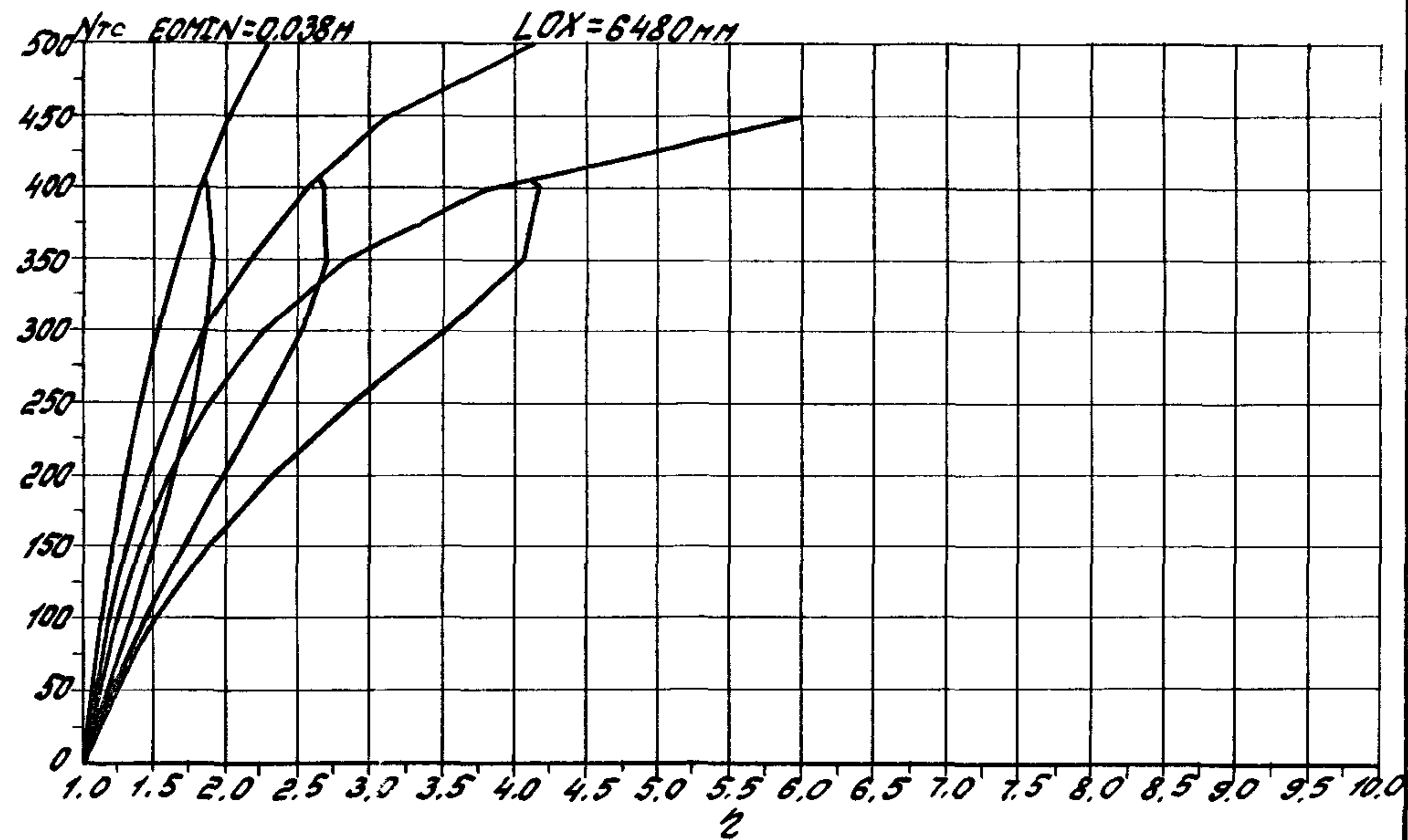
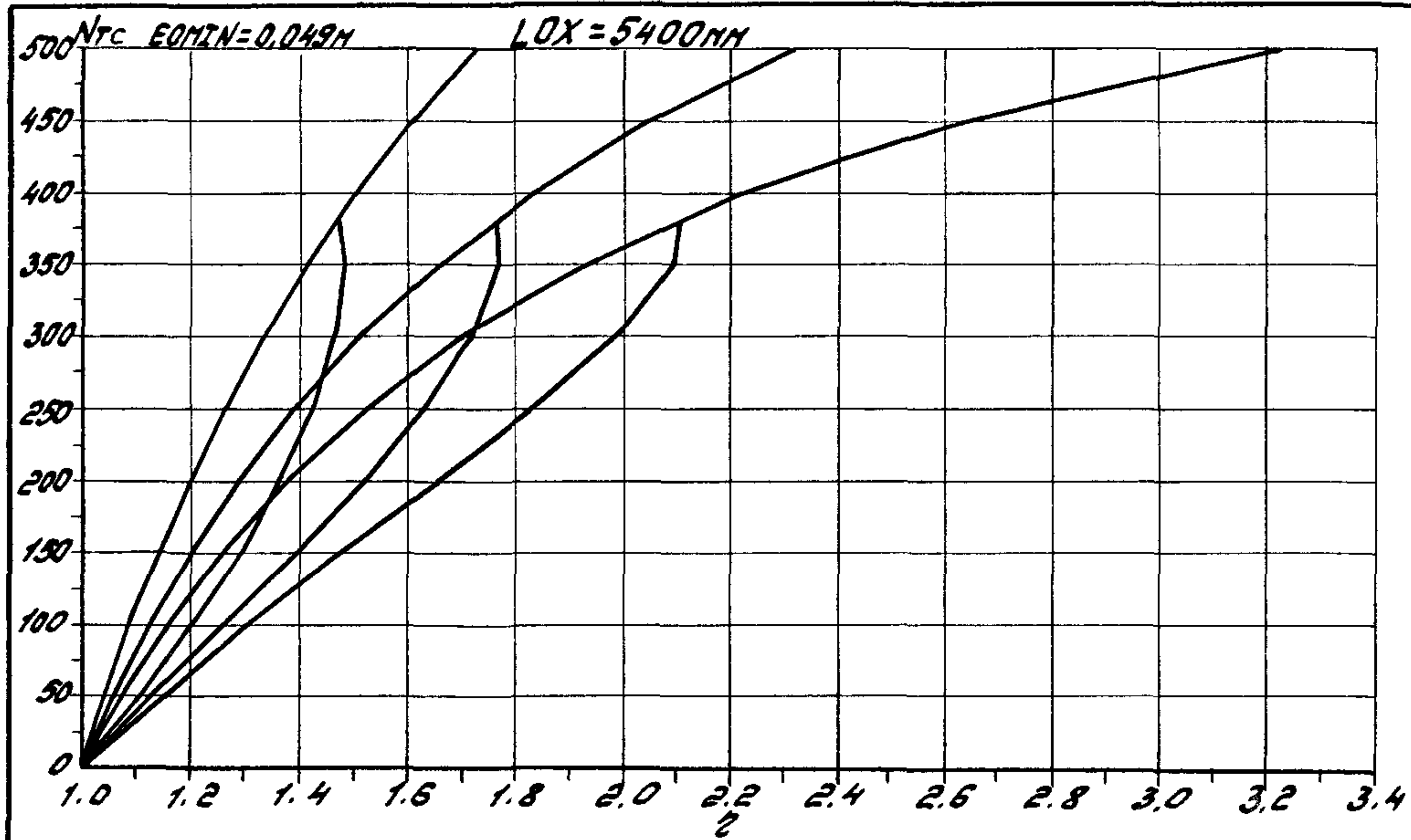

Учб. по спец. технике в форме экз. учеб. н.м.

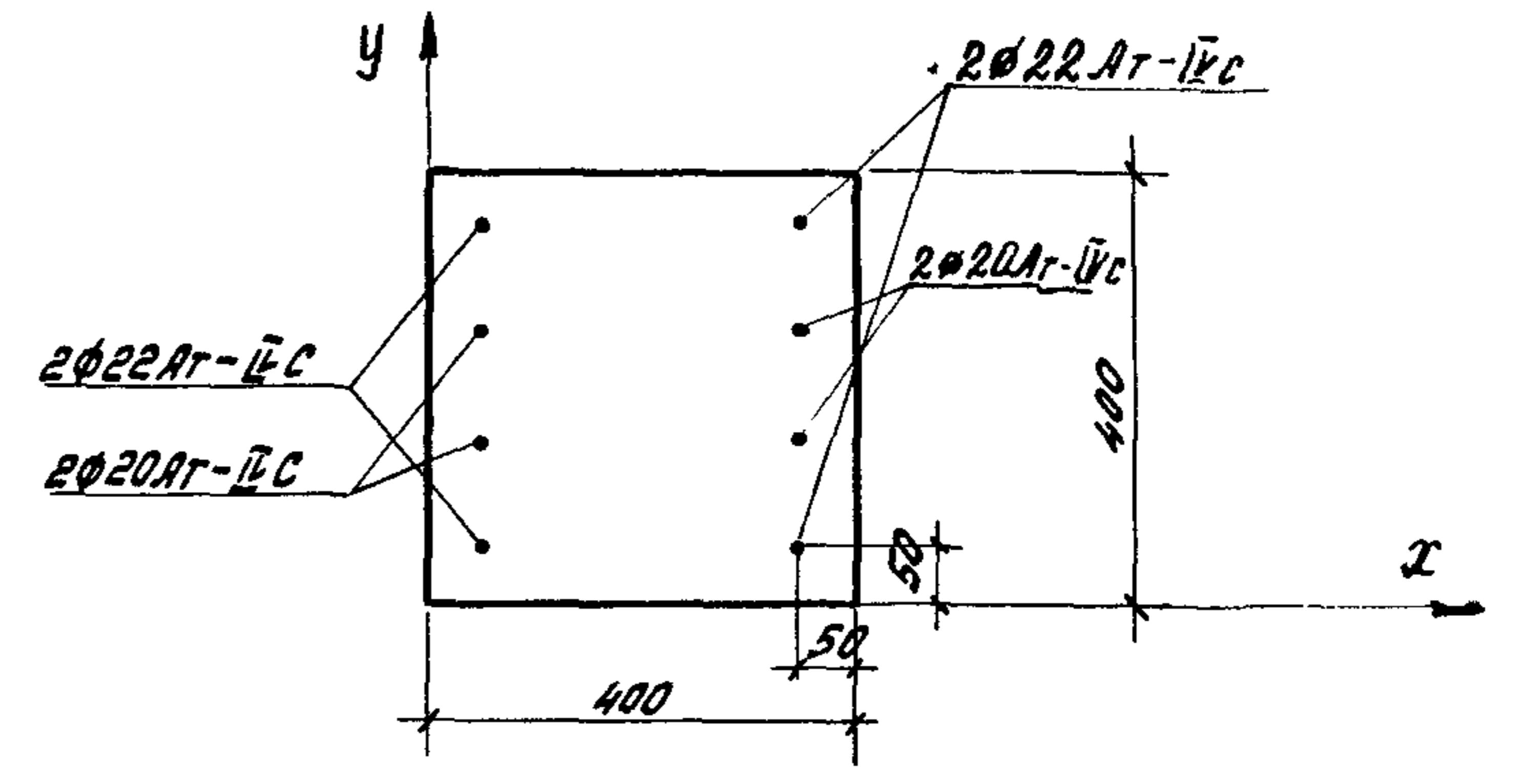
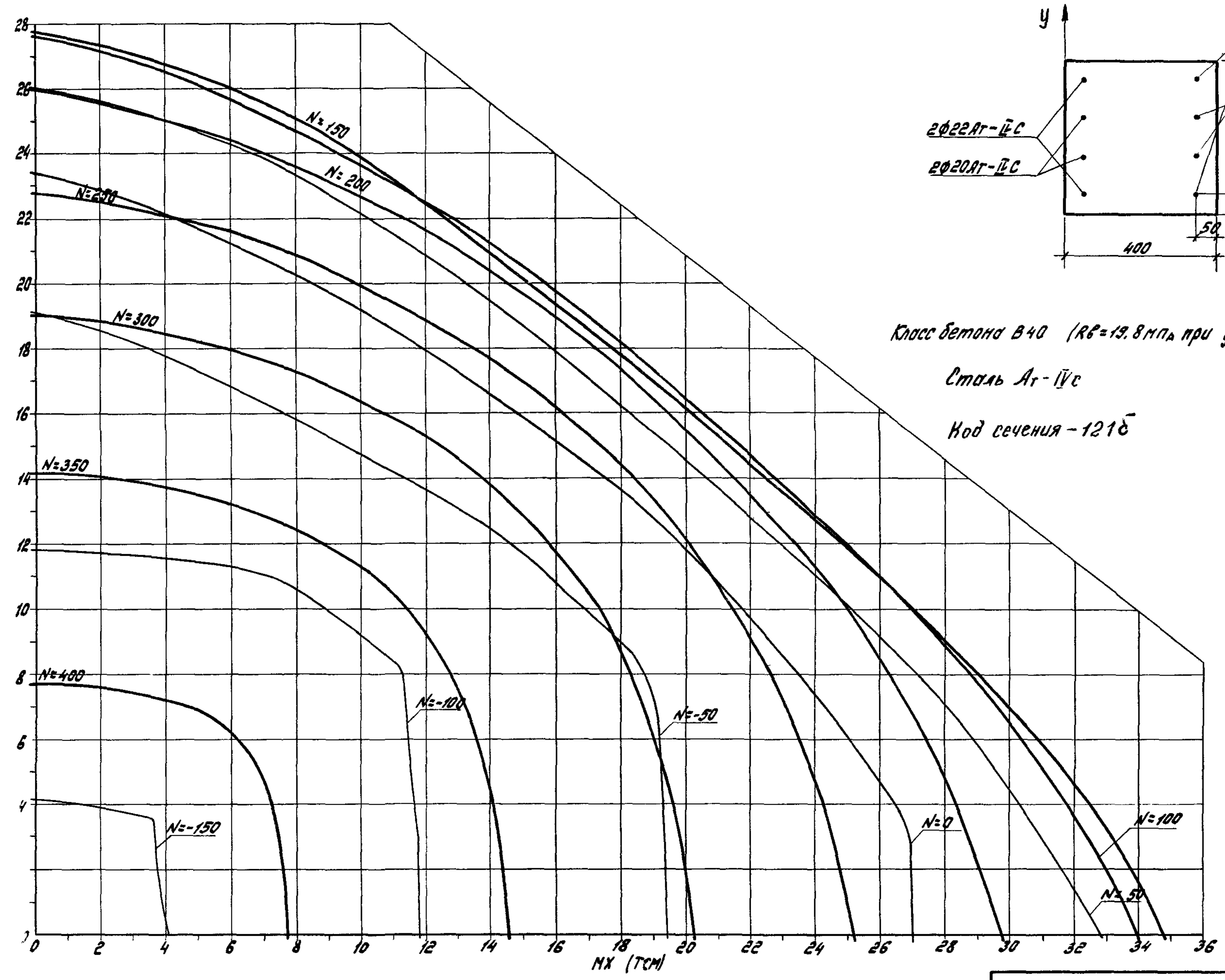

Класс бетона В40 ($R_b = 19.8 \text{ МПа}$ при учете $\gamma_{b2} = 0.90$)
 Сталь Ar-IVc
 Код сечения - 121б

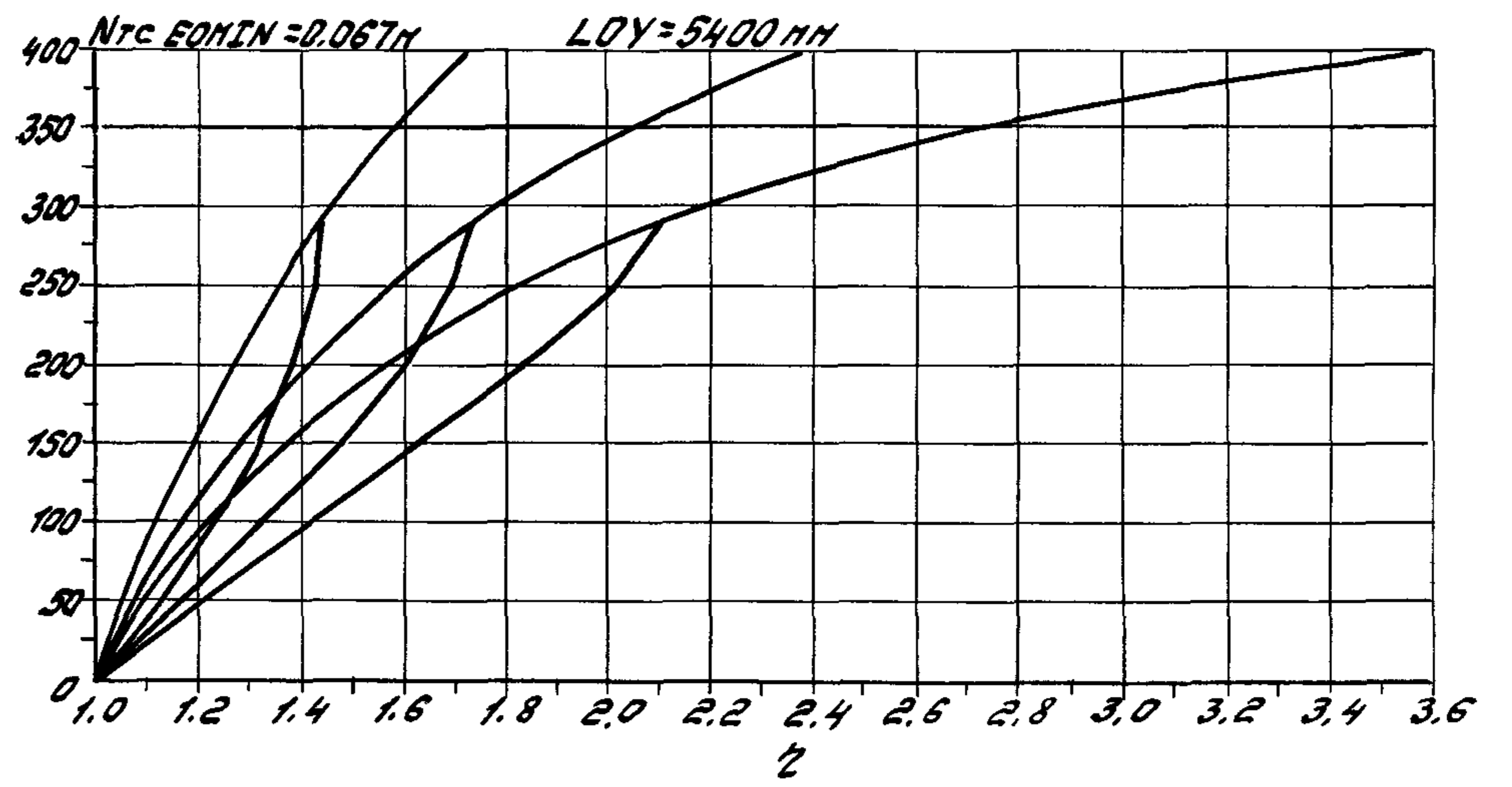
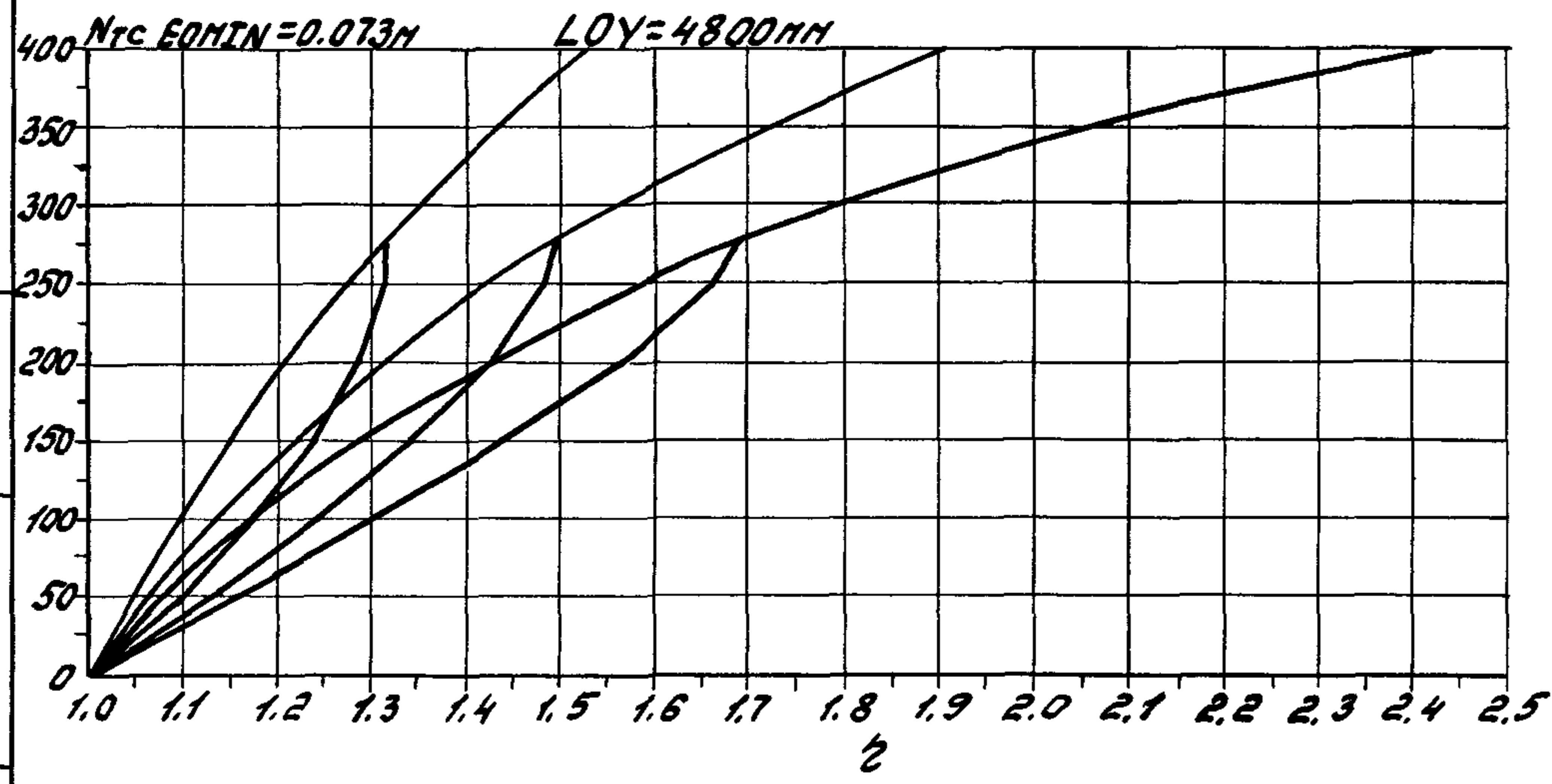
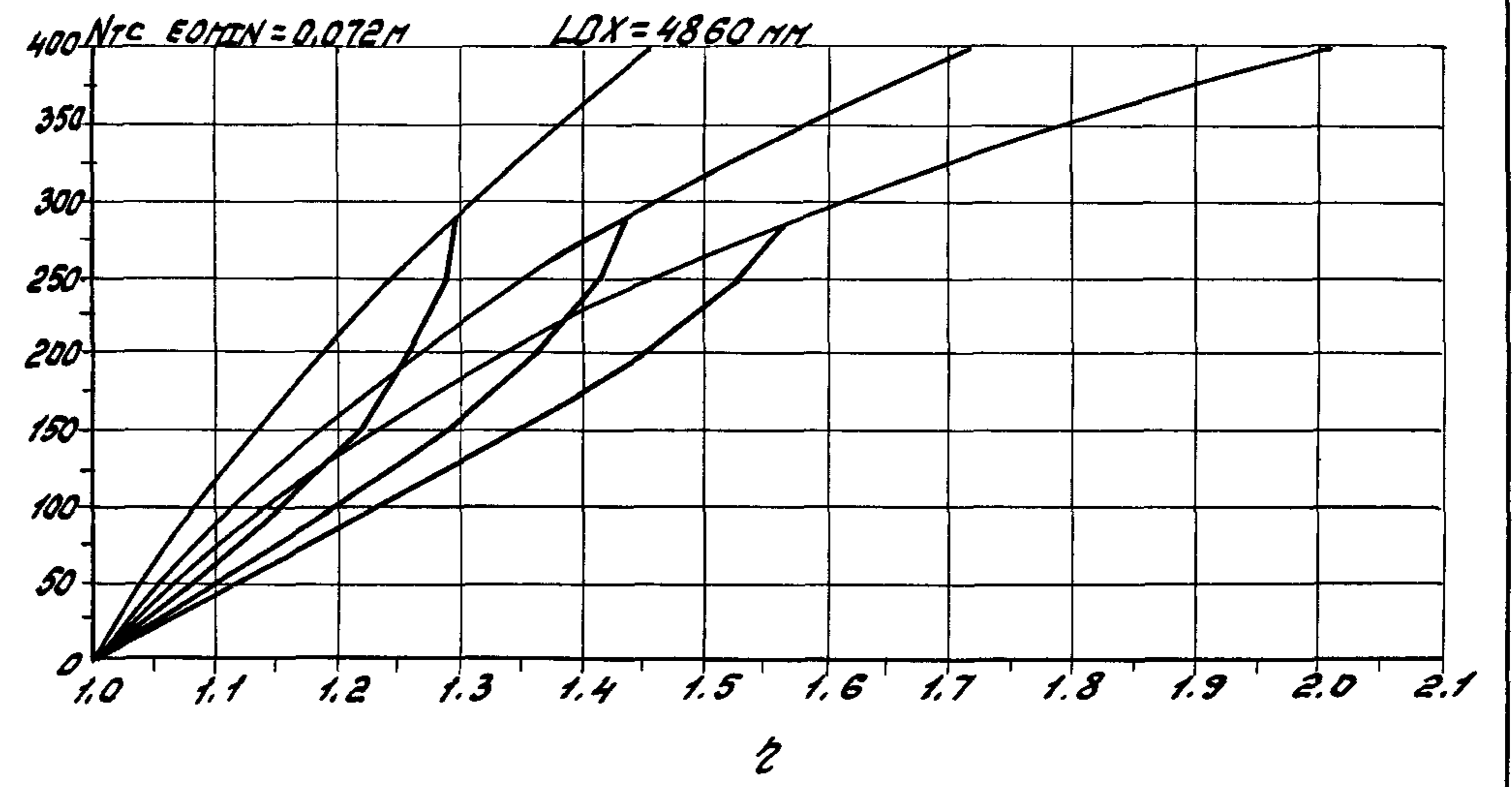
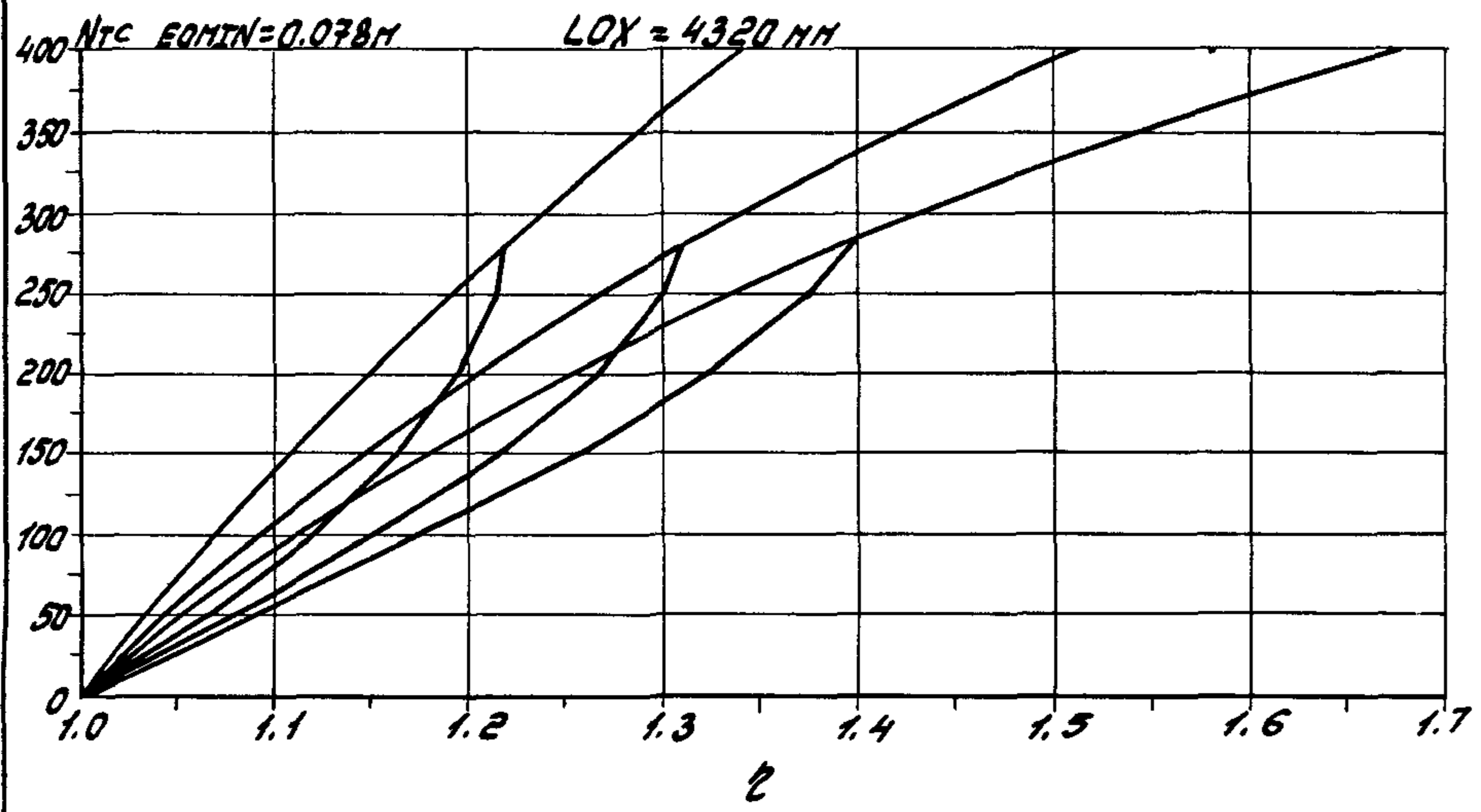

Водяная в паровозном котле

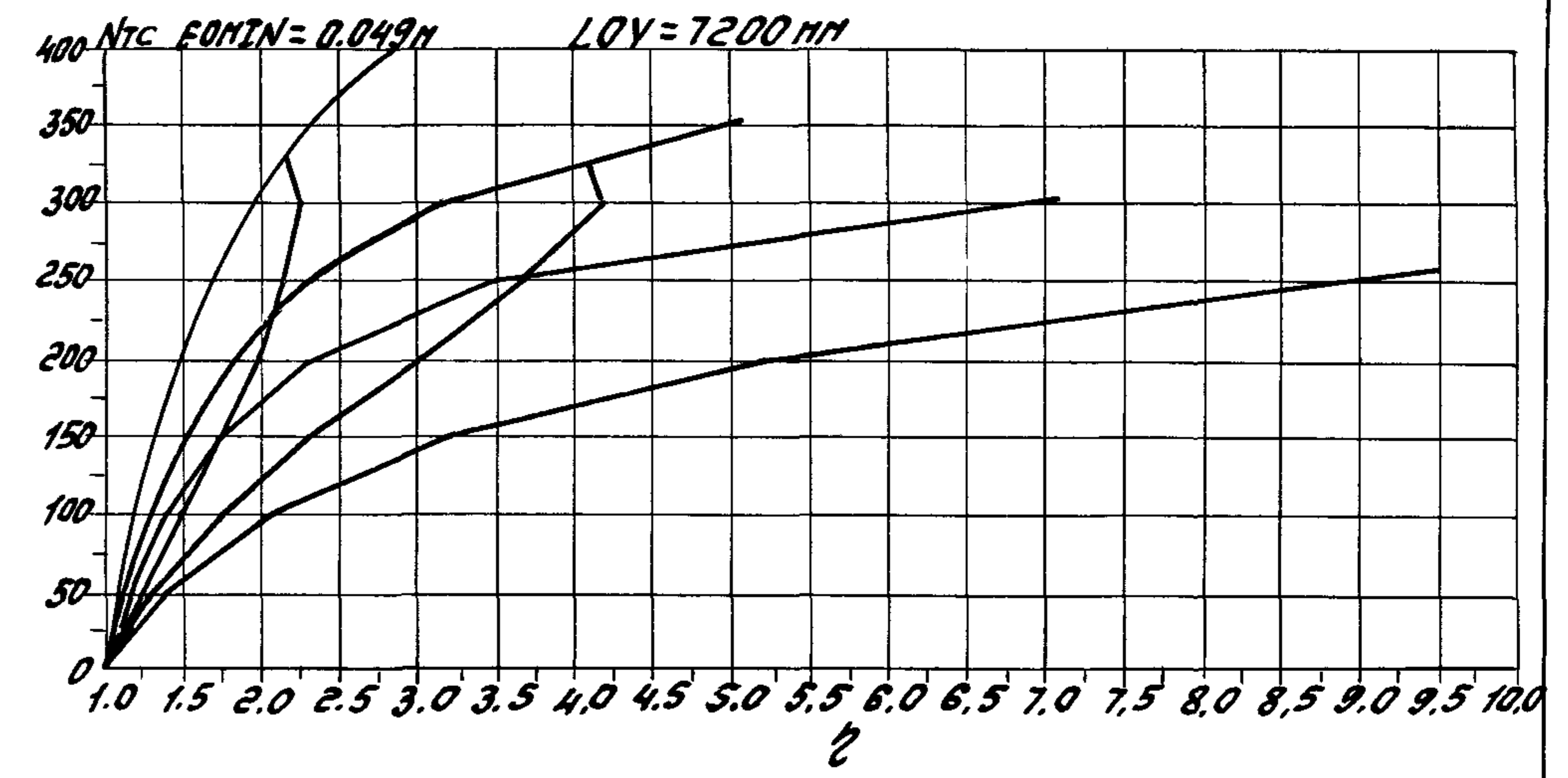
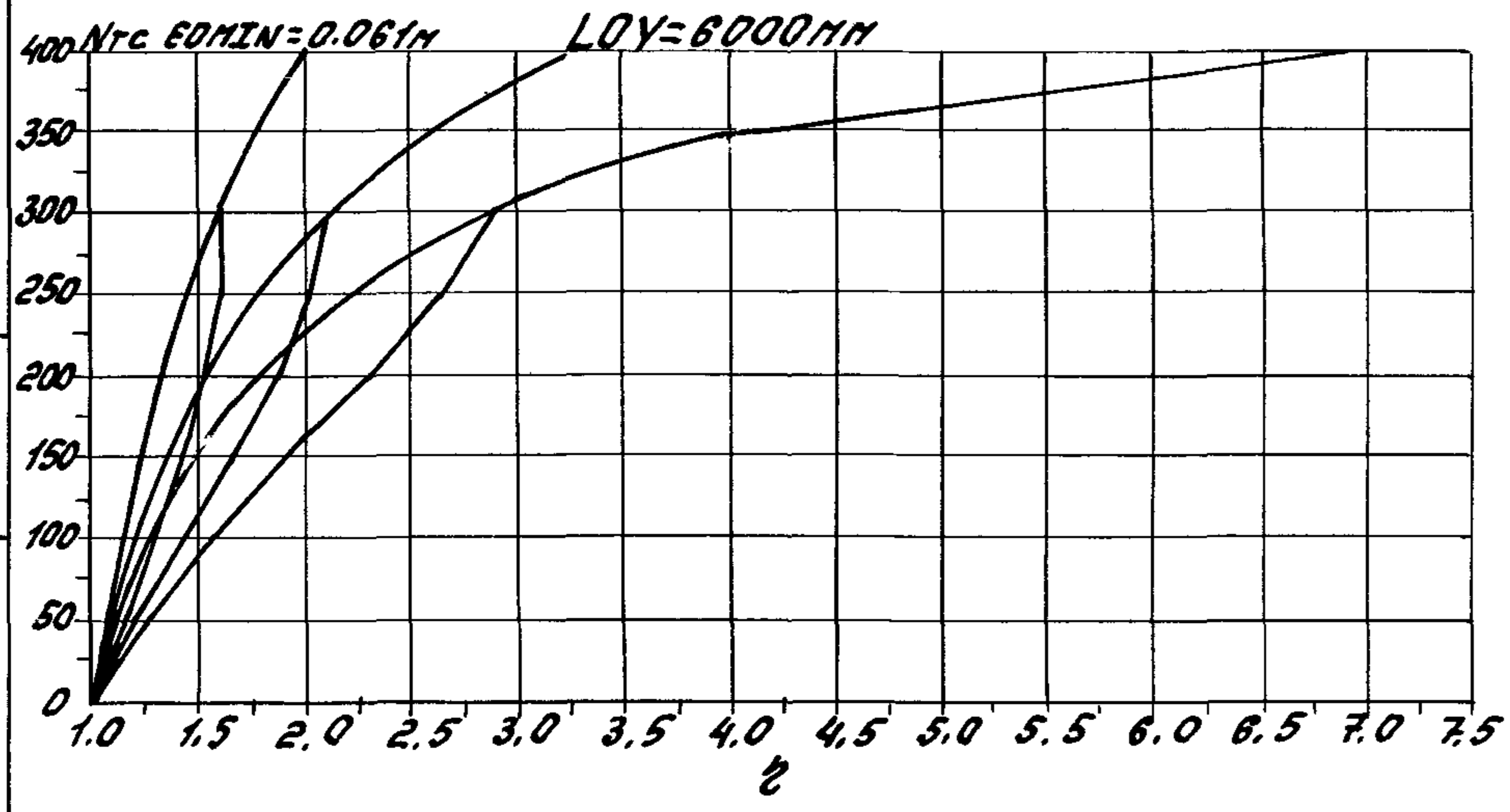
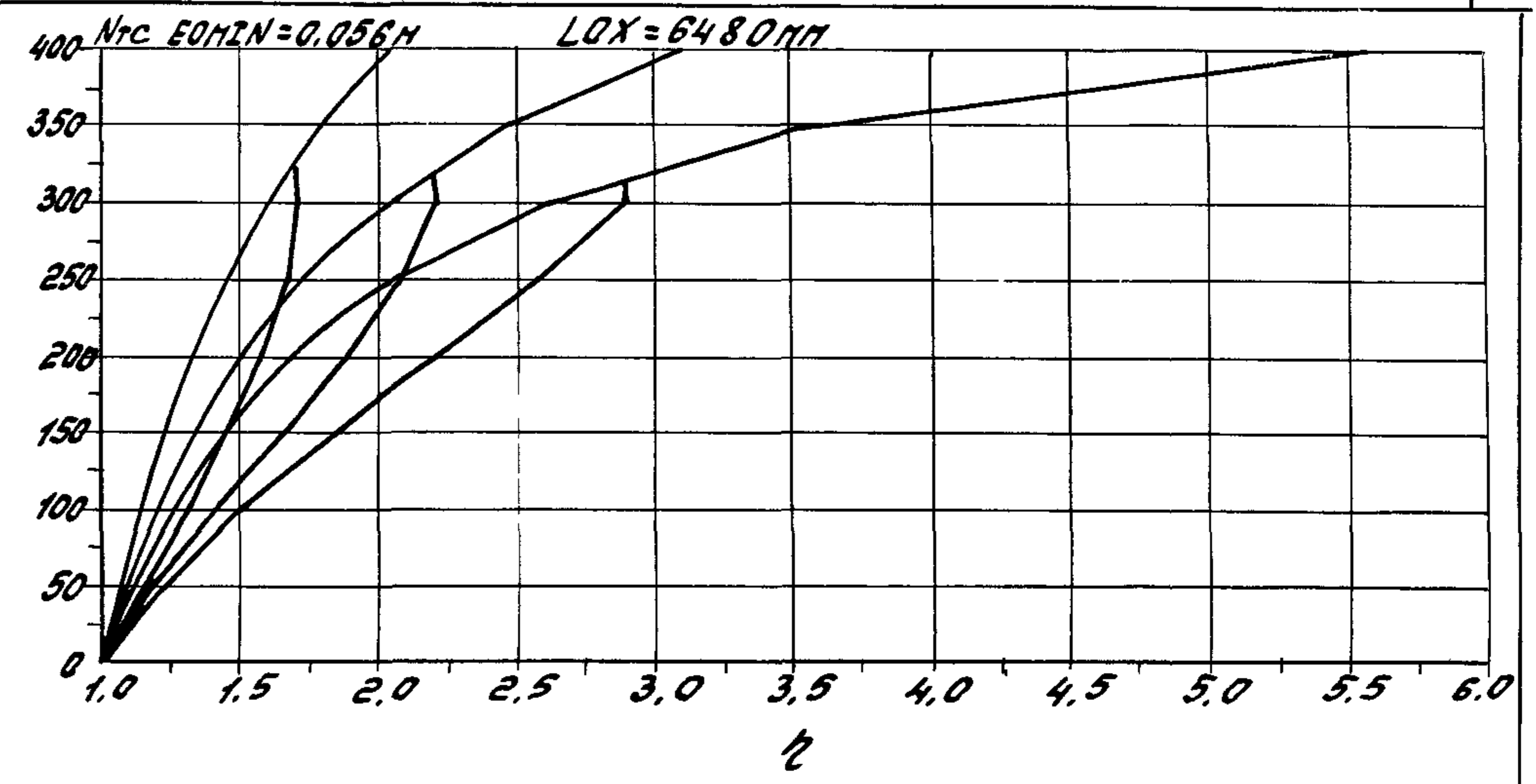
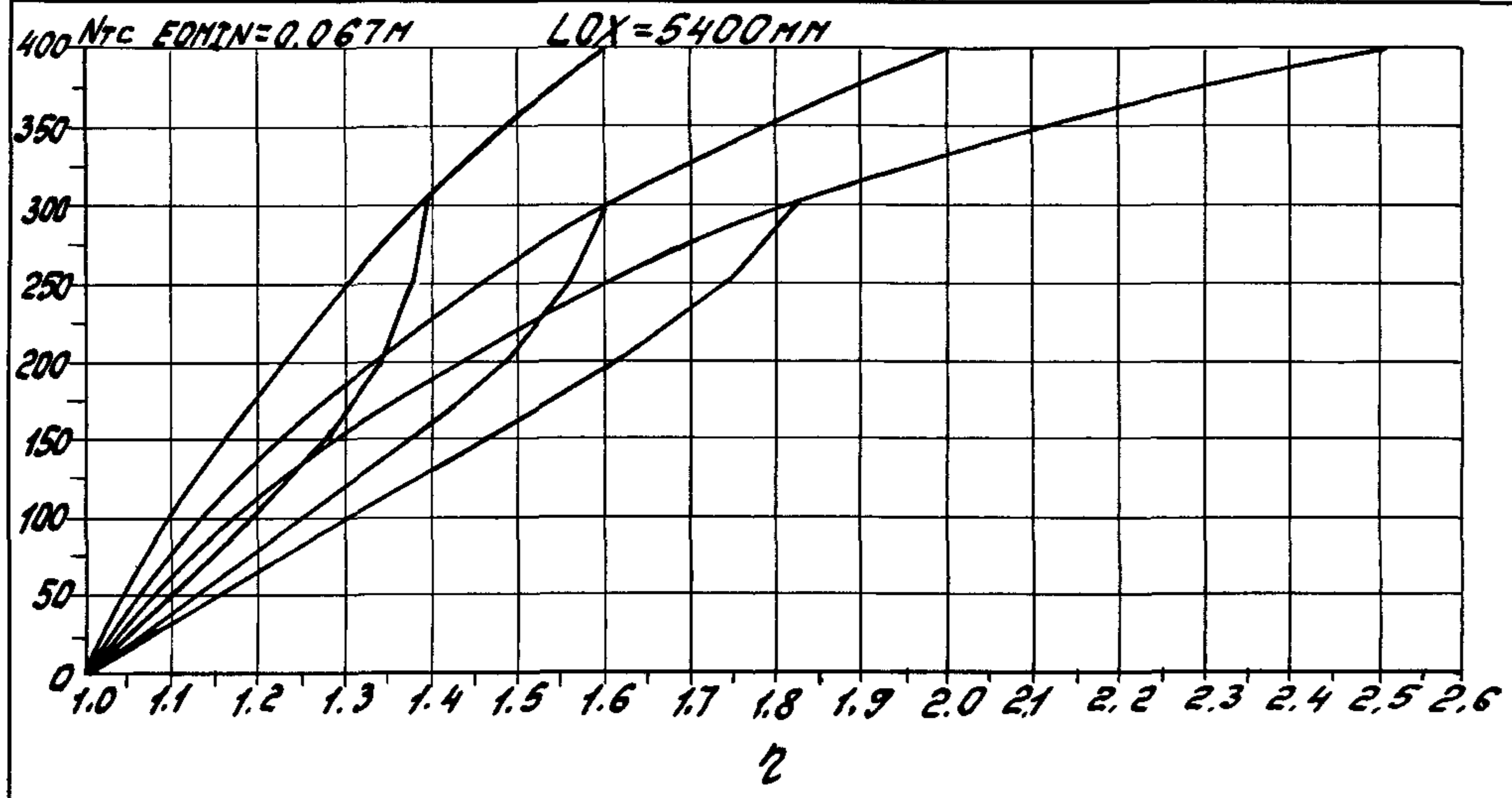

Инв. №подл. Подпись и дата Взам. Инв. №

1.020.1-4 0-9 002 188

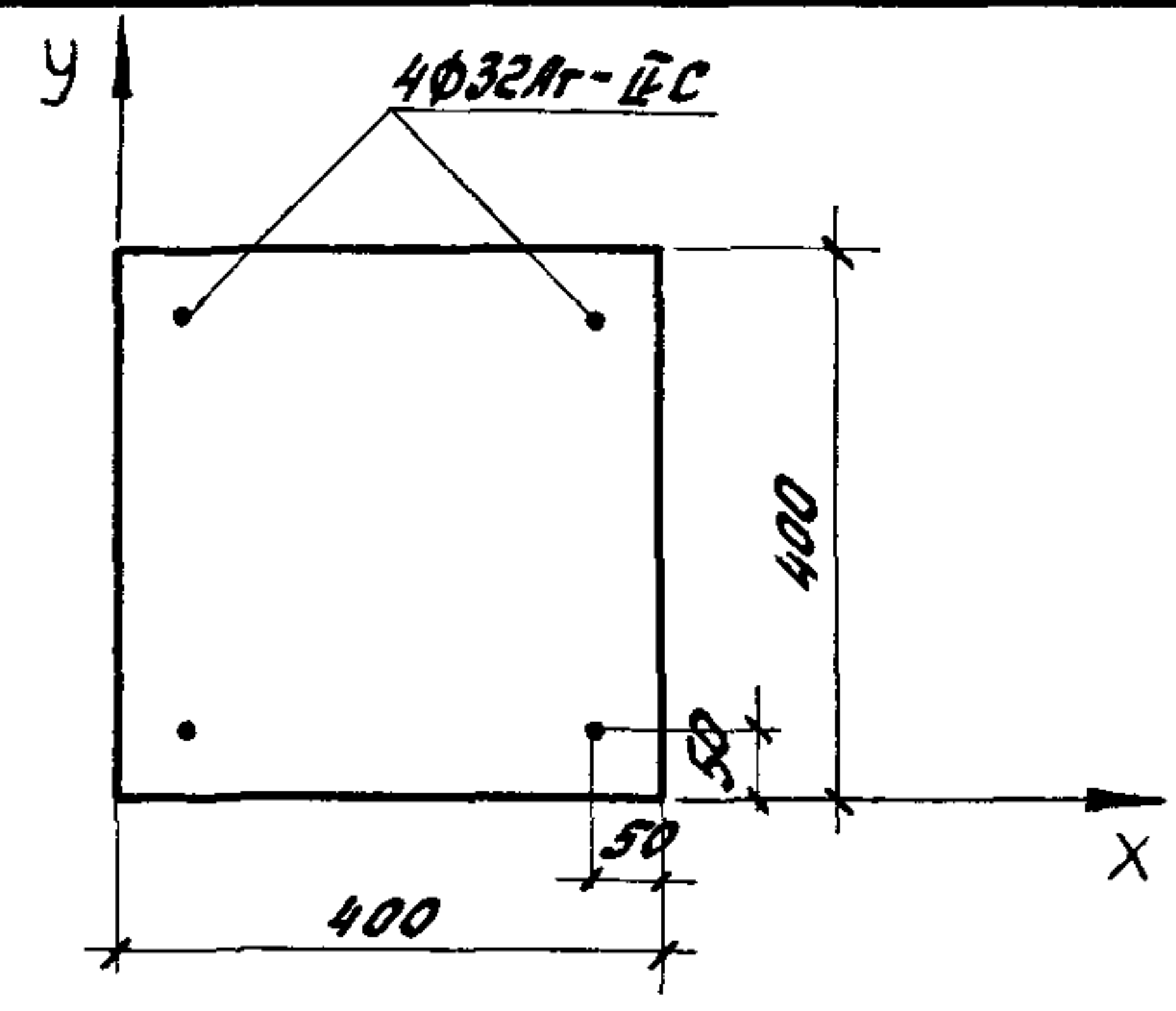
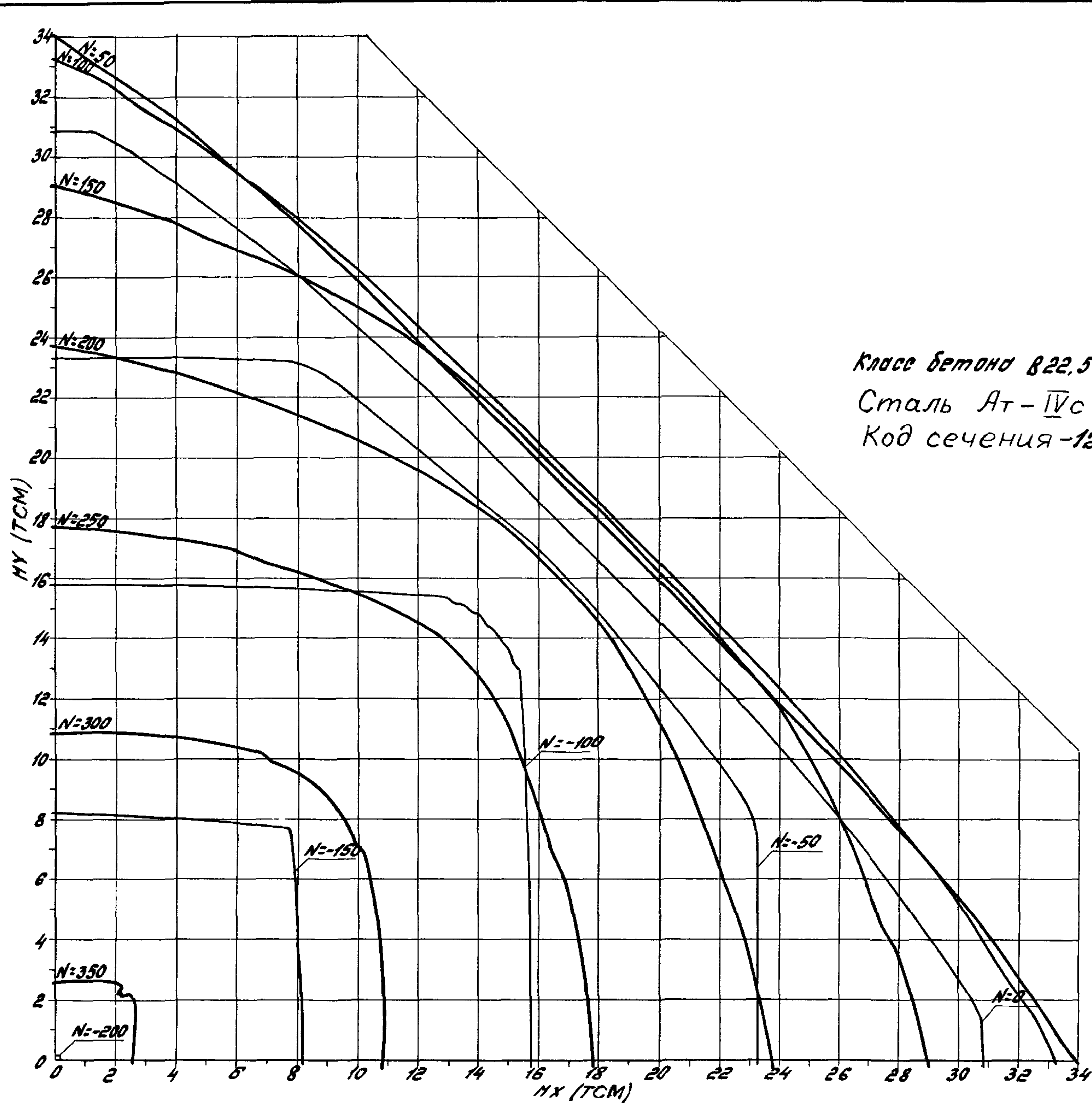

Класс бетона В22,5 ($R_b = 14.3 \text{ МПа}$ при учёте $\gamma_{b2} = 1.10$)
 Сталь Ат-IVс
 Код сечения -122а

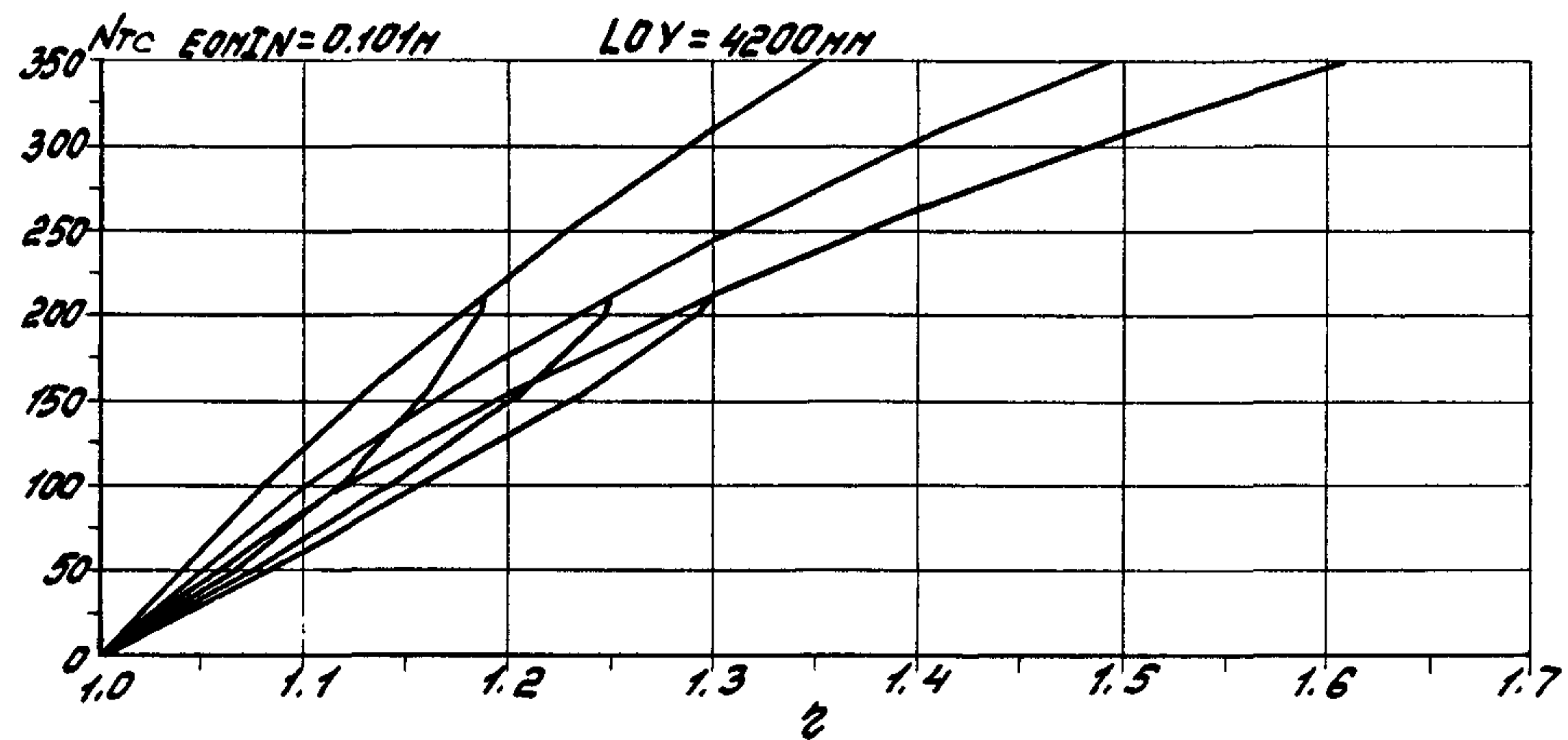
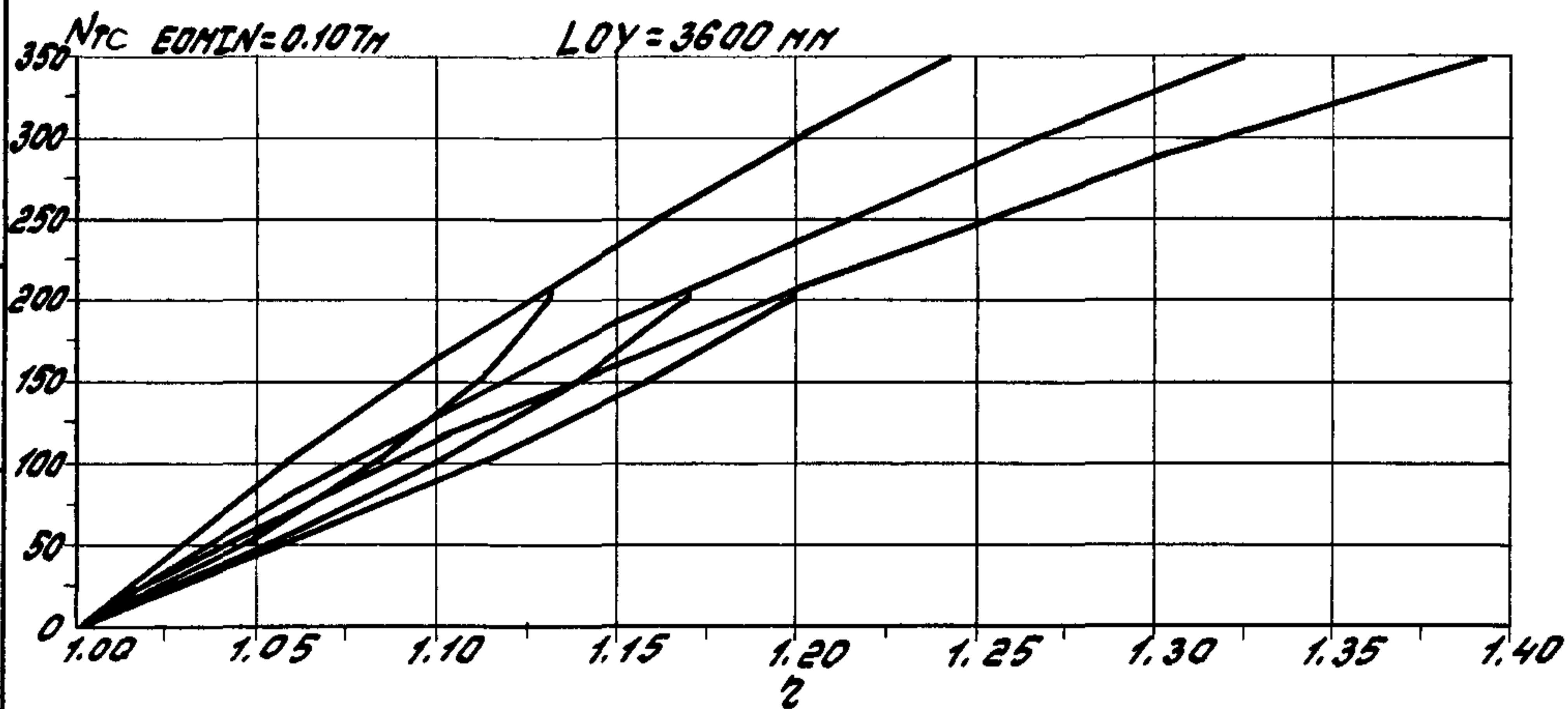
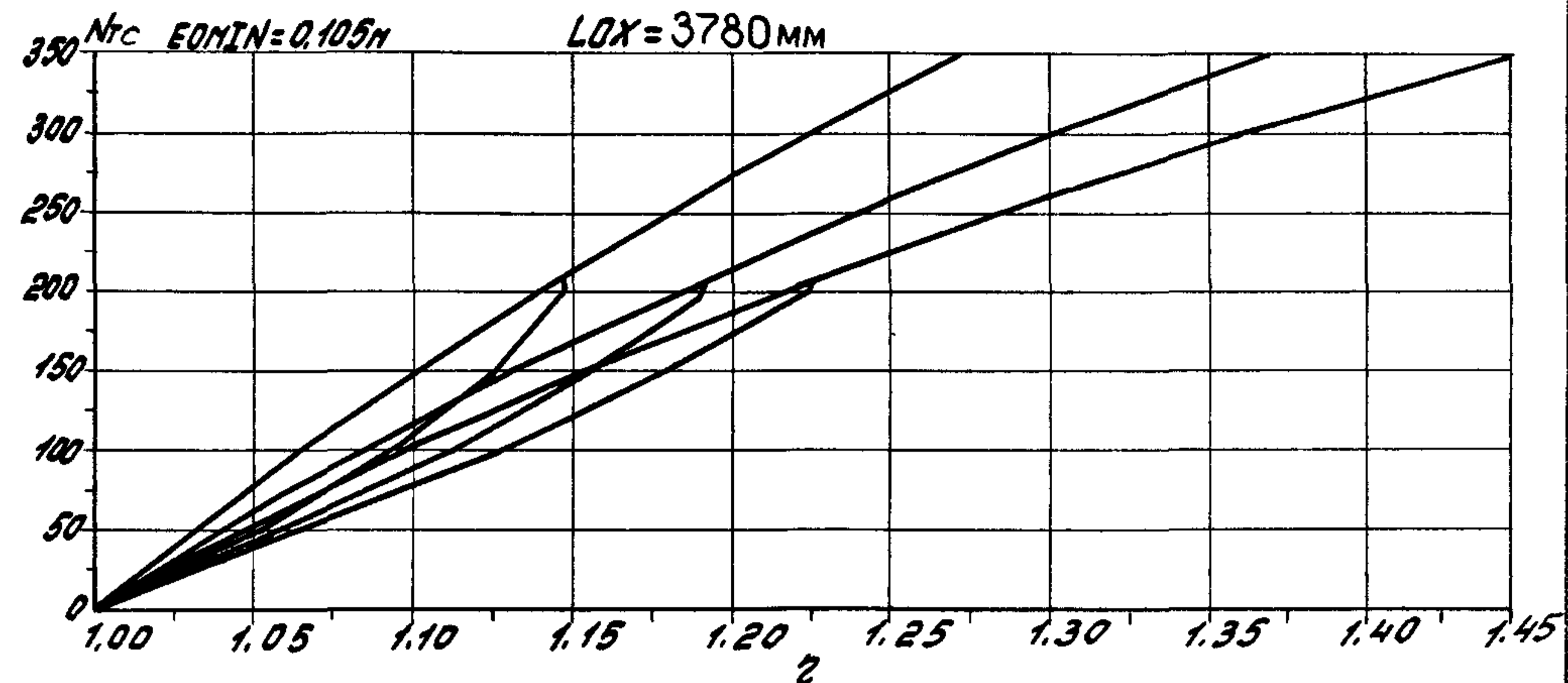
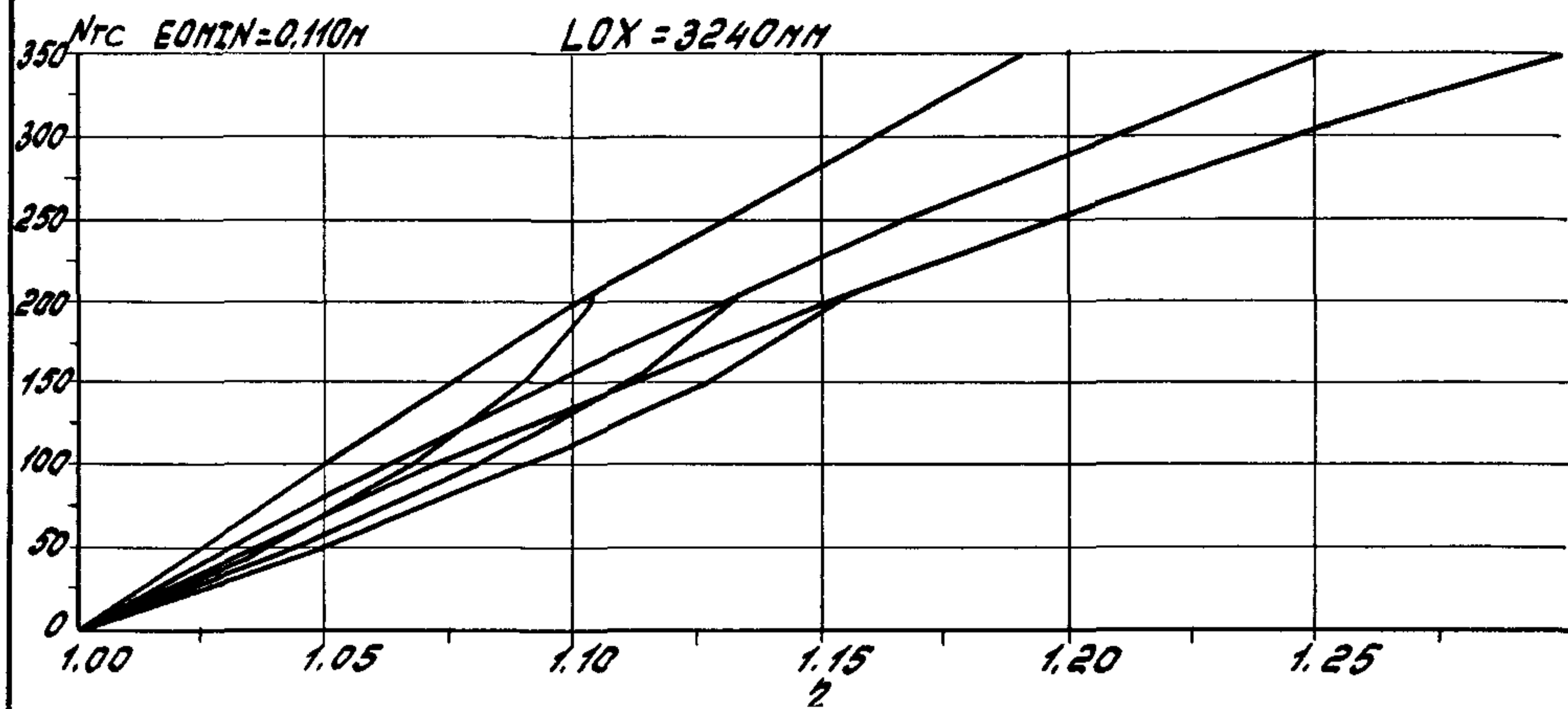

ЧИБ. N-10 подл. Испытание в объеме 0.30H. ЧИБ. N

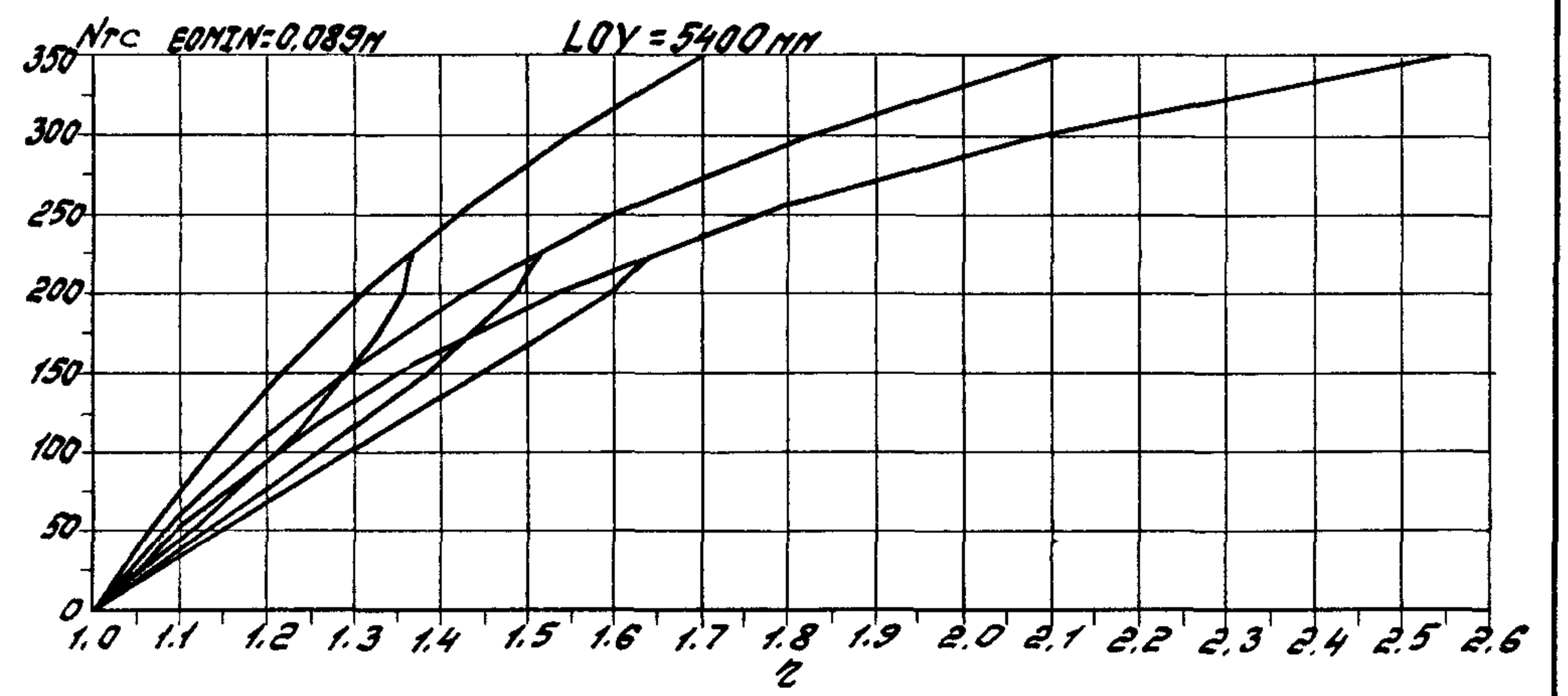
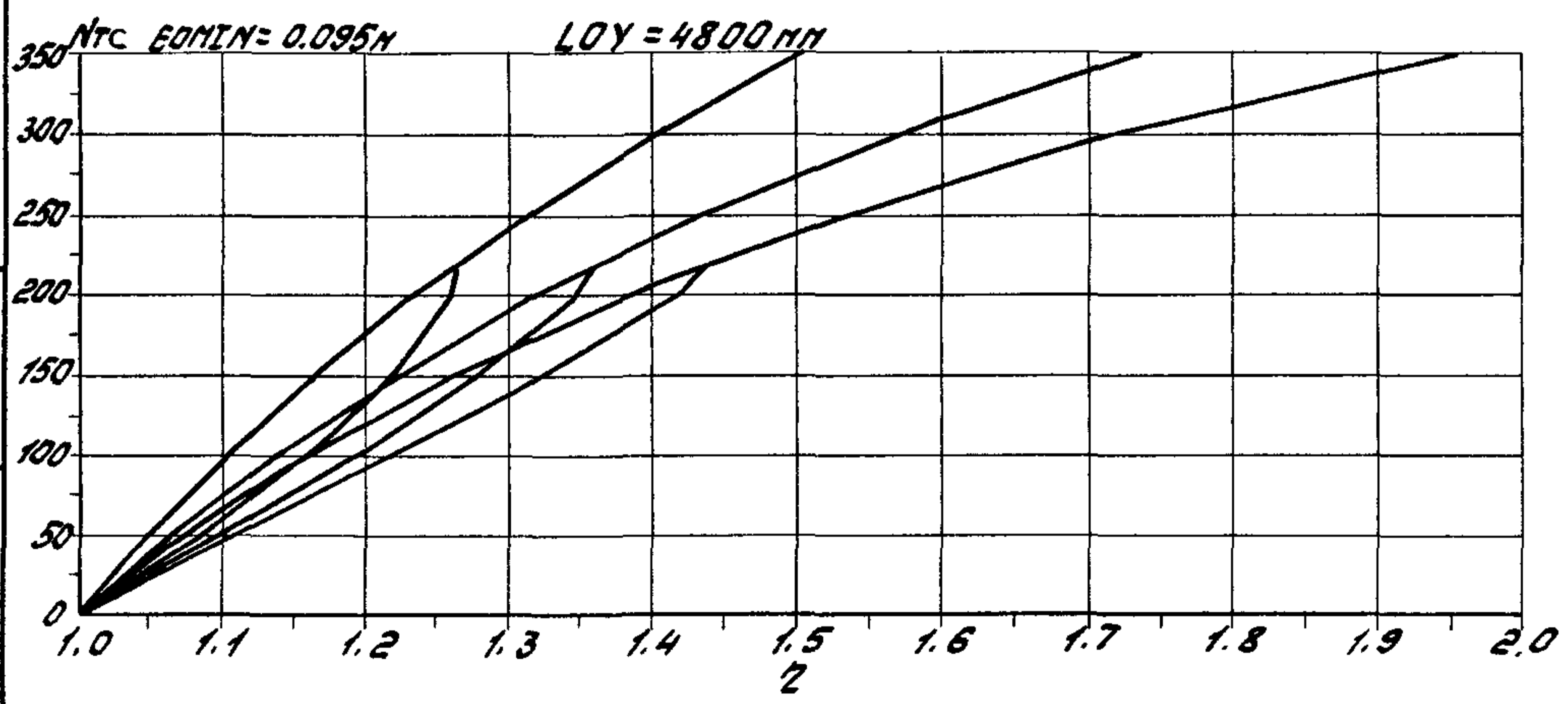
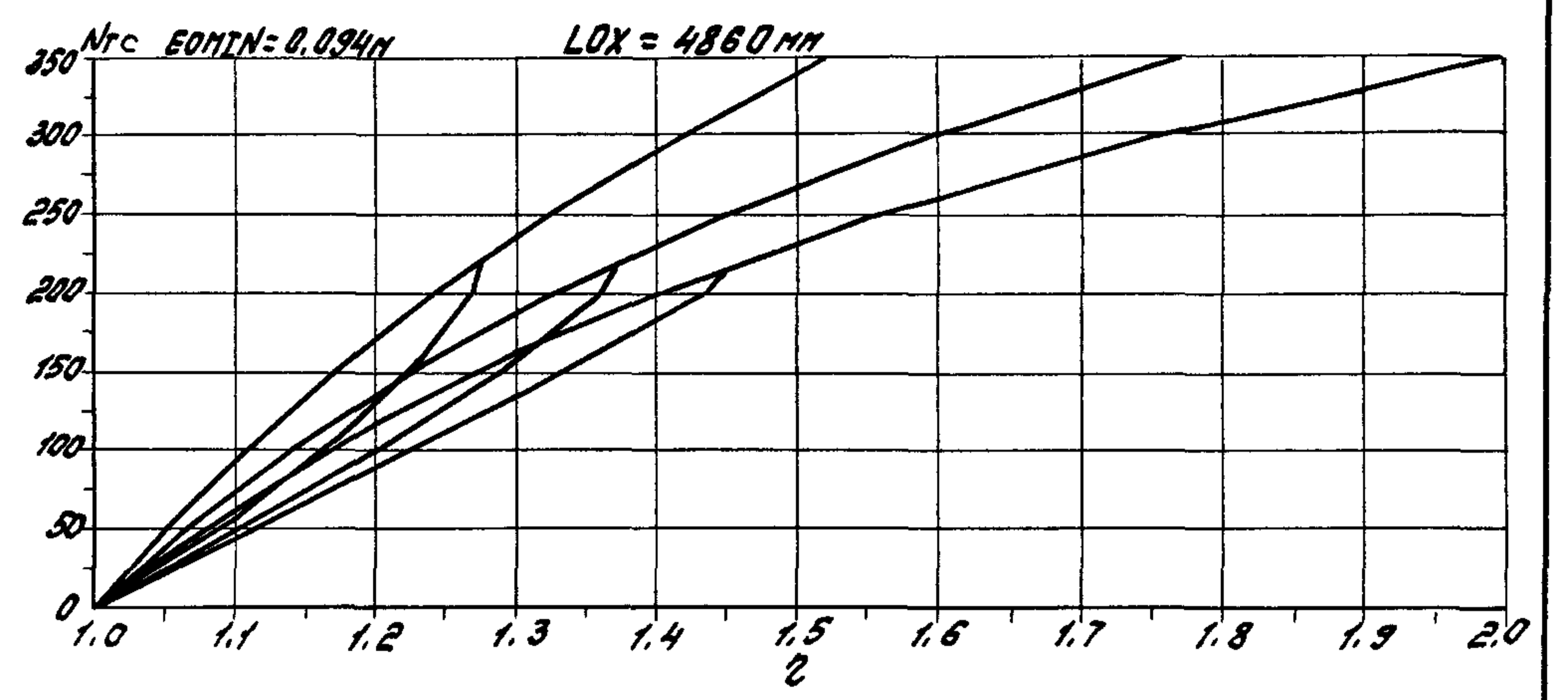
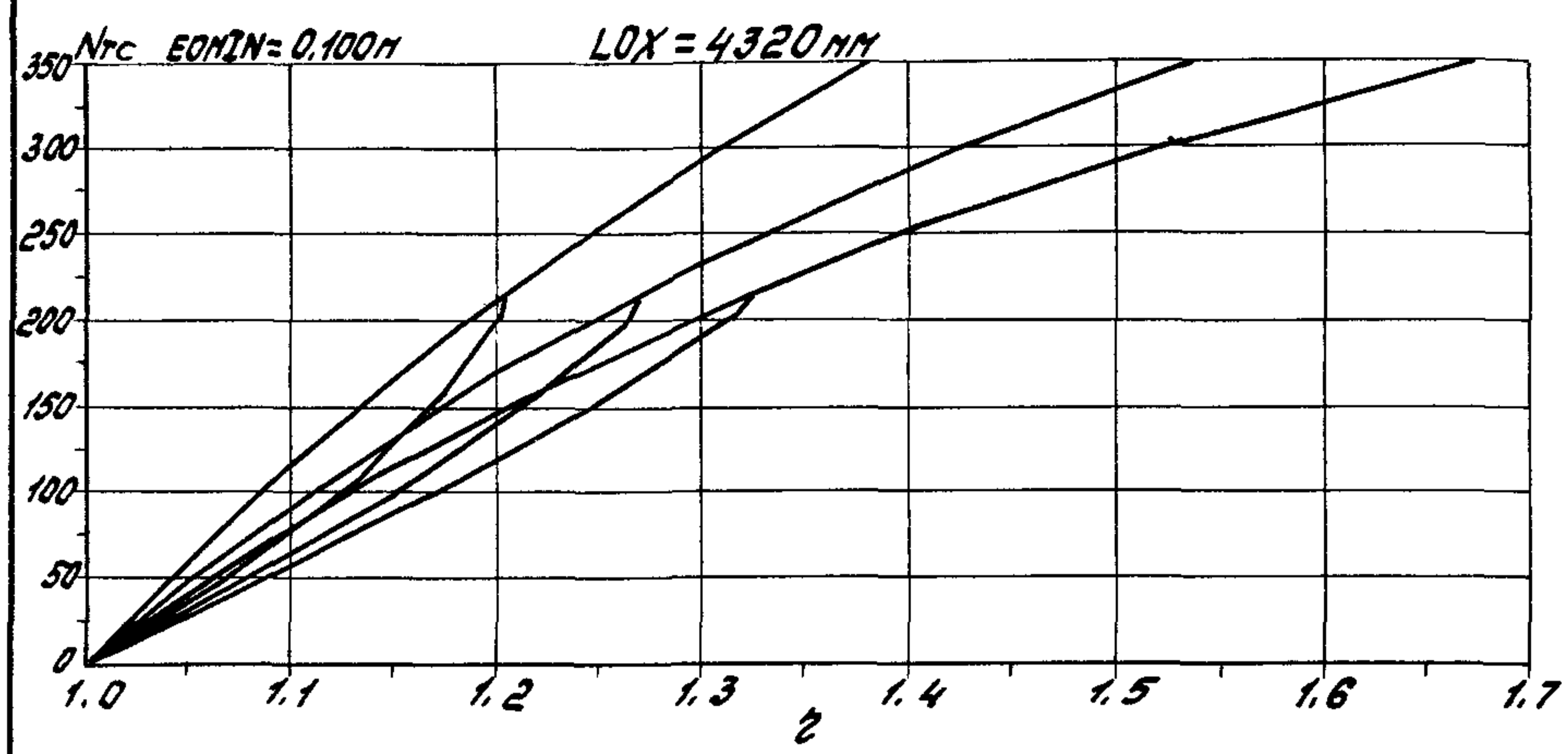

УИБ. № 1008. Подпис. У. Д. Ма. 130М. УИ.

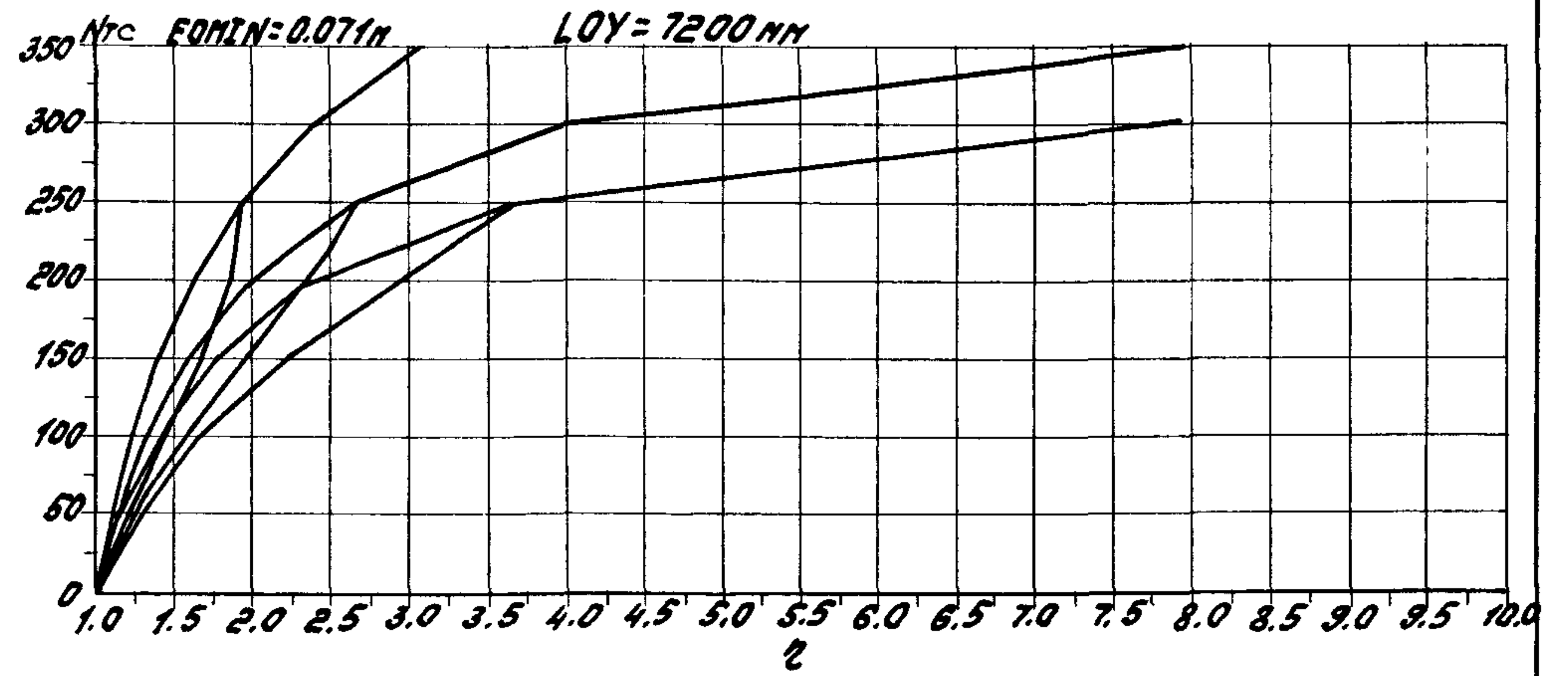
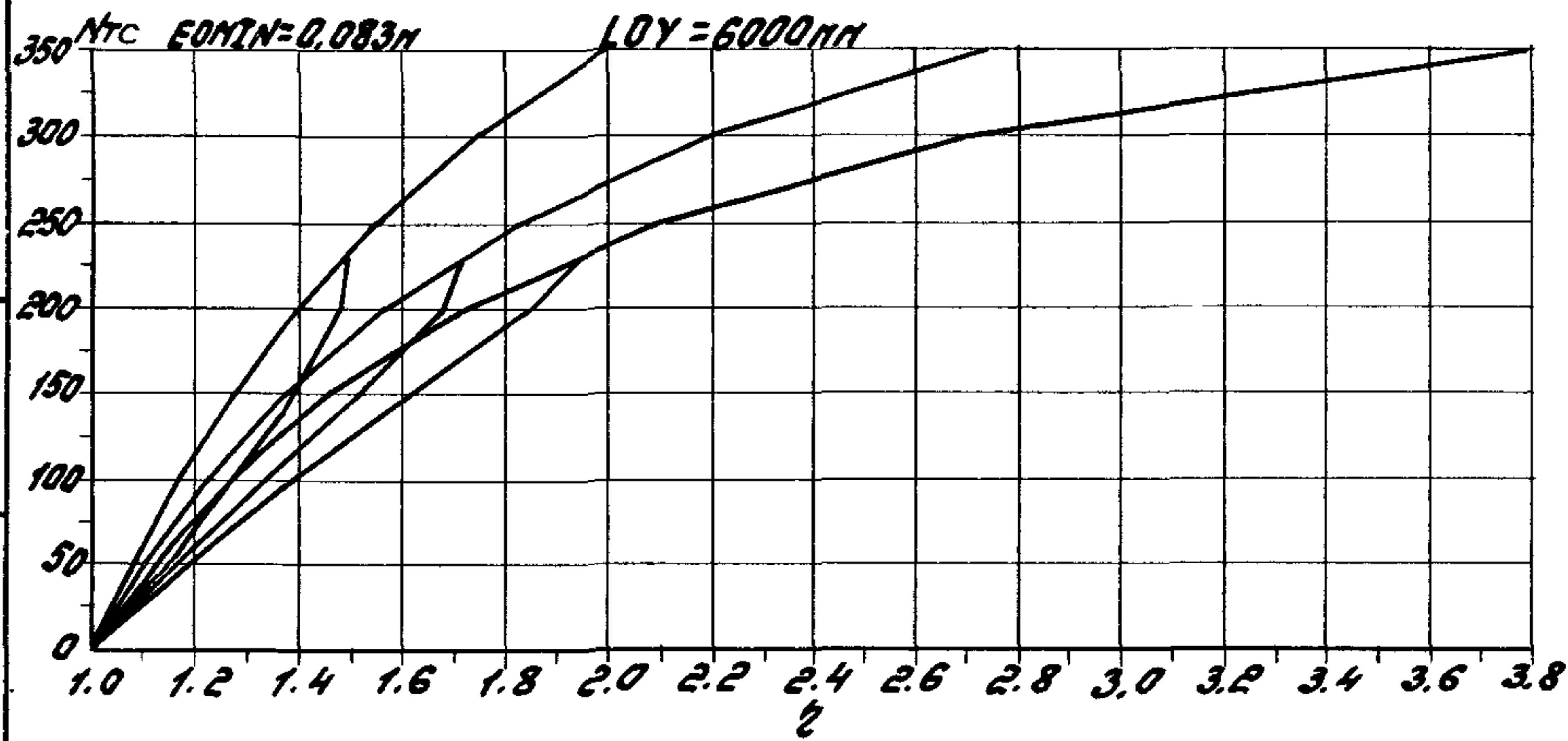
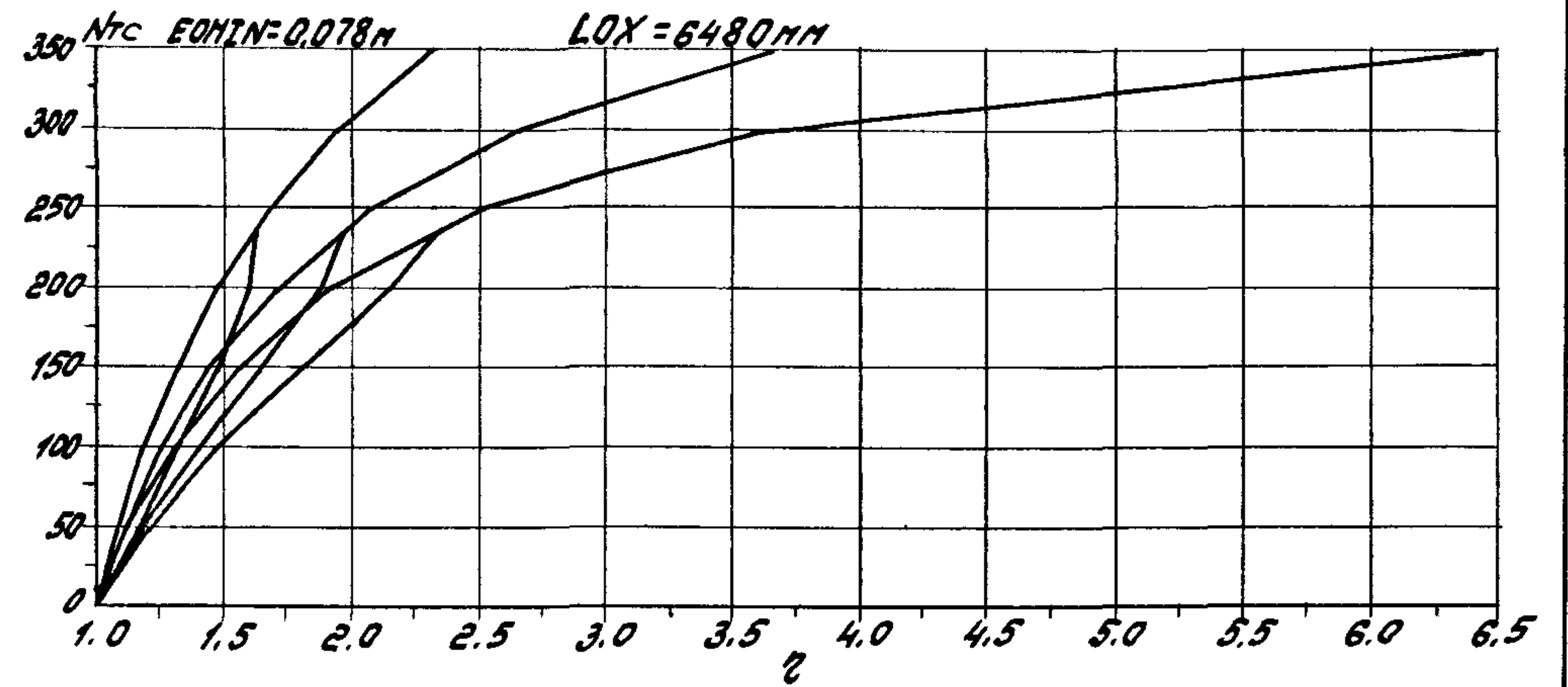
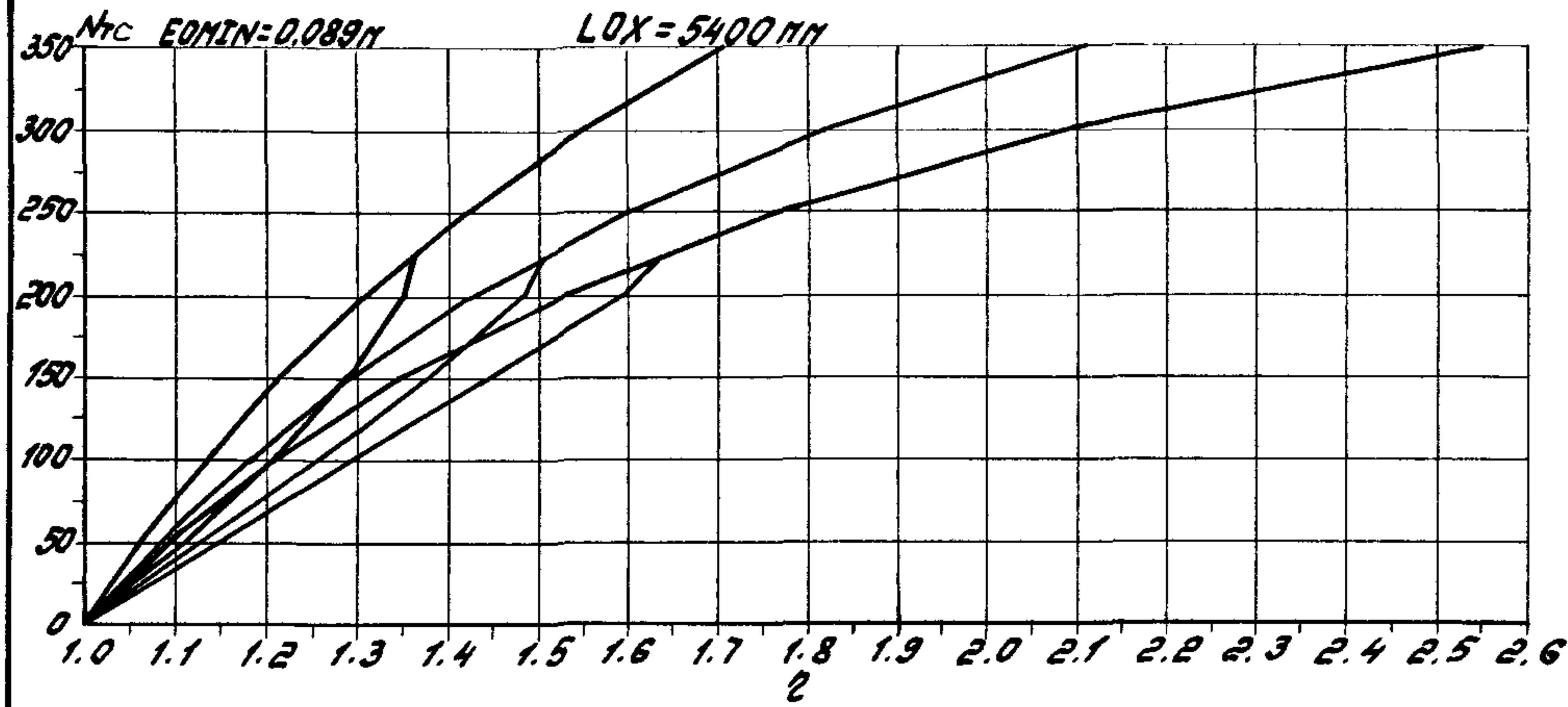

Учб. №: 10021. По адресу в Санкт-Петербурге. УИБ. А

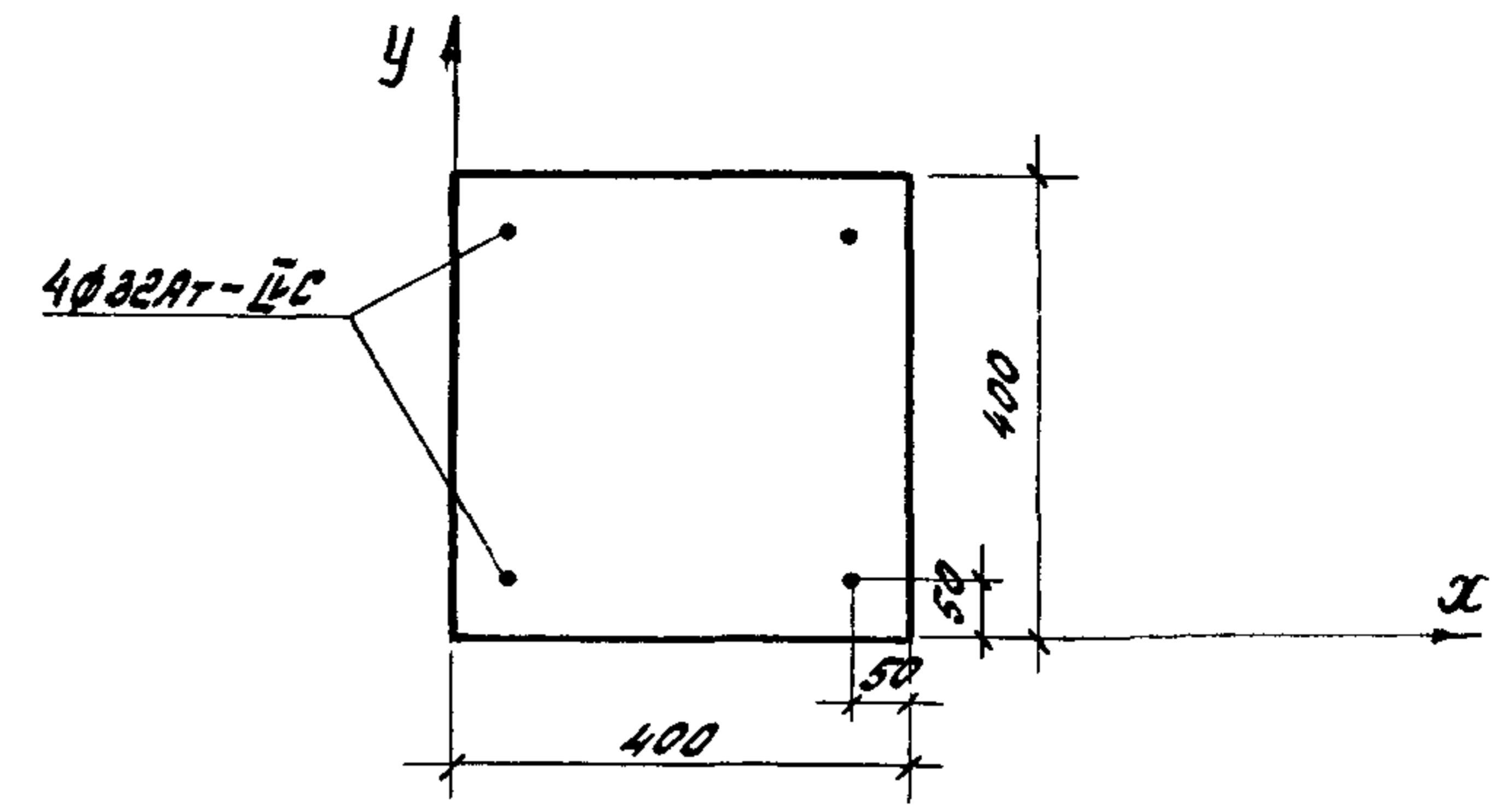
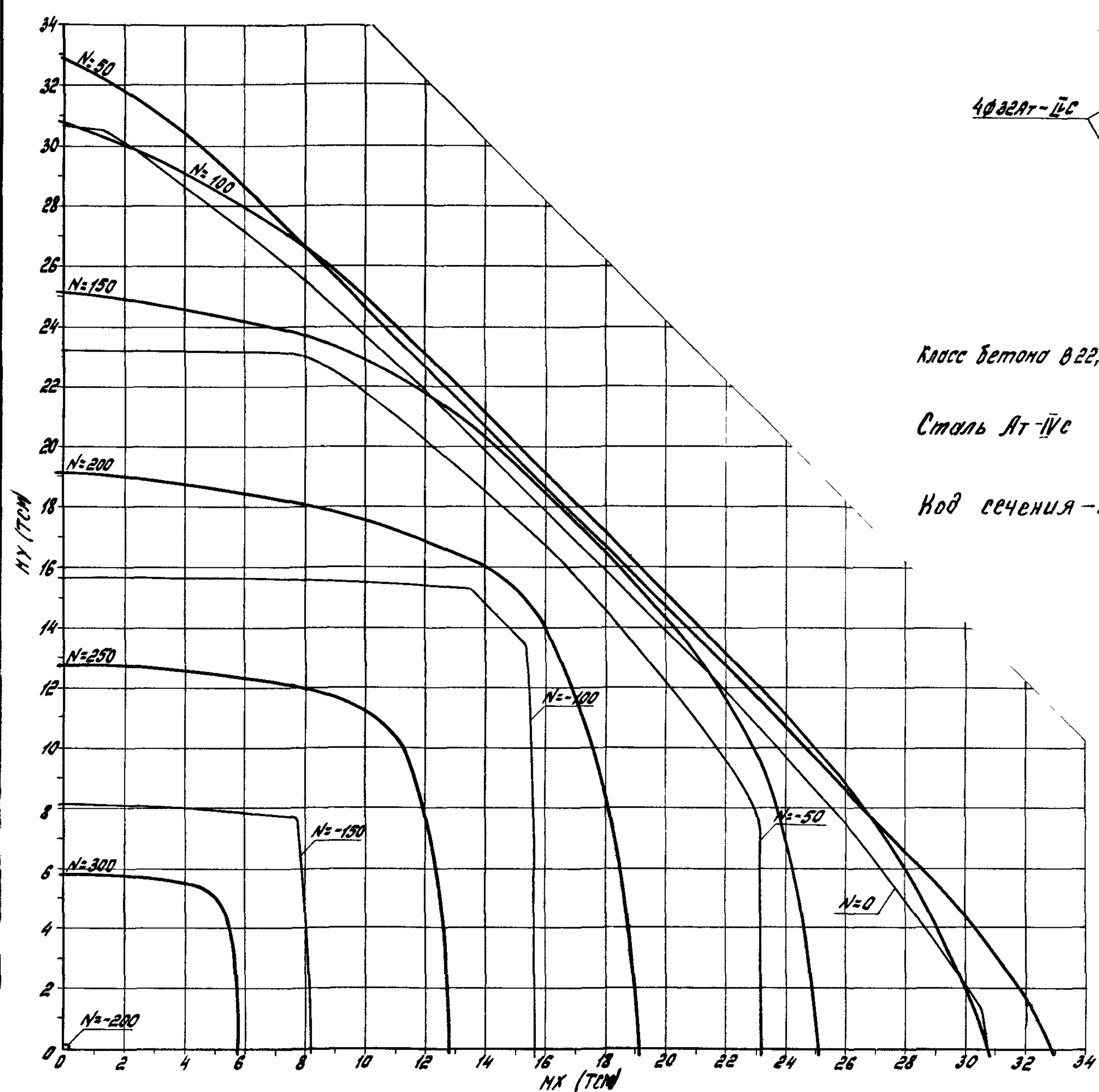

Класс бетона B22,5 ($R_b = 11$ МПа при учете $\gamma_{b2} = 0.90$)

Сталь АТ-IVc

Код сечения - 122δ

Инв. № подл. Подпись и дата Ввод. №

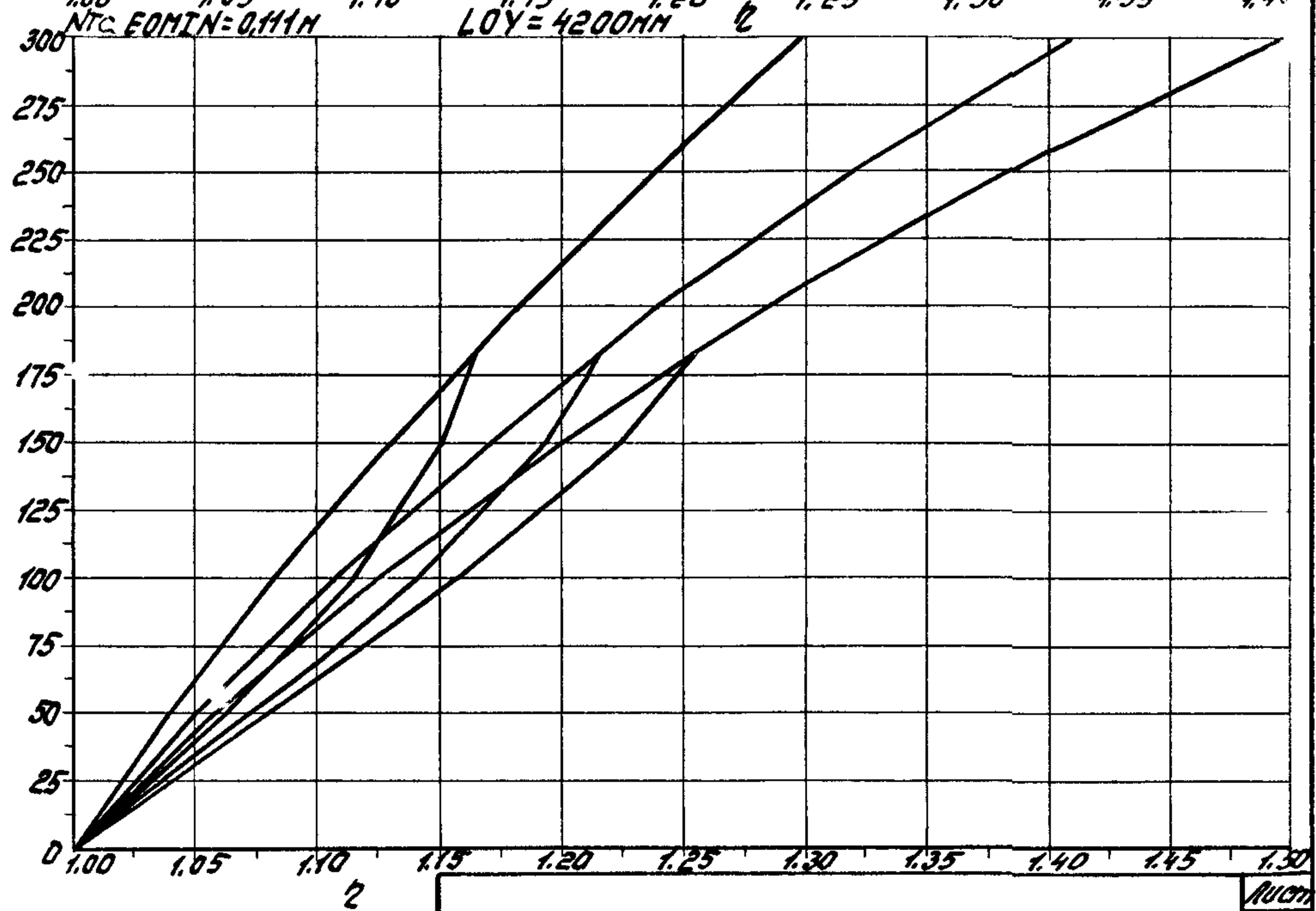
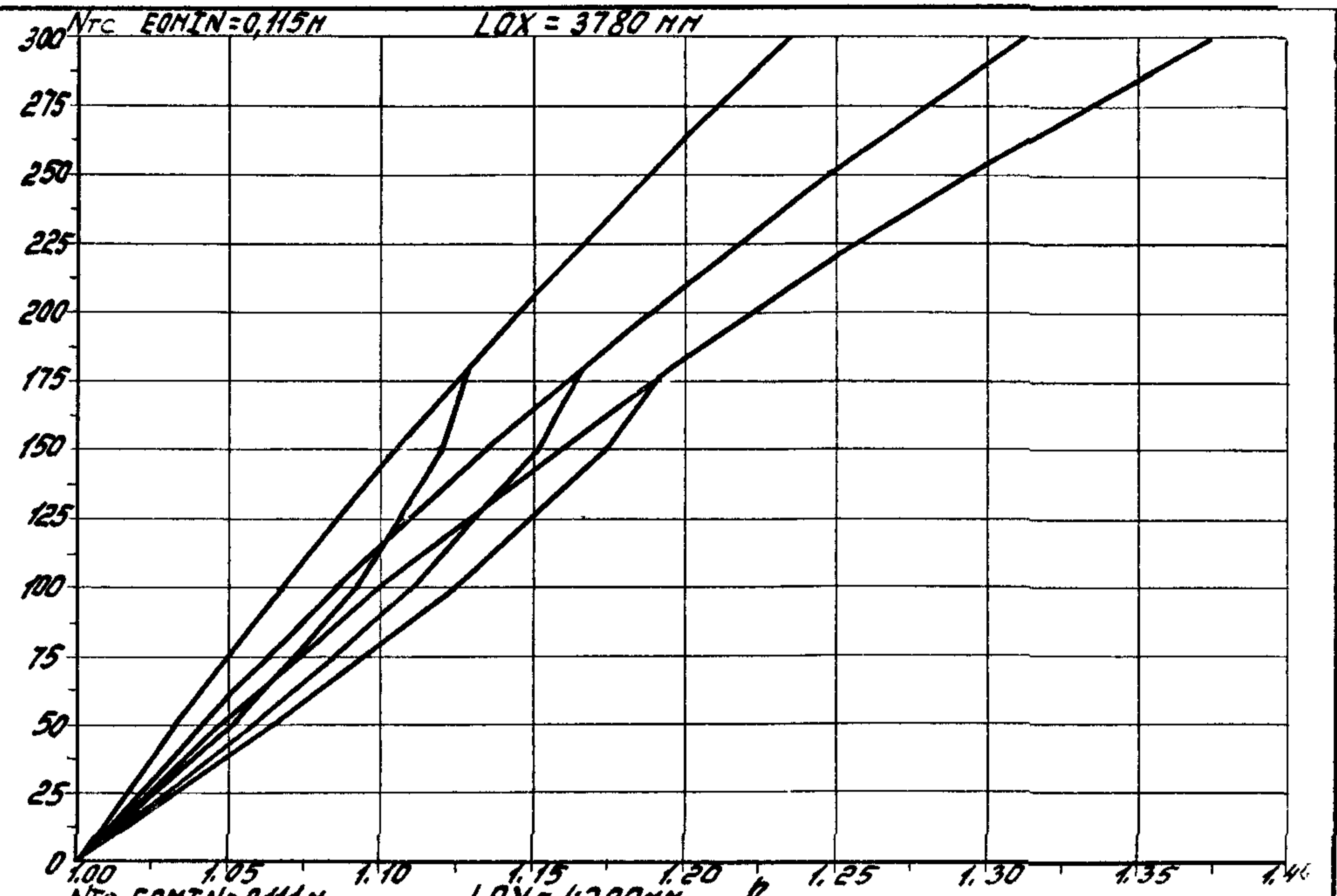
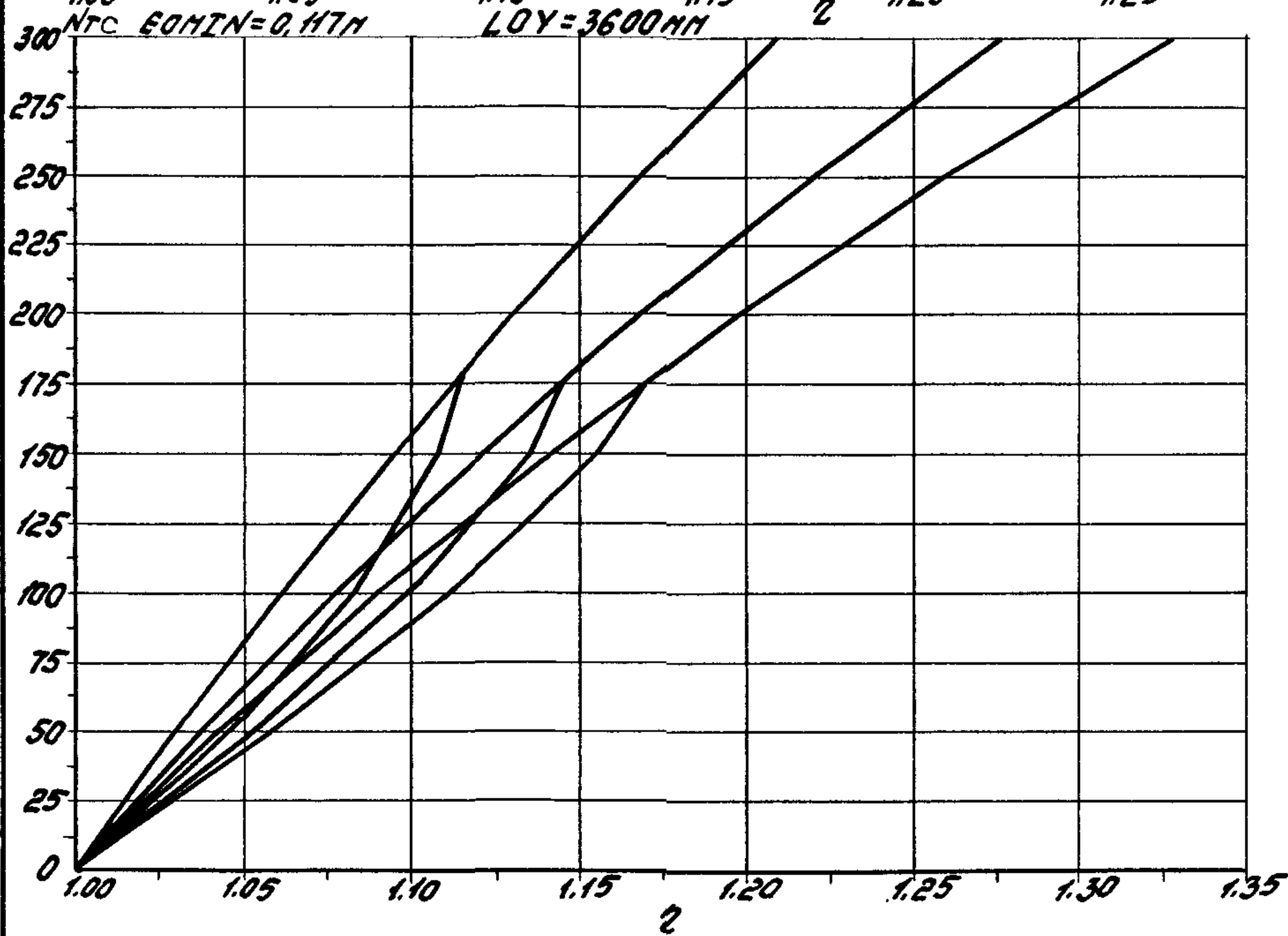
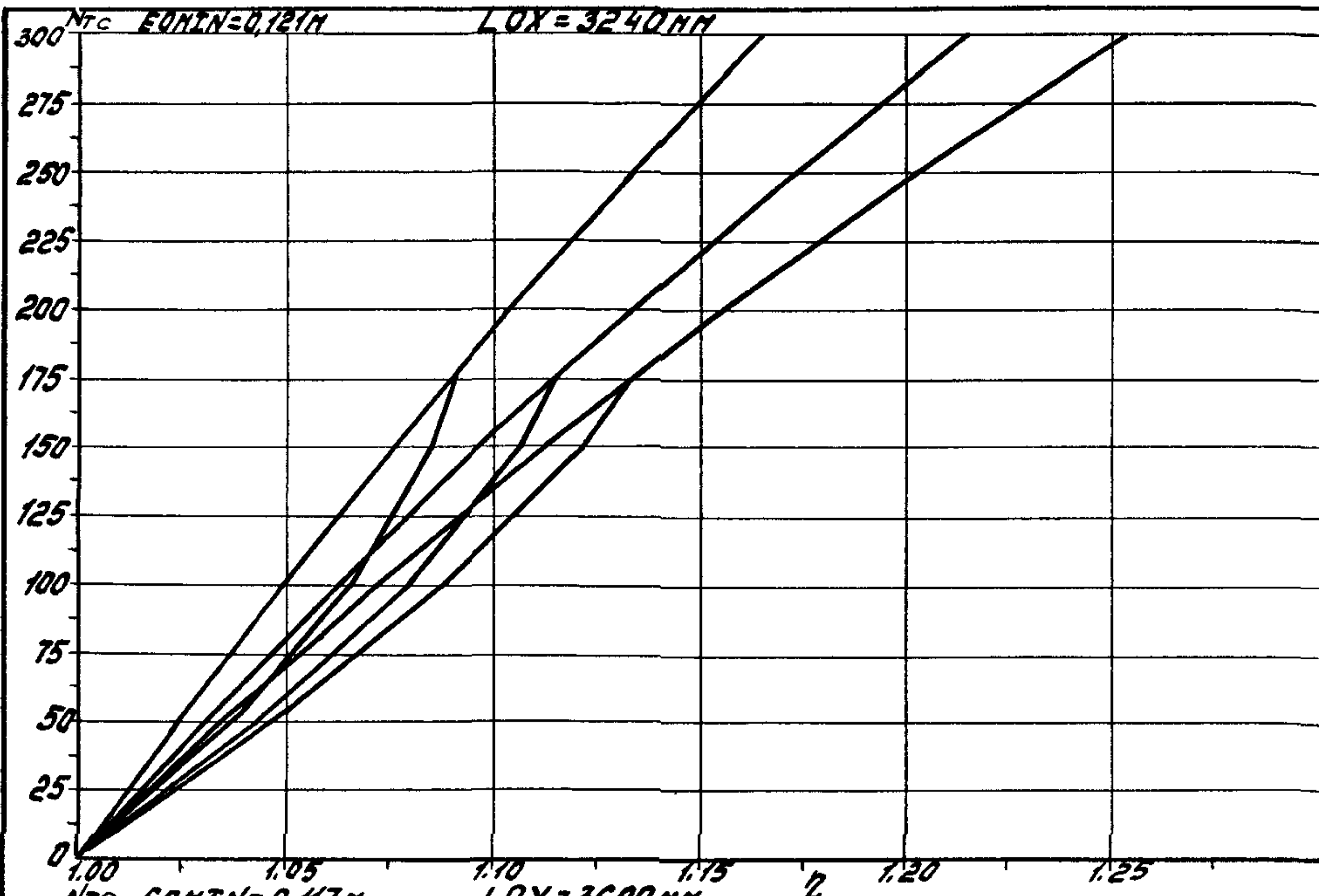

1.020.1-4 0-9 002

174

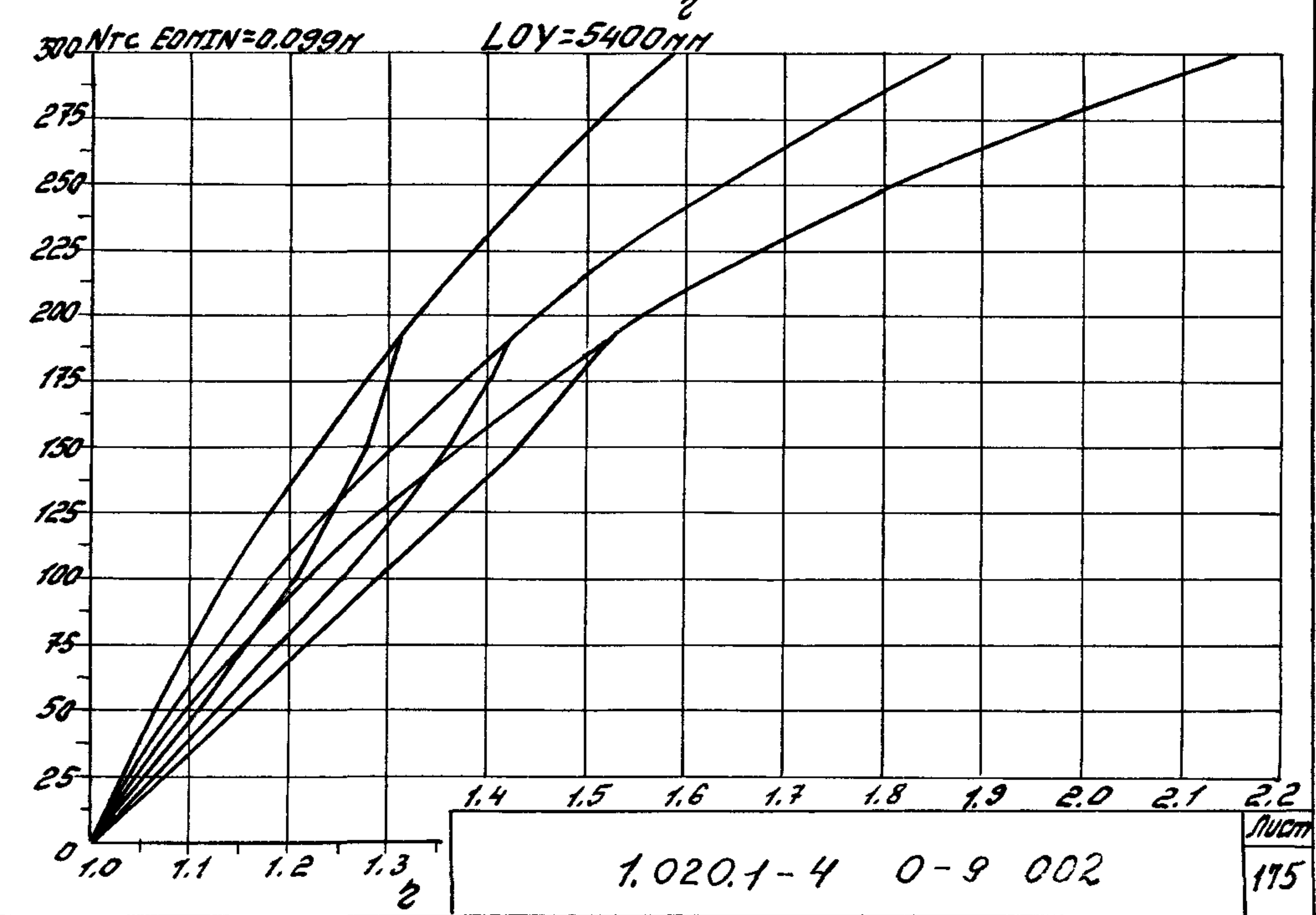
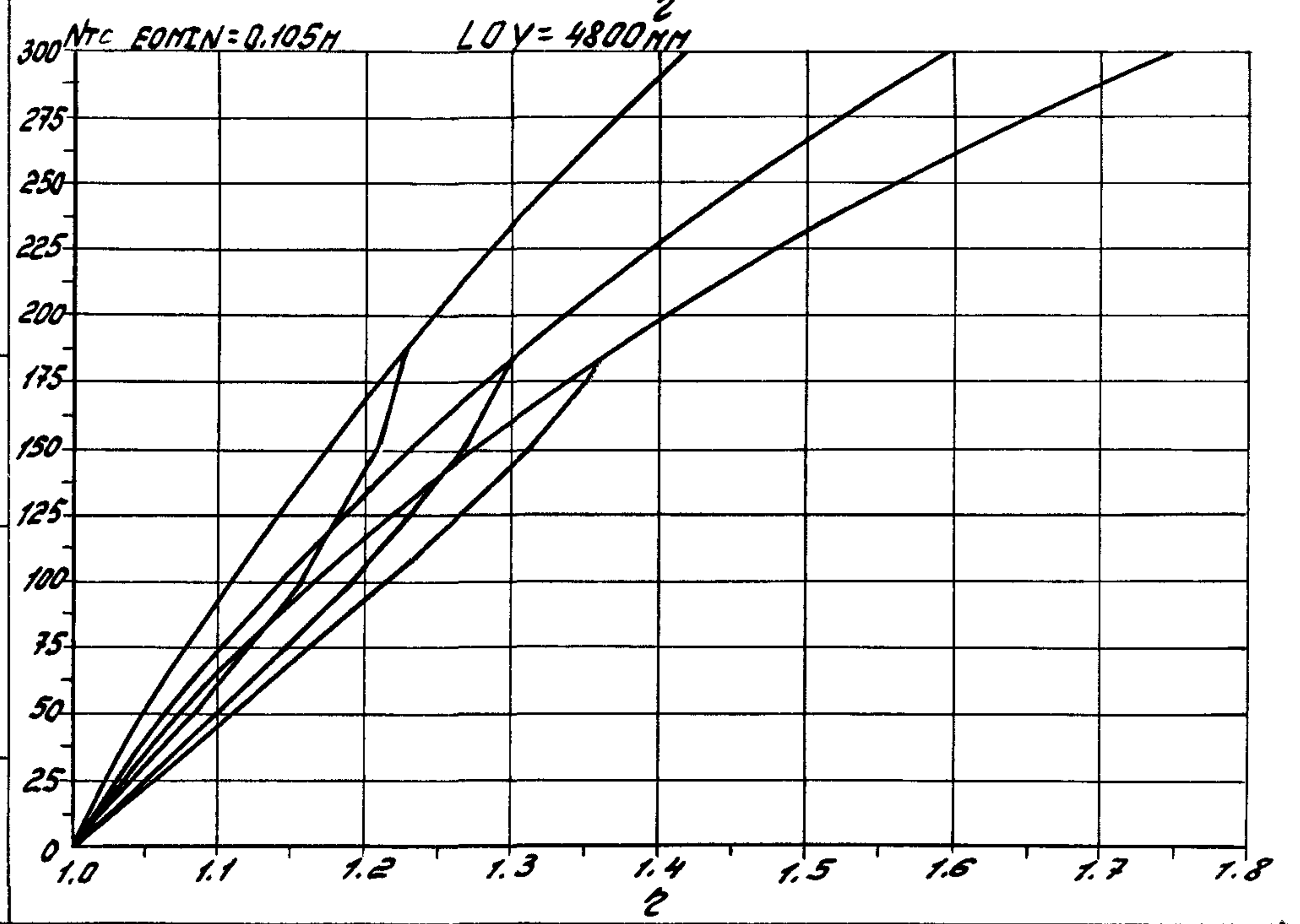
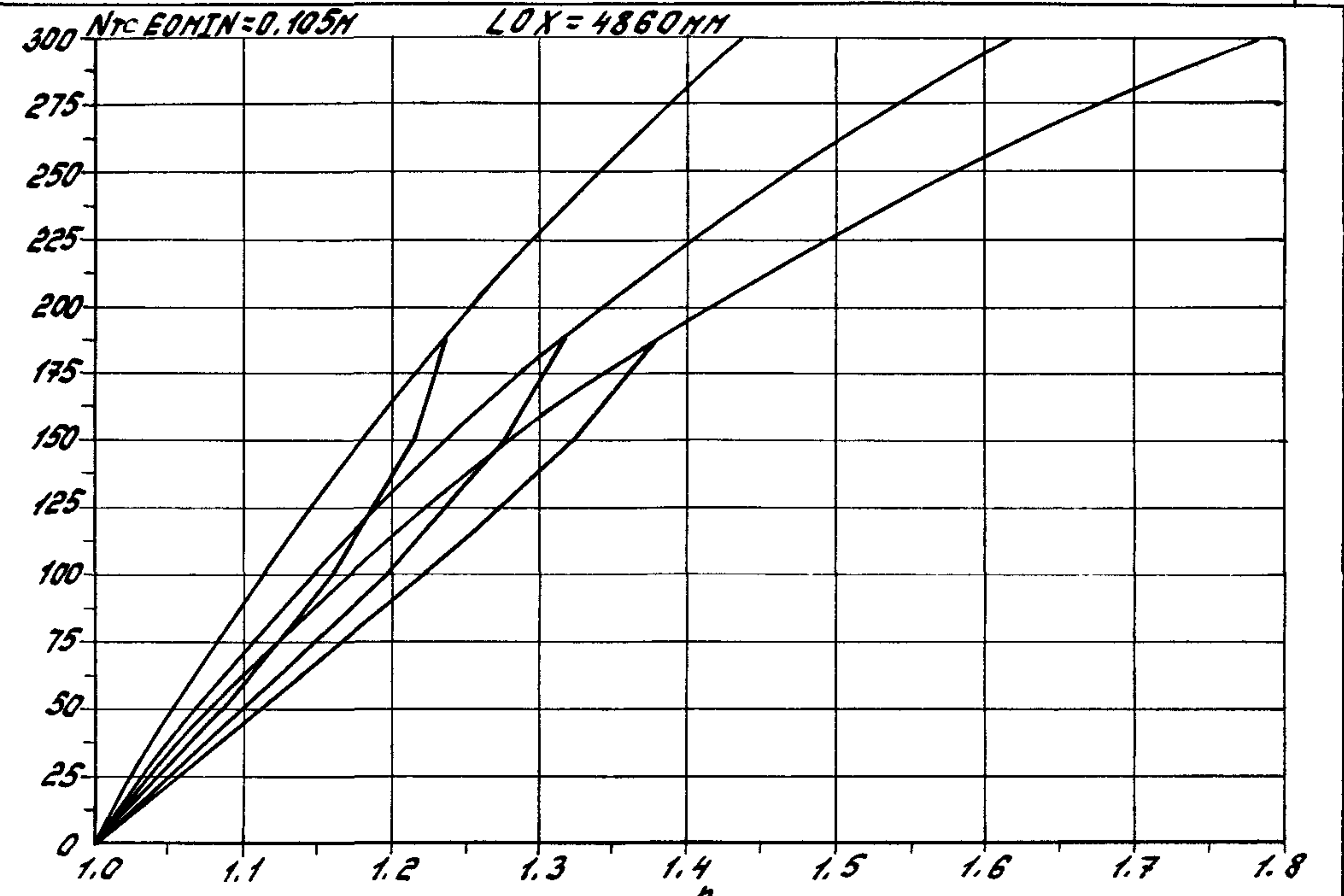
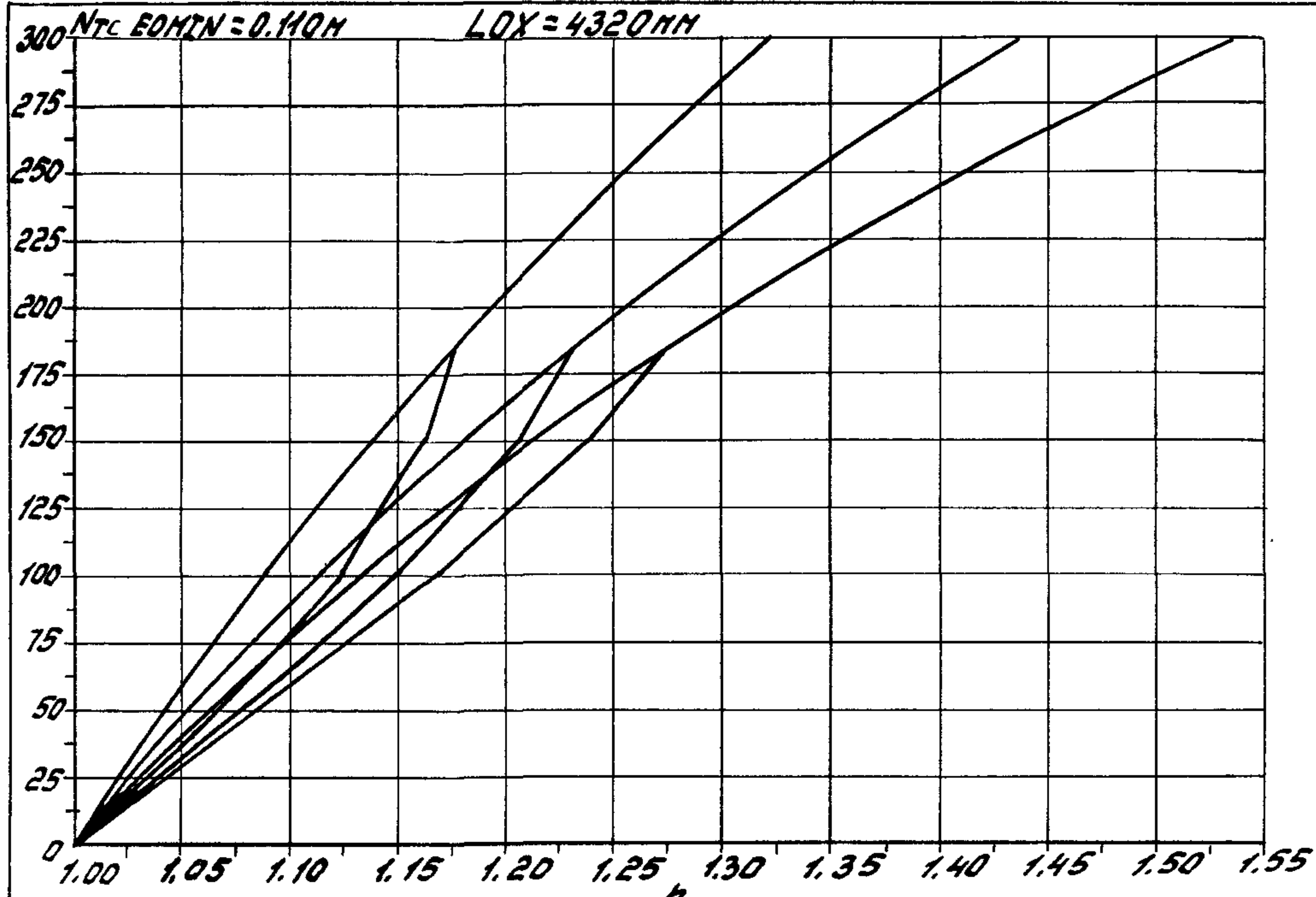

Упр. № 1000. Умнож. 6 0011010. М. И. М. 6. М.

1.020.1-4 0-9 002

175

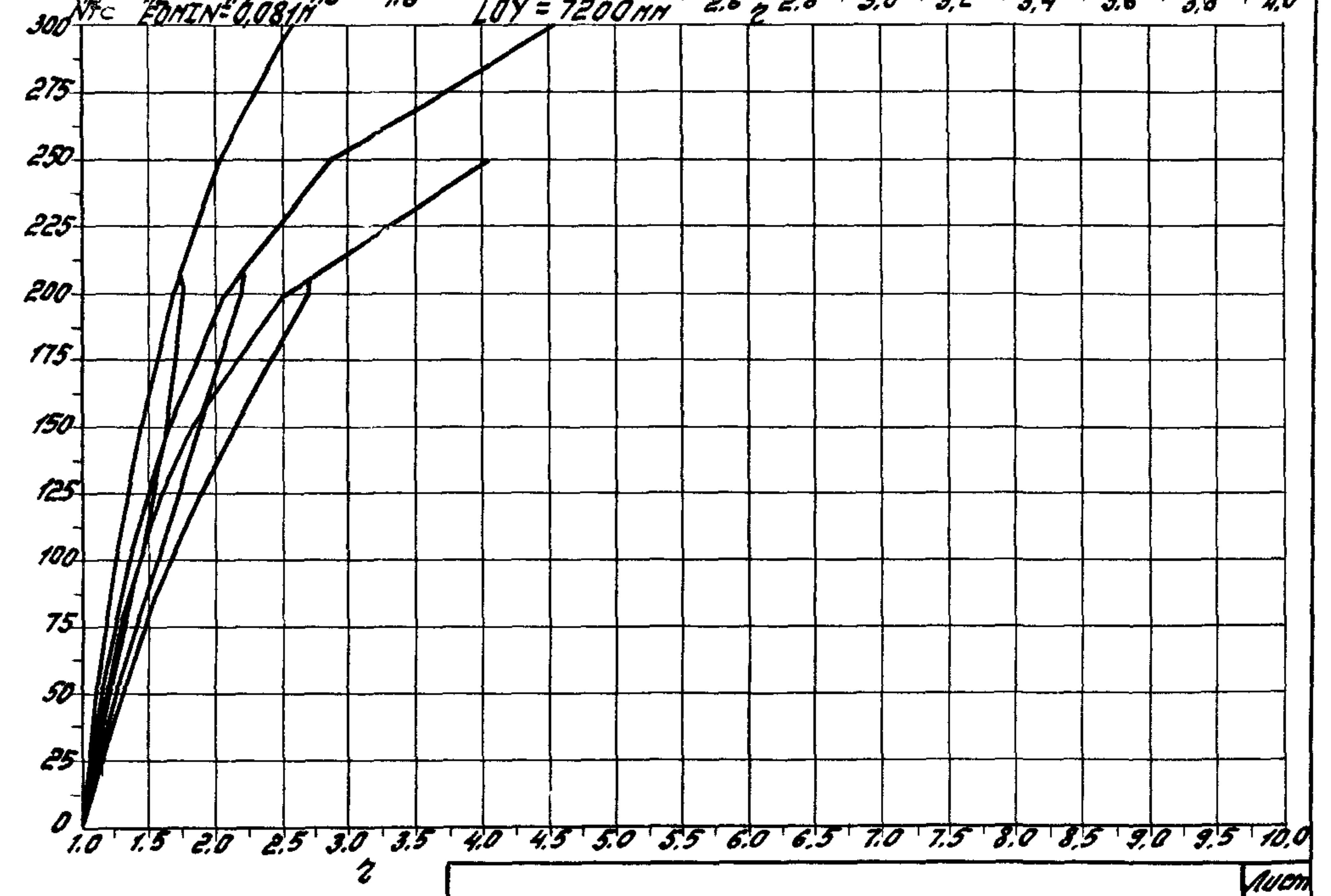
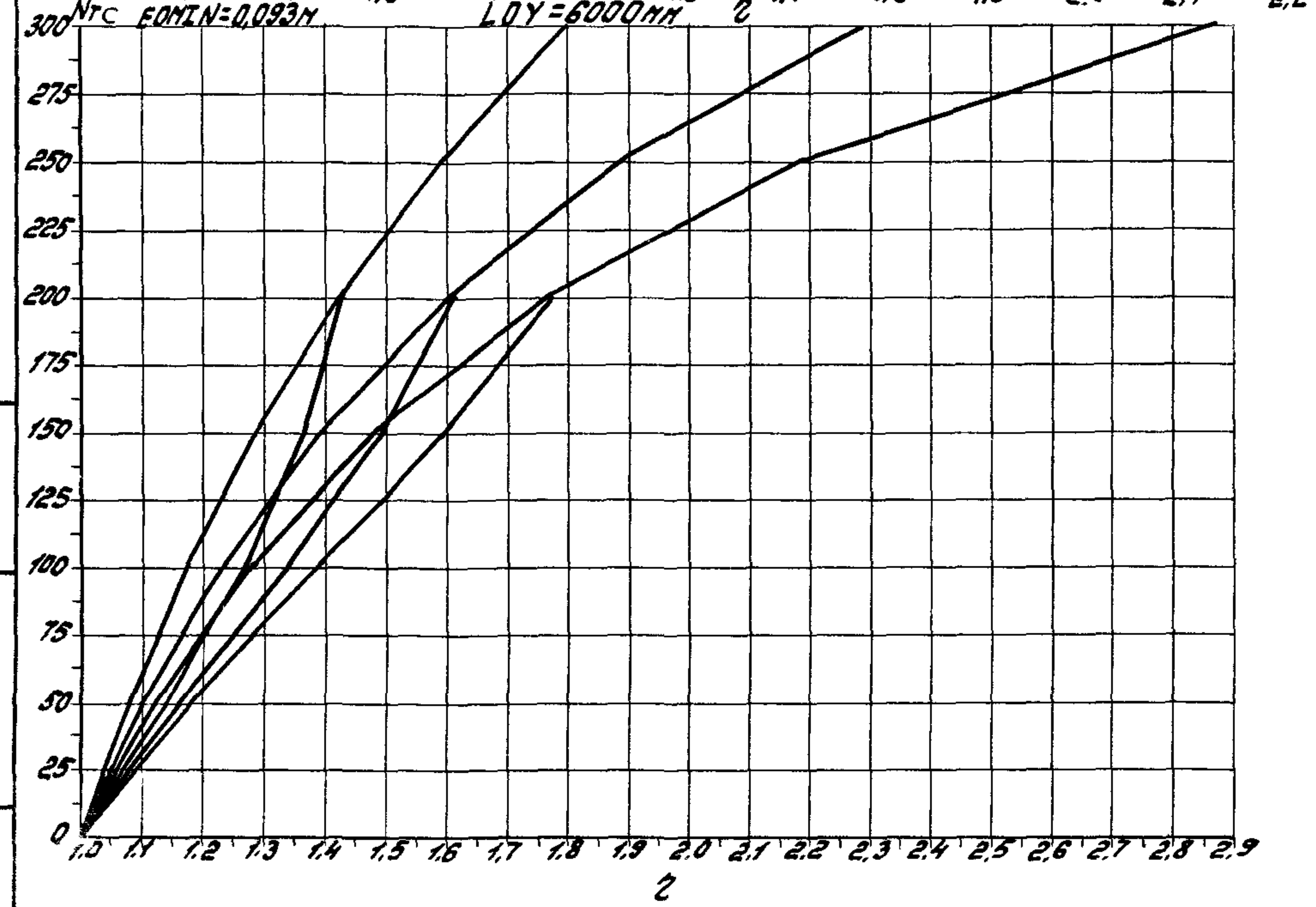
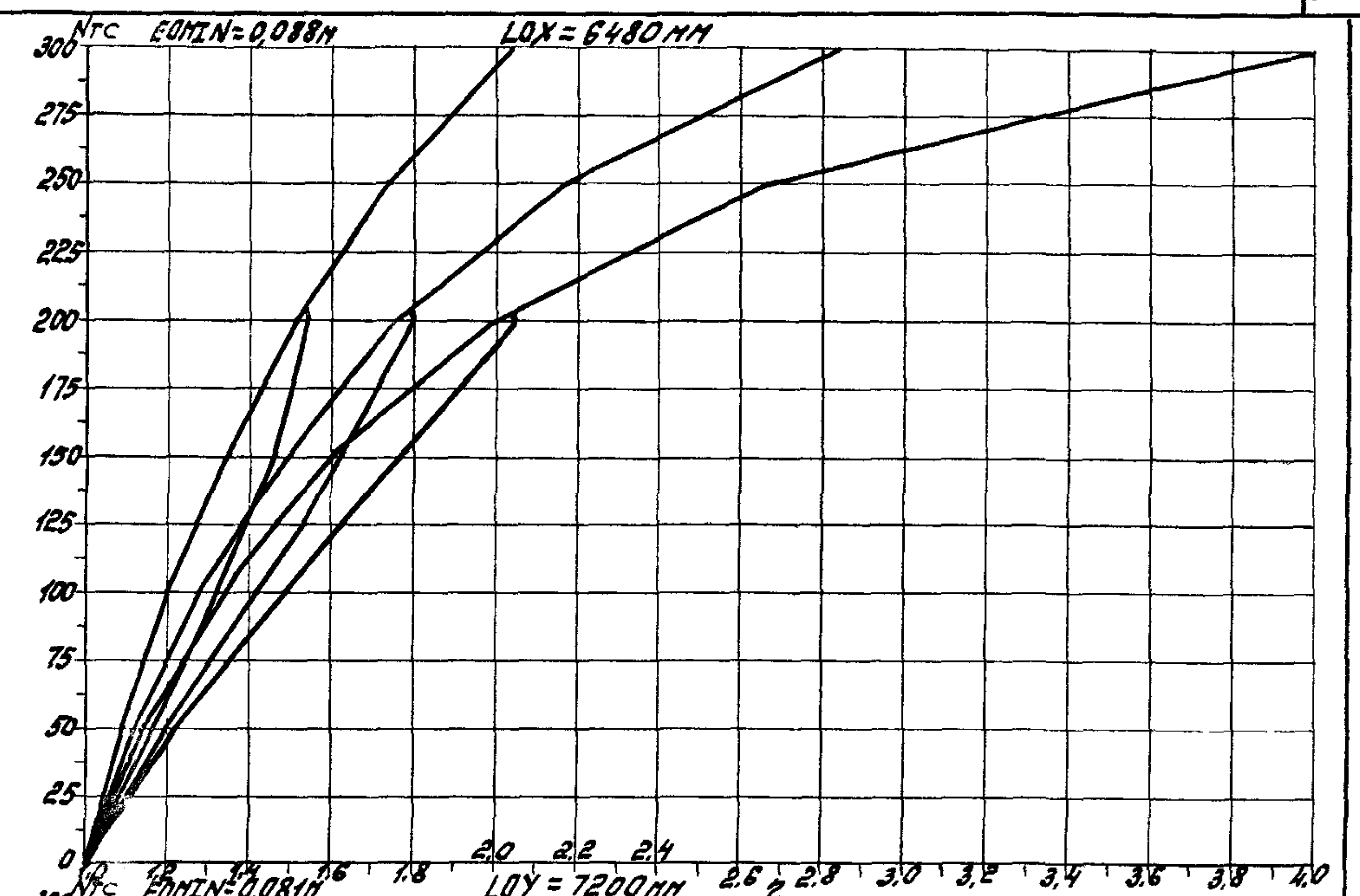
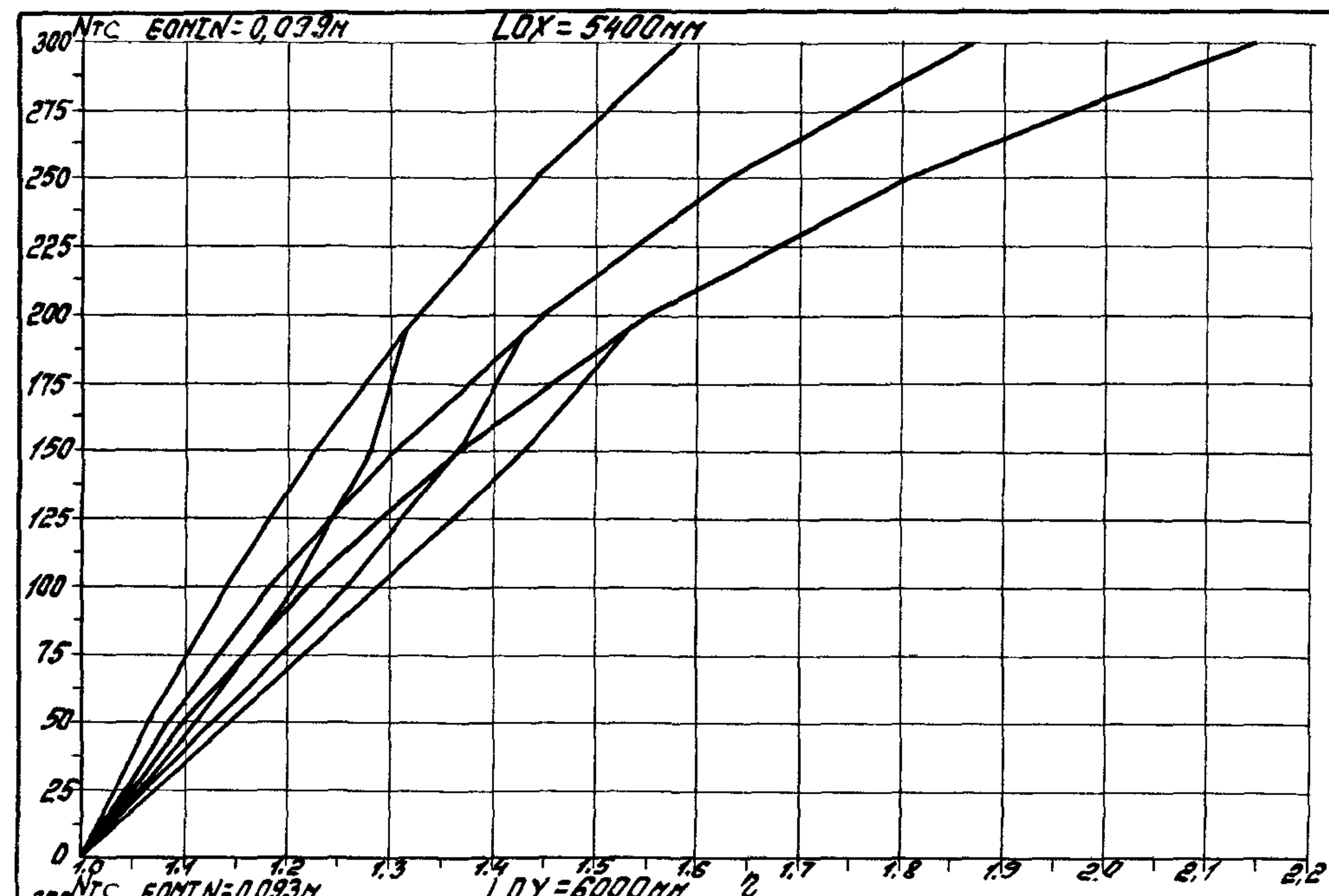

Шиб. и подл. Подпись и дата Взам. инв. №

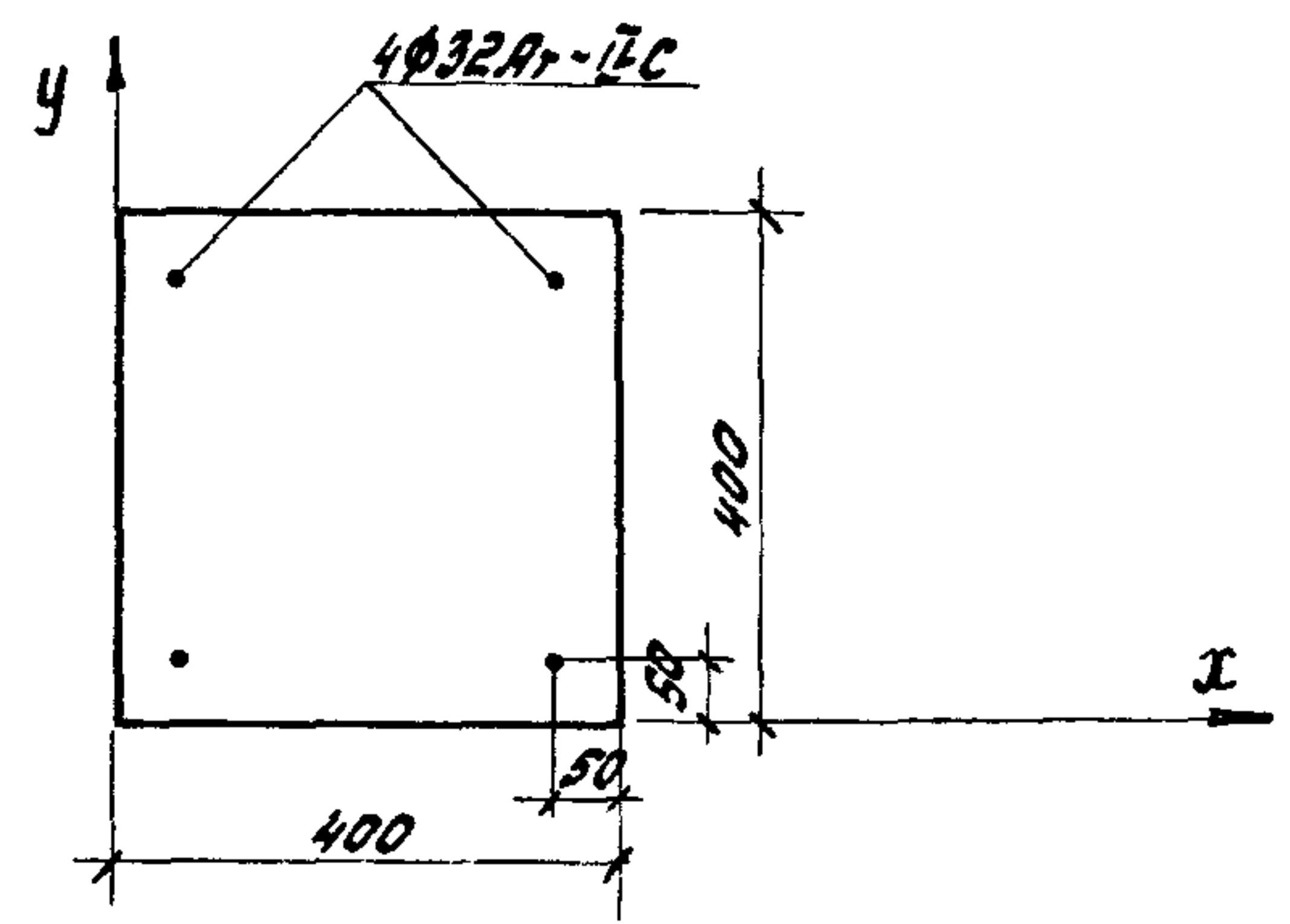
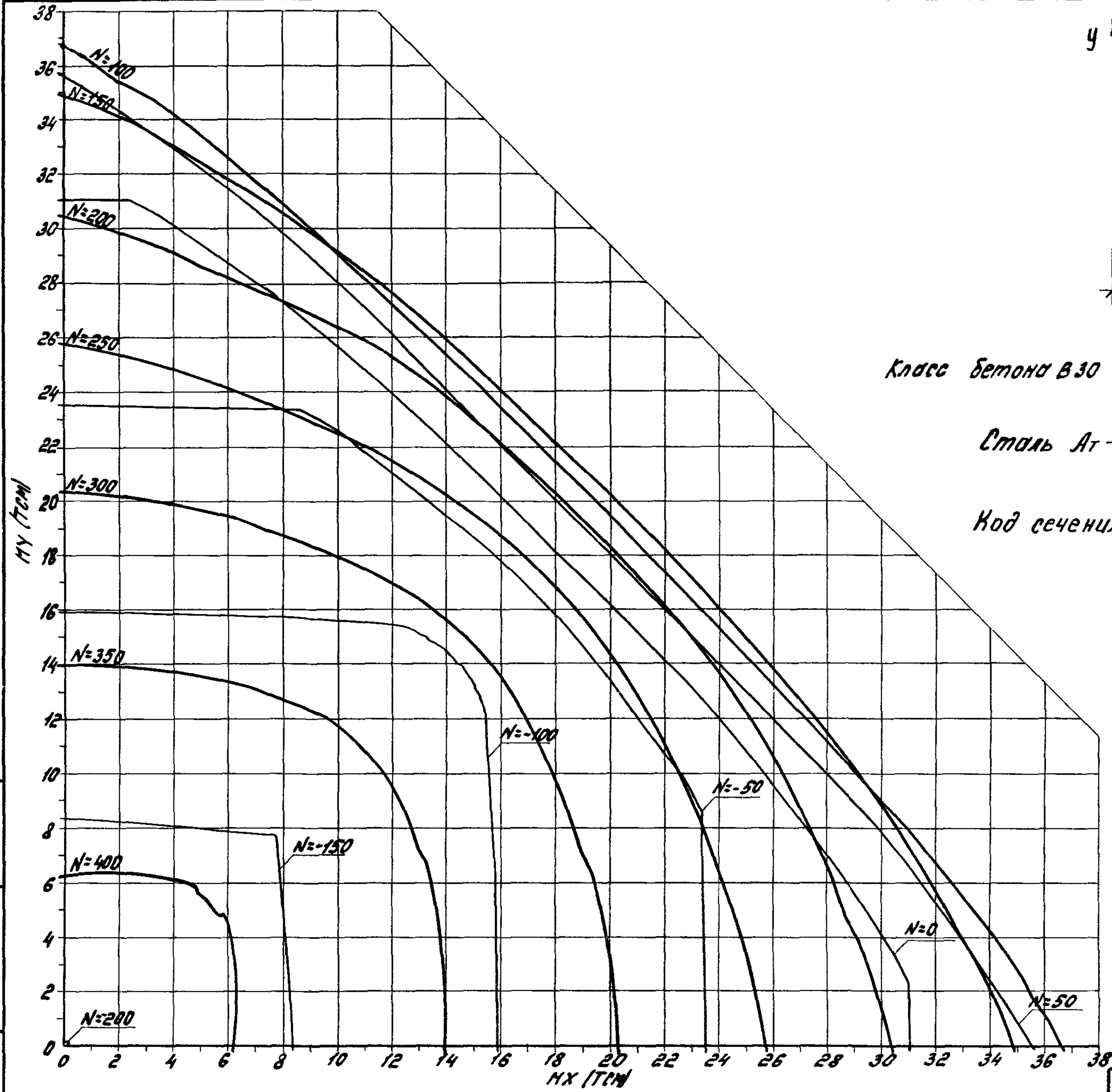

Класс бетона В30 ($R_b = 18.7 \text{ МПа}$ при учёте $\gamma_{b2} = 1.10$)

Сталь Ат-IVс

Код сечения - 123а

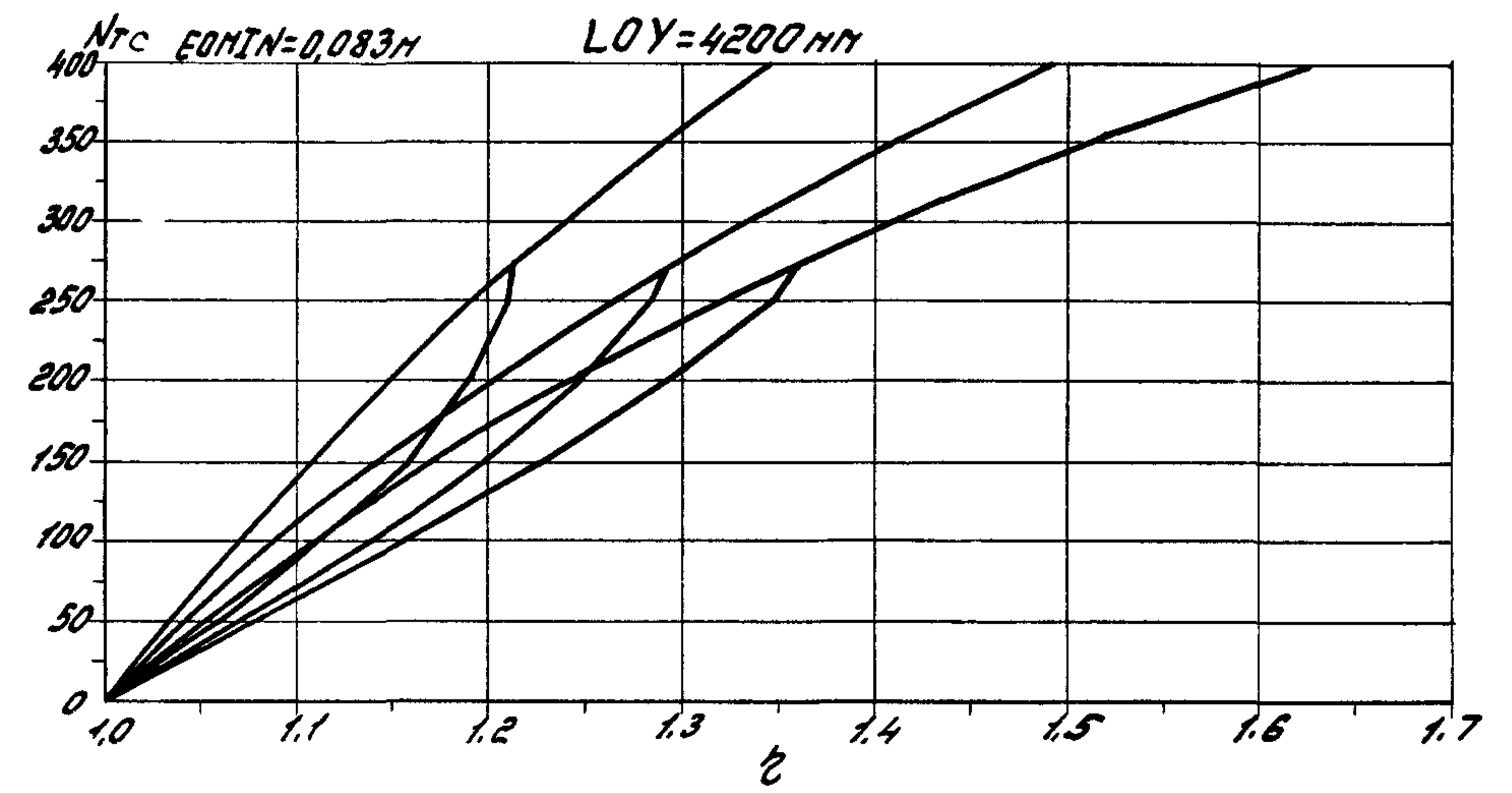
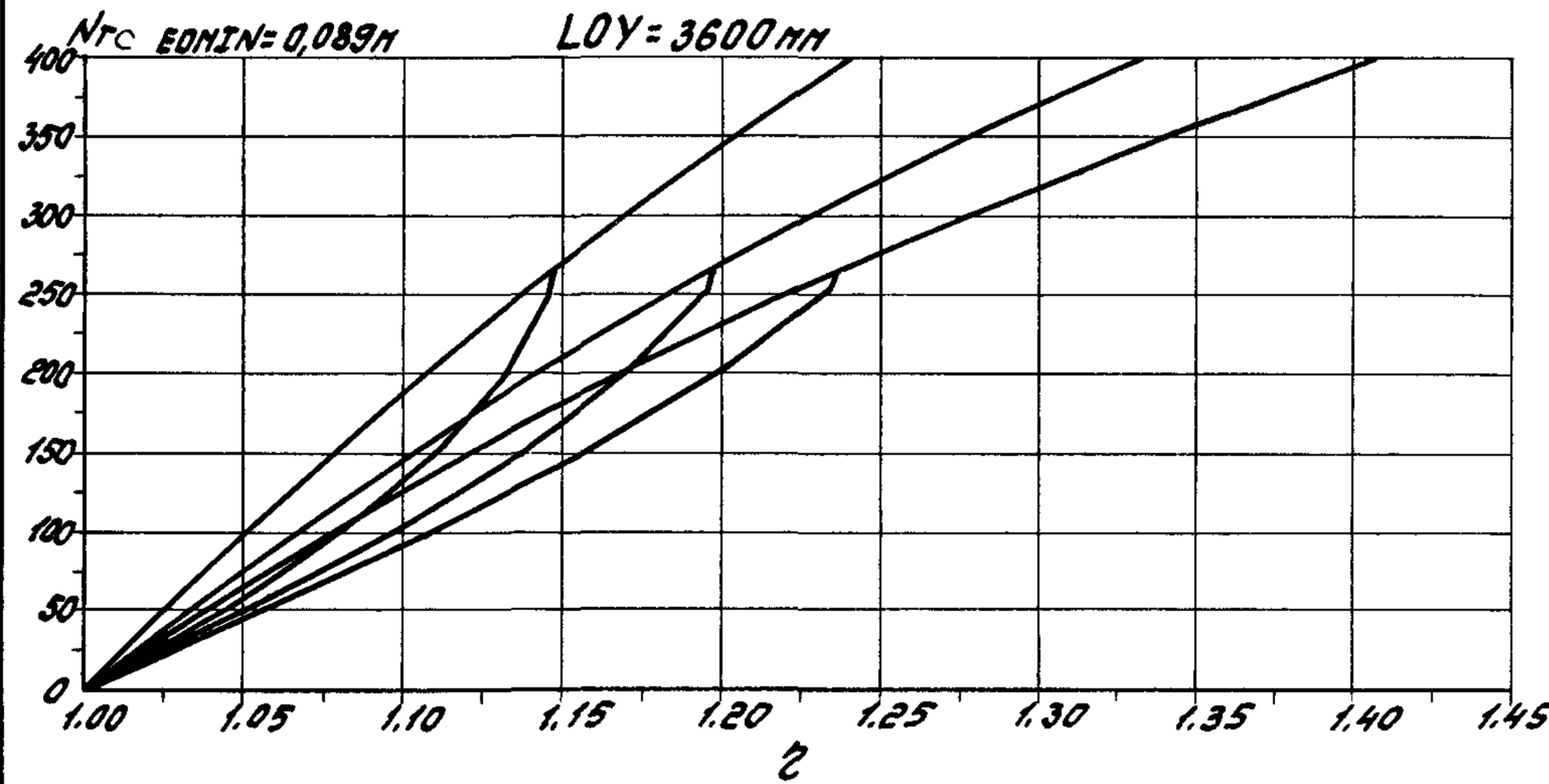
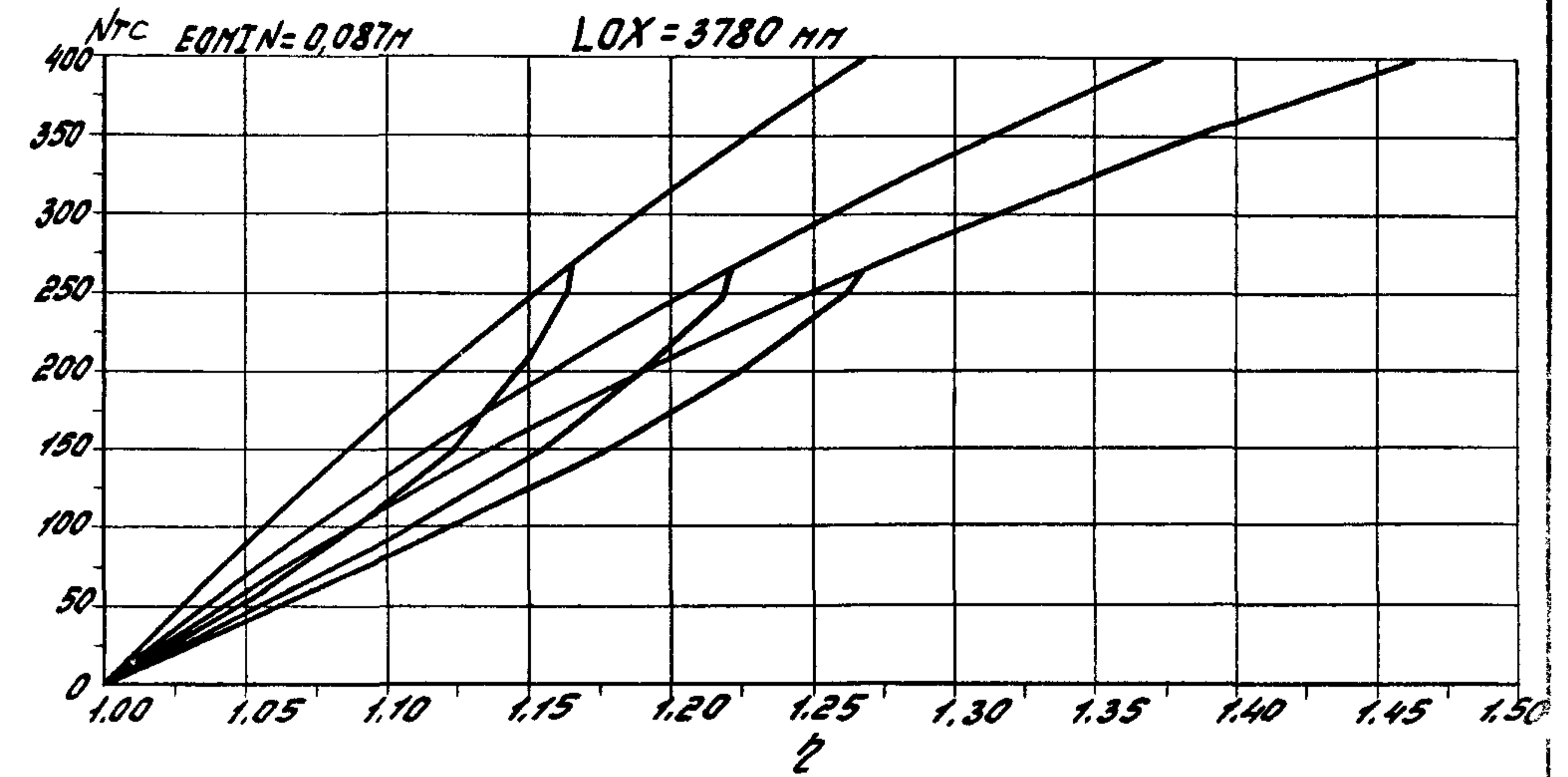
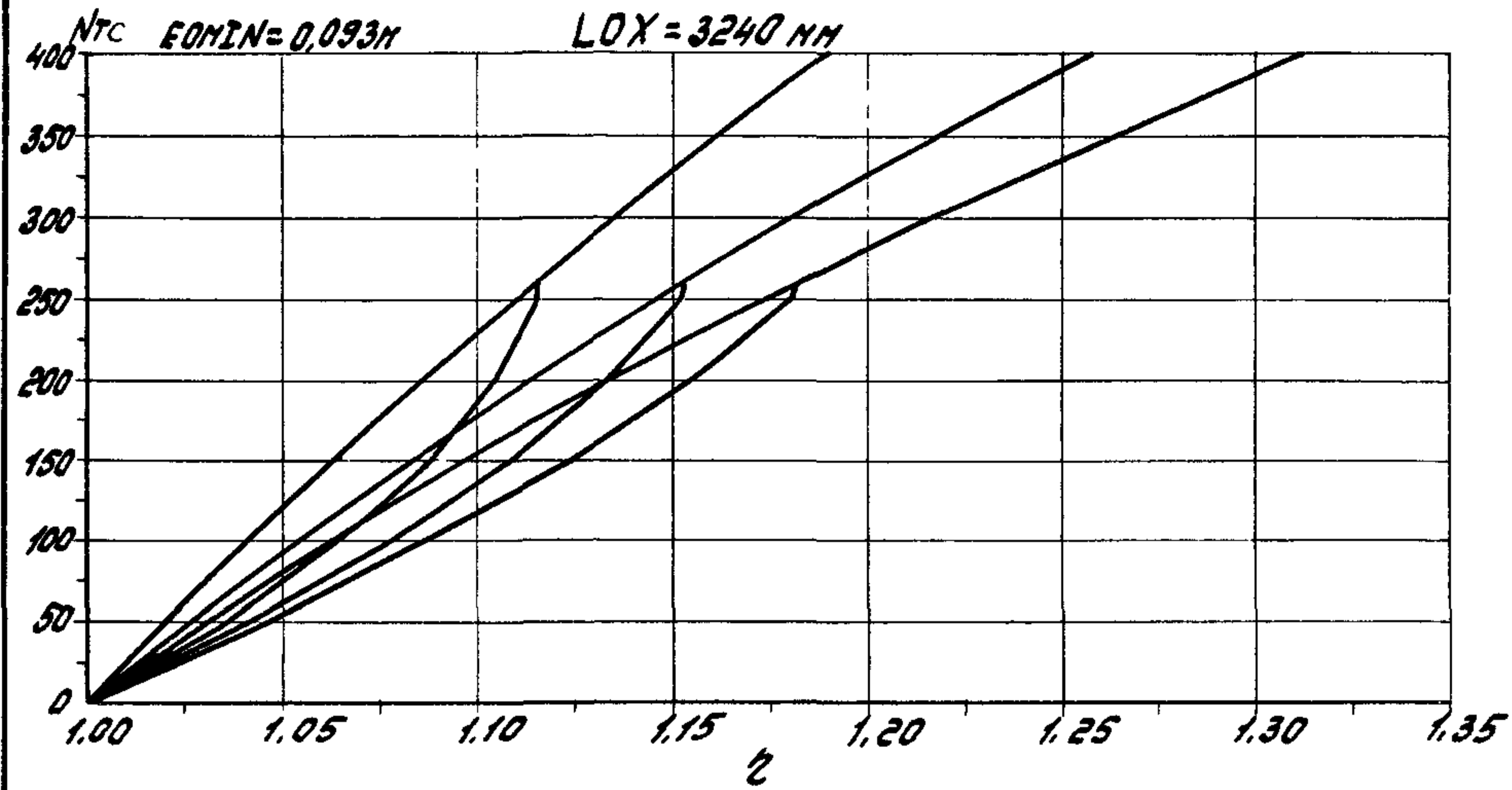

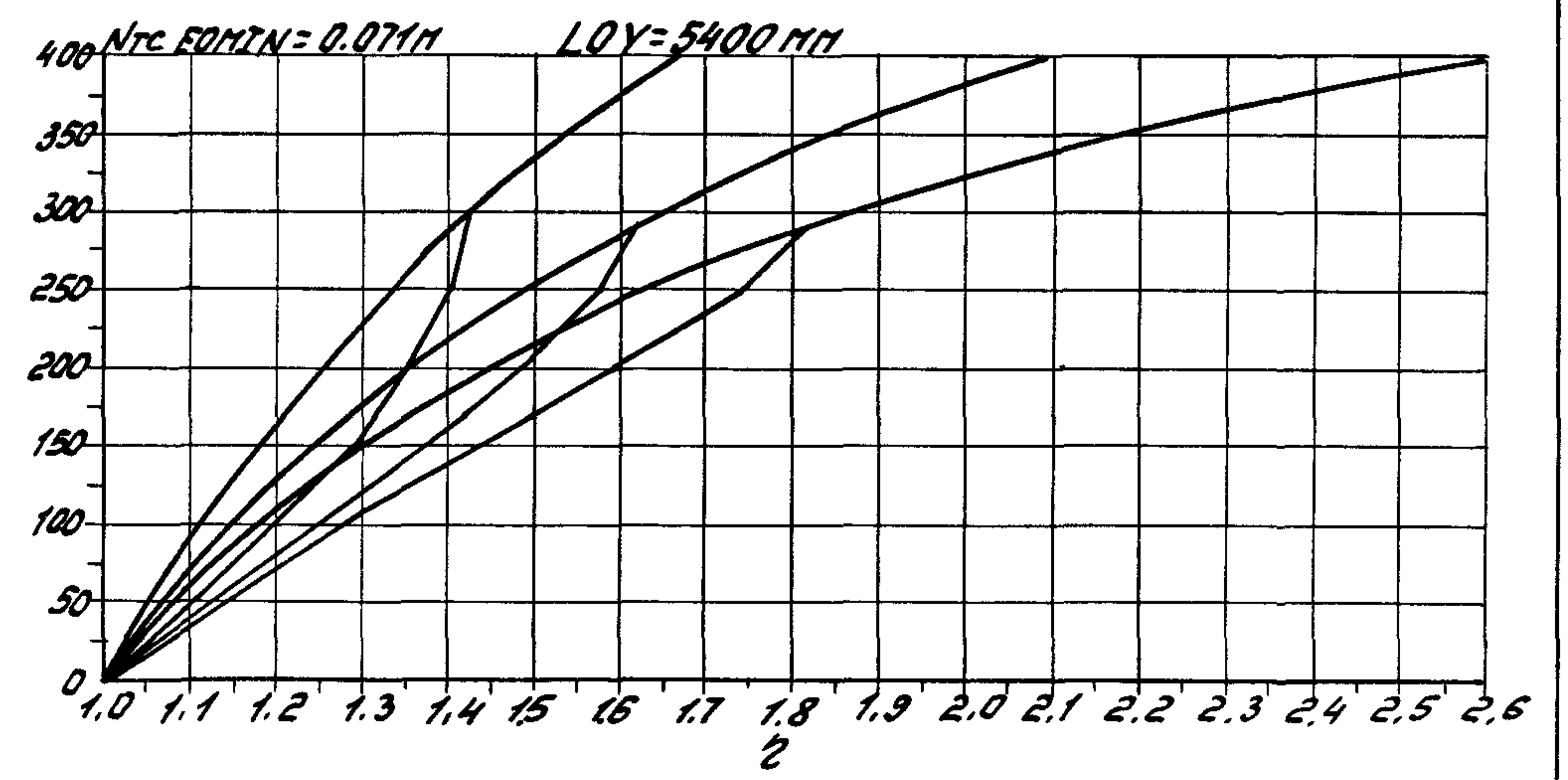
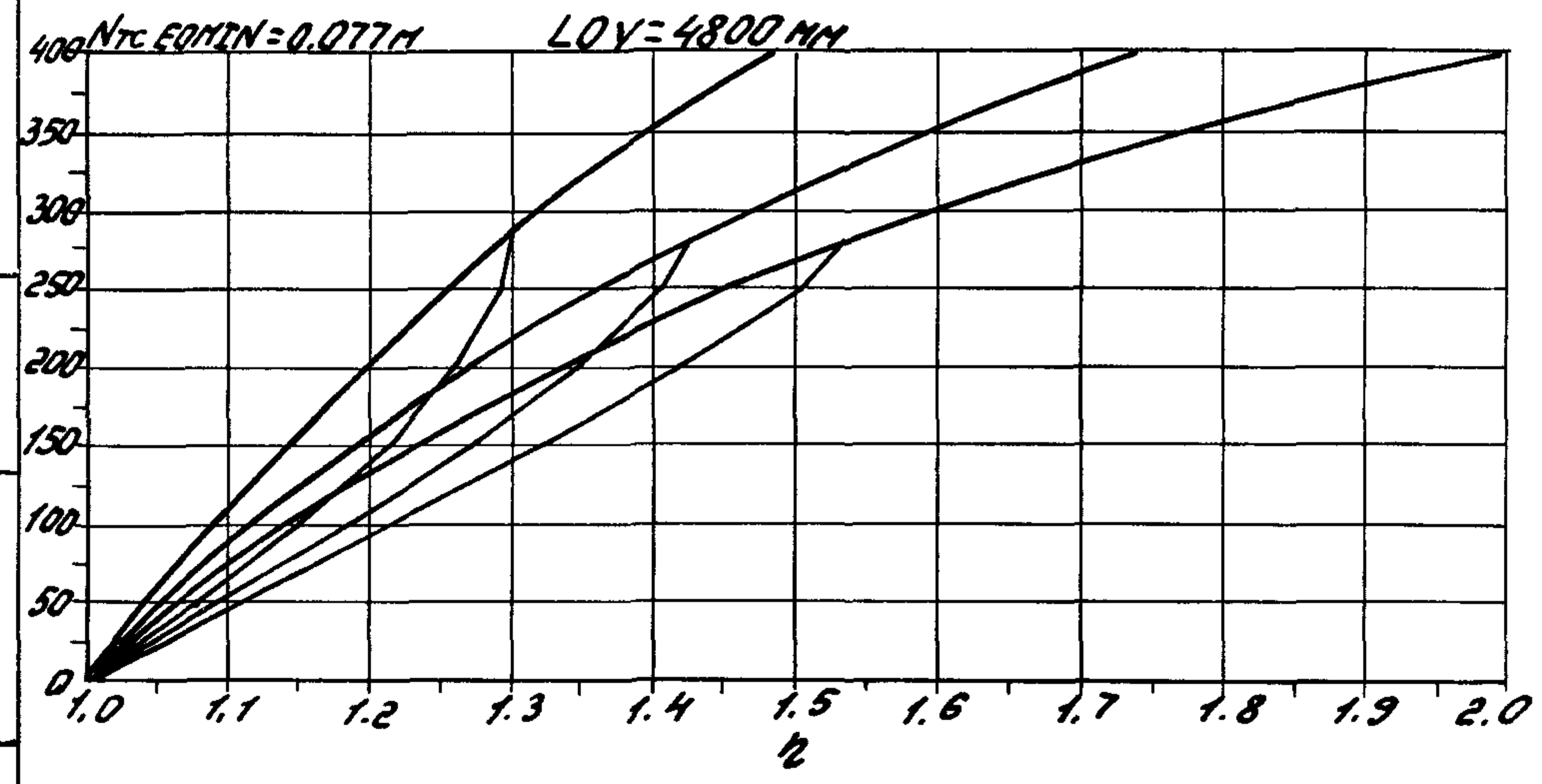
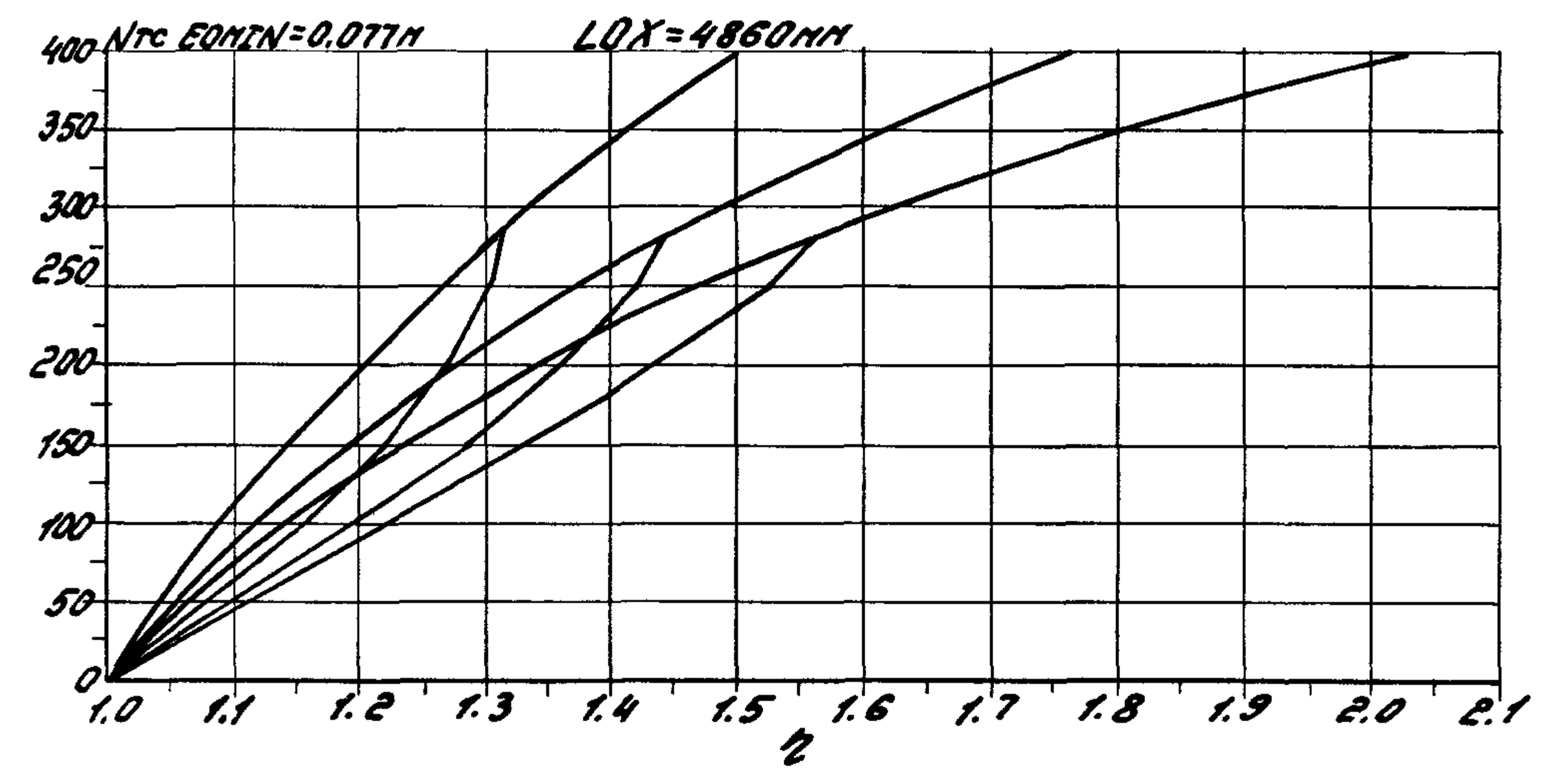
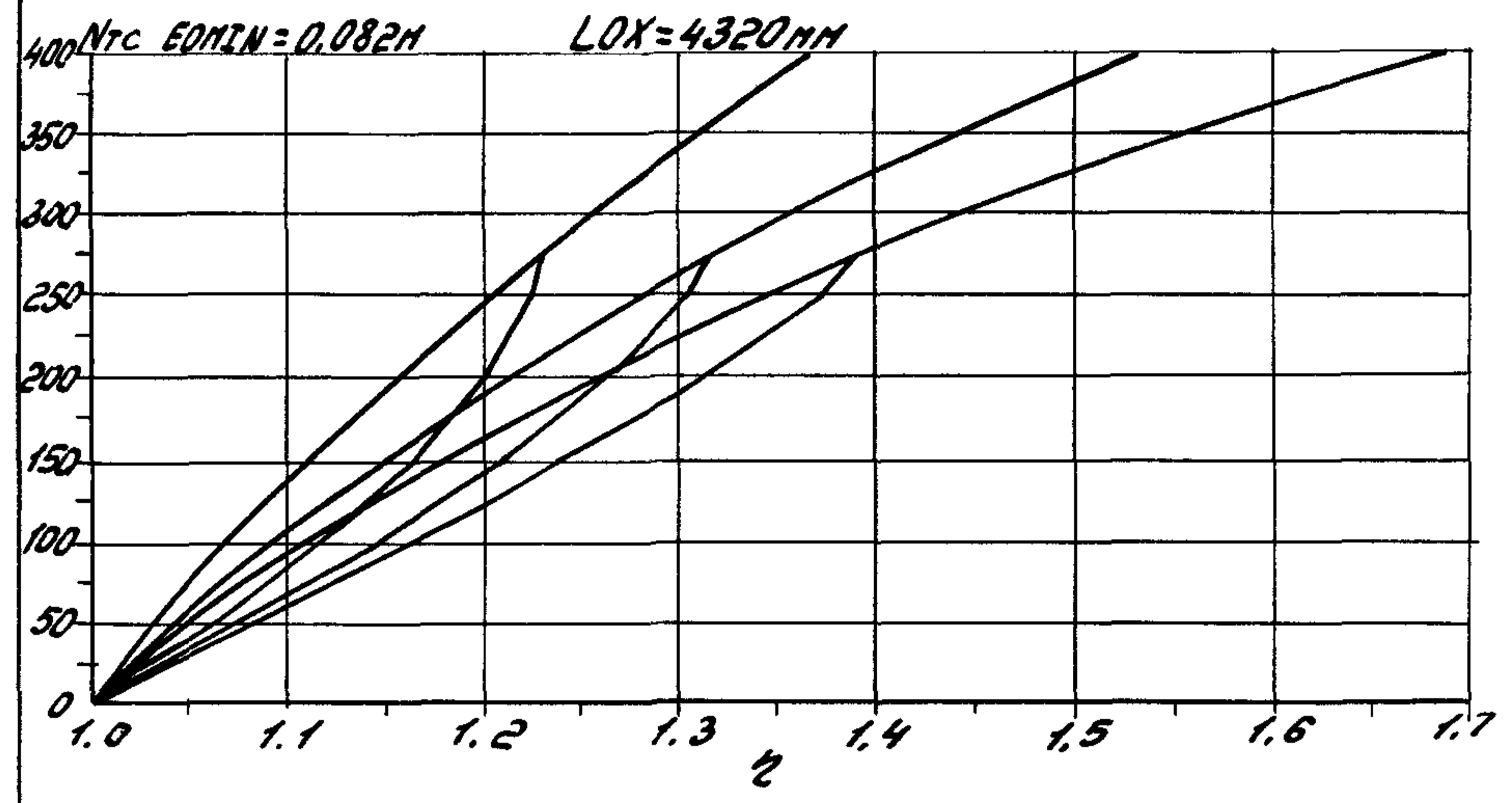

Шиф. проекта. Погруппы и дата. ВЗЛП. ИМБМ

1.020.1-4 0-9 002 ИМБМ
179

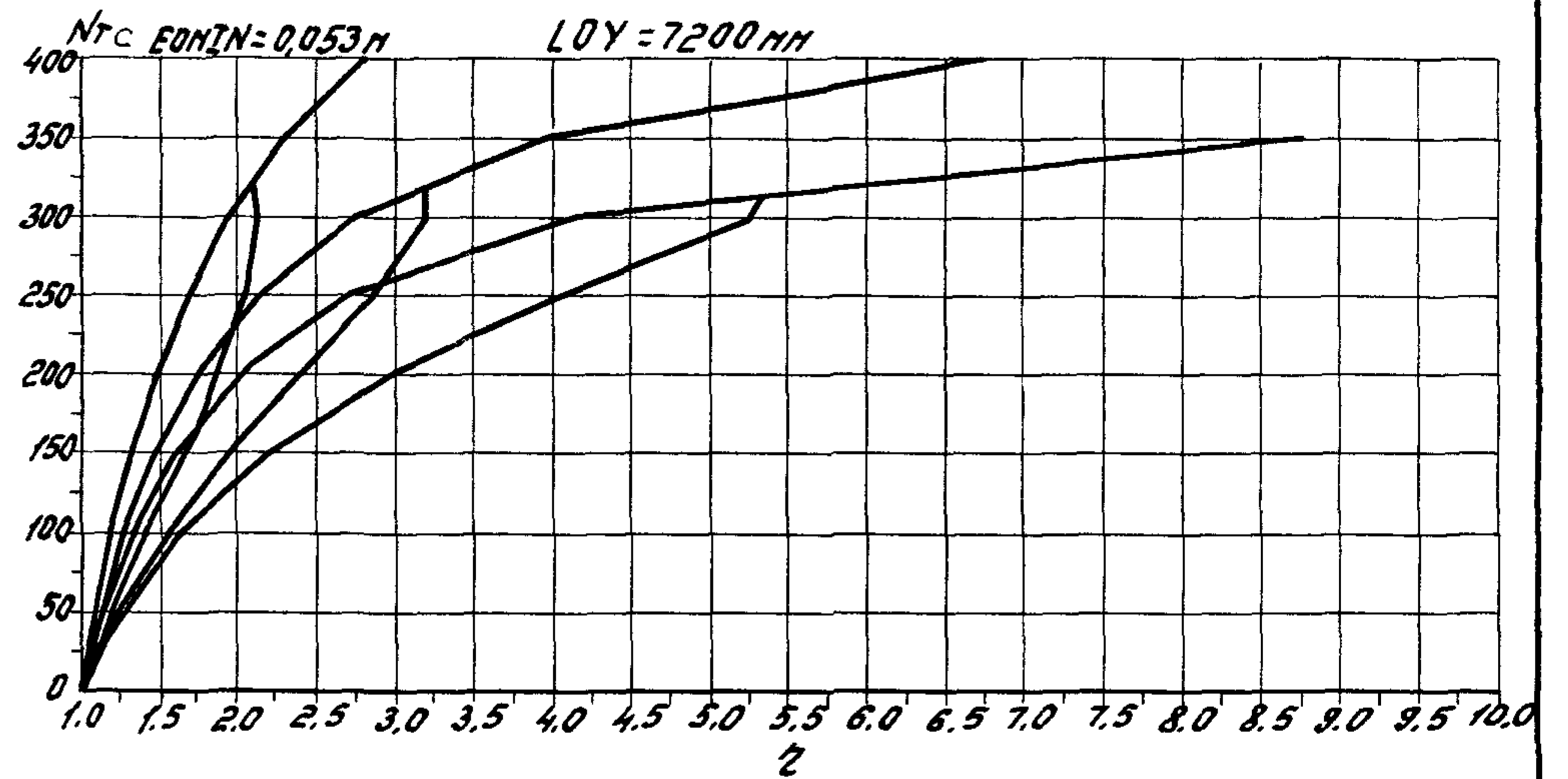
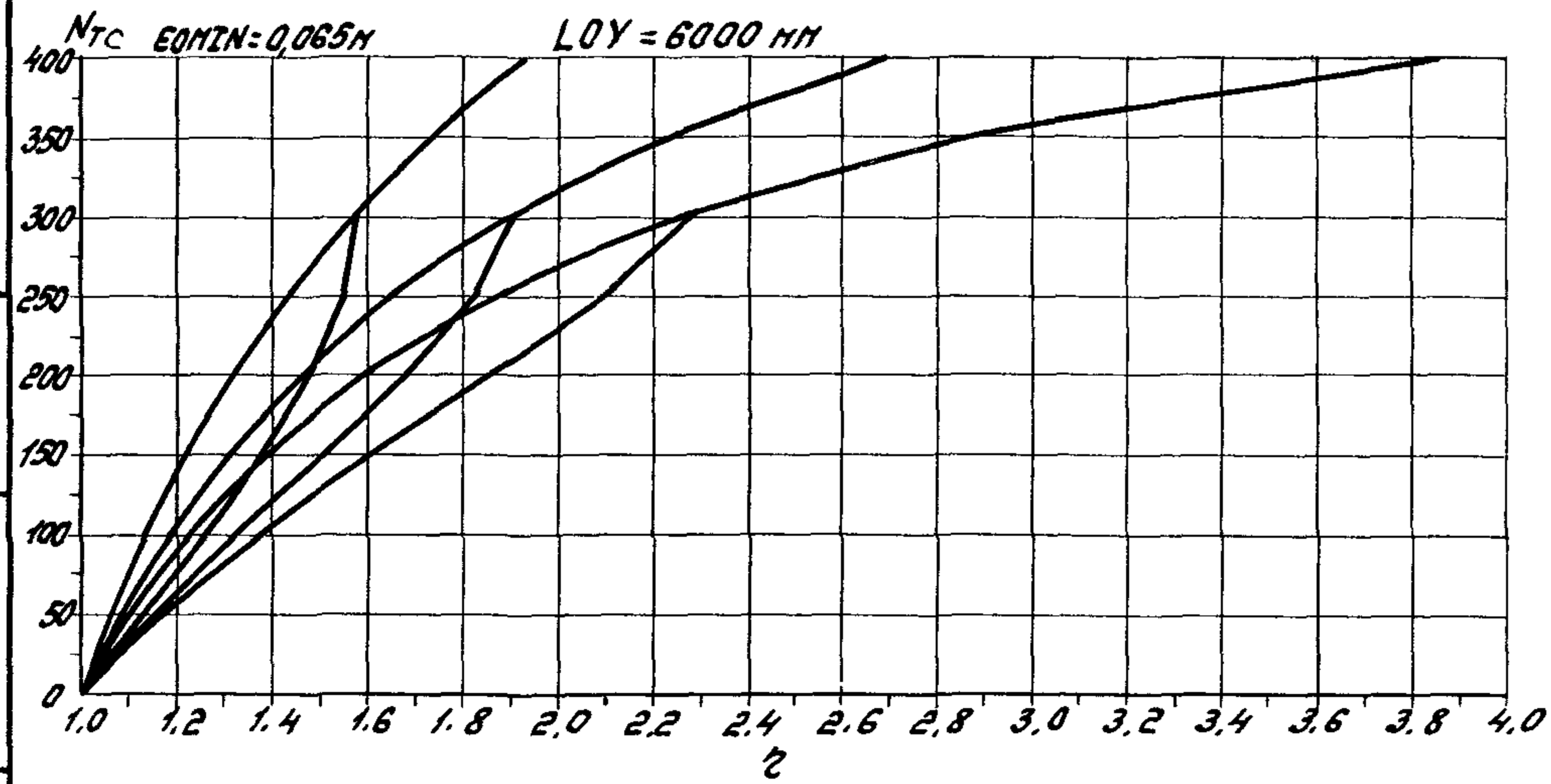
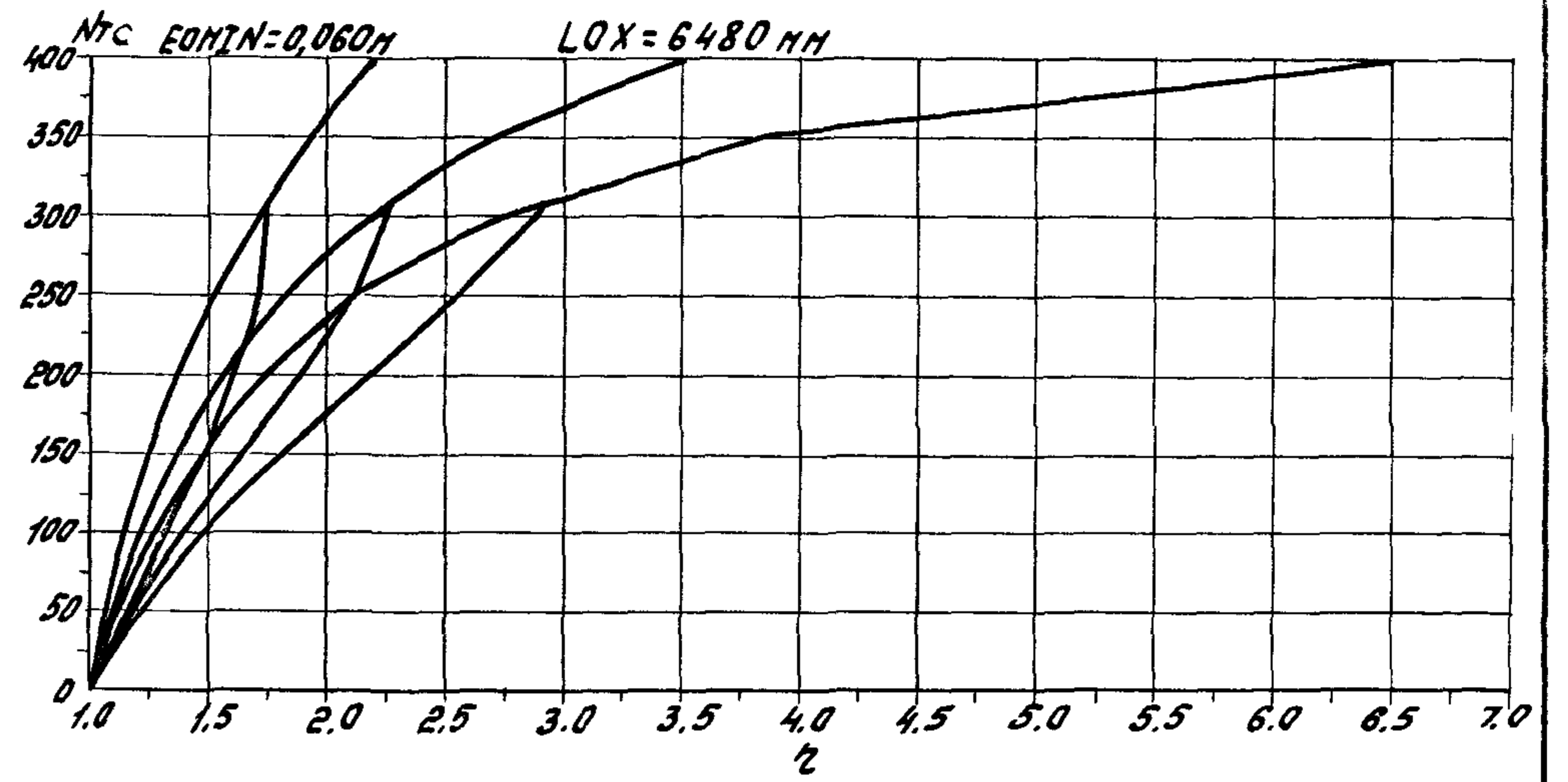
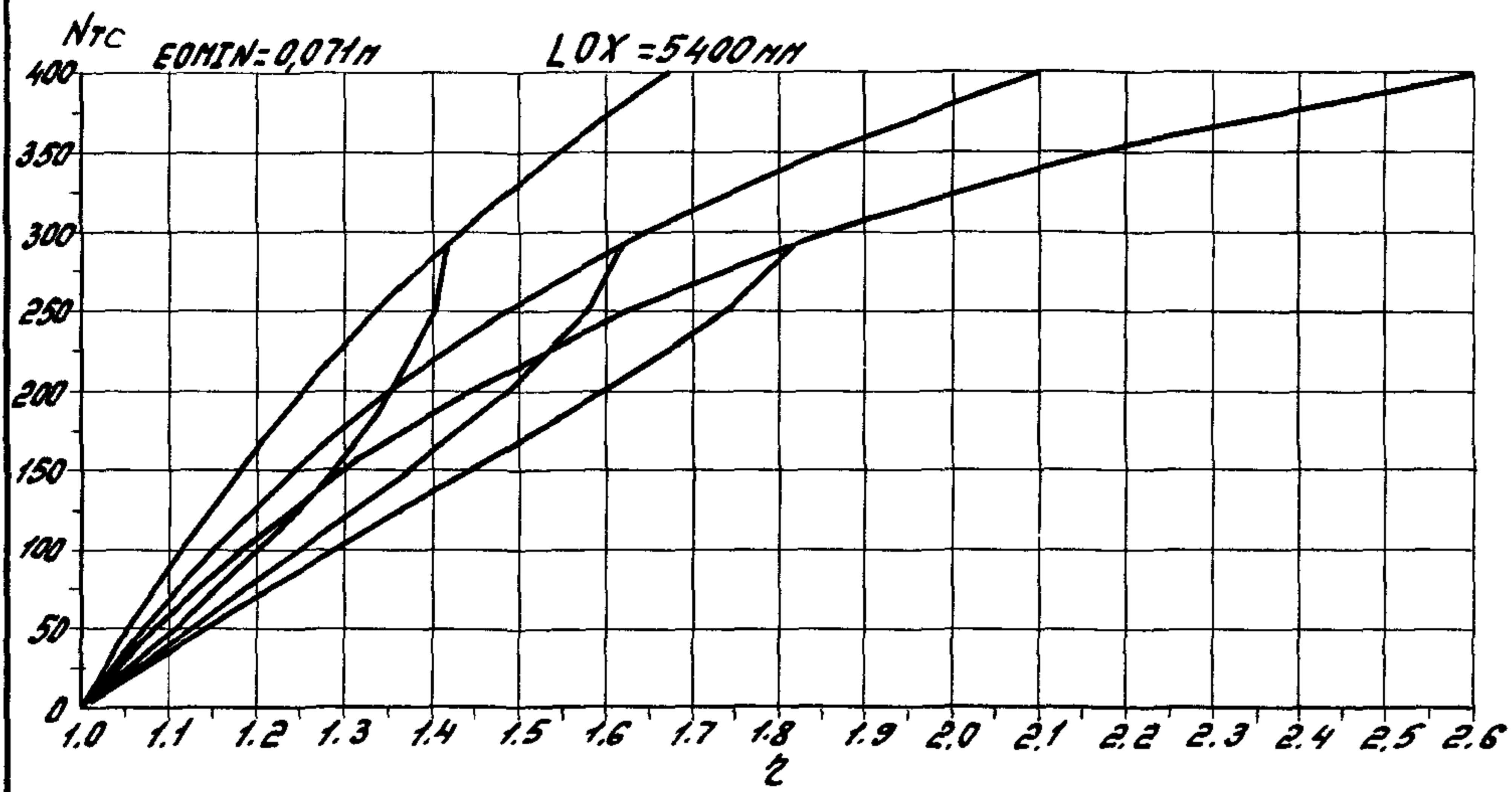

Инв. вычисл. машины и документации УИВ. №

1.020.1-4 0-9 002 Лист
180

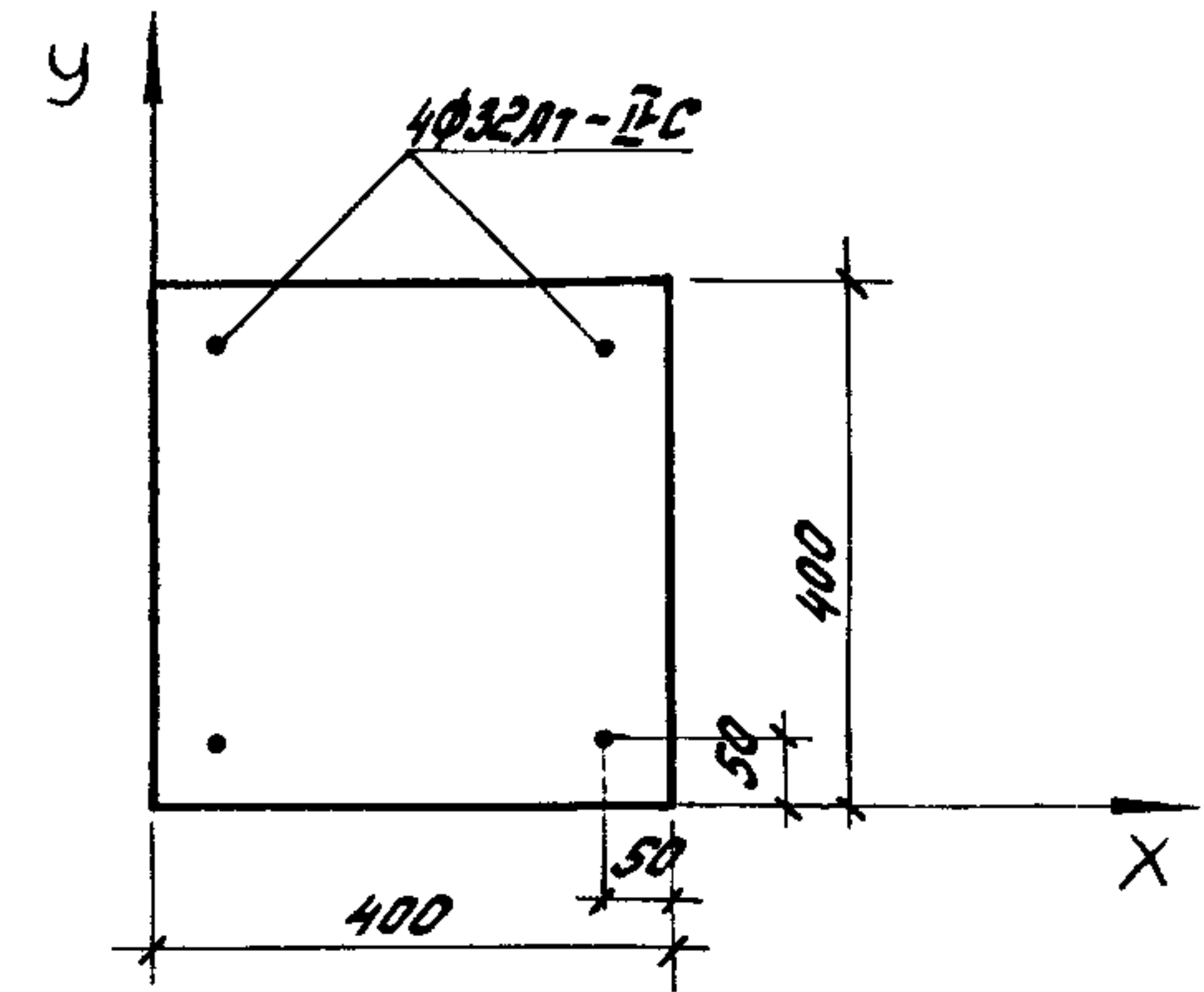
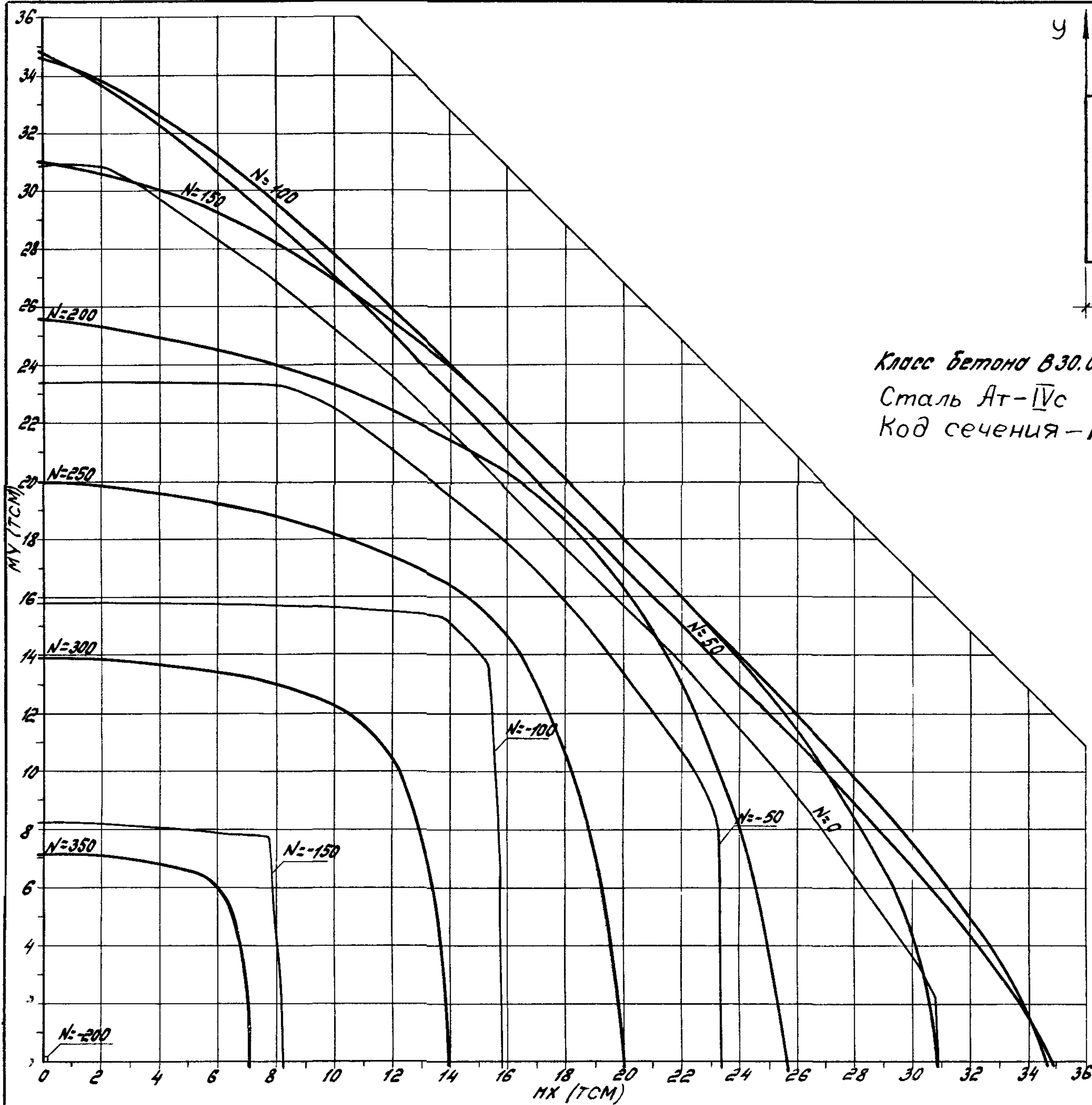

Класс бетона В30.0 ($R_b = 15.3$ МПа при учёте $\gamma_{b2} = 0.90$)
Сталь Ат-IVс
Код сечения - 1235

1.020.1-4 0-9 002

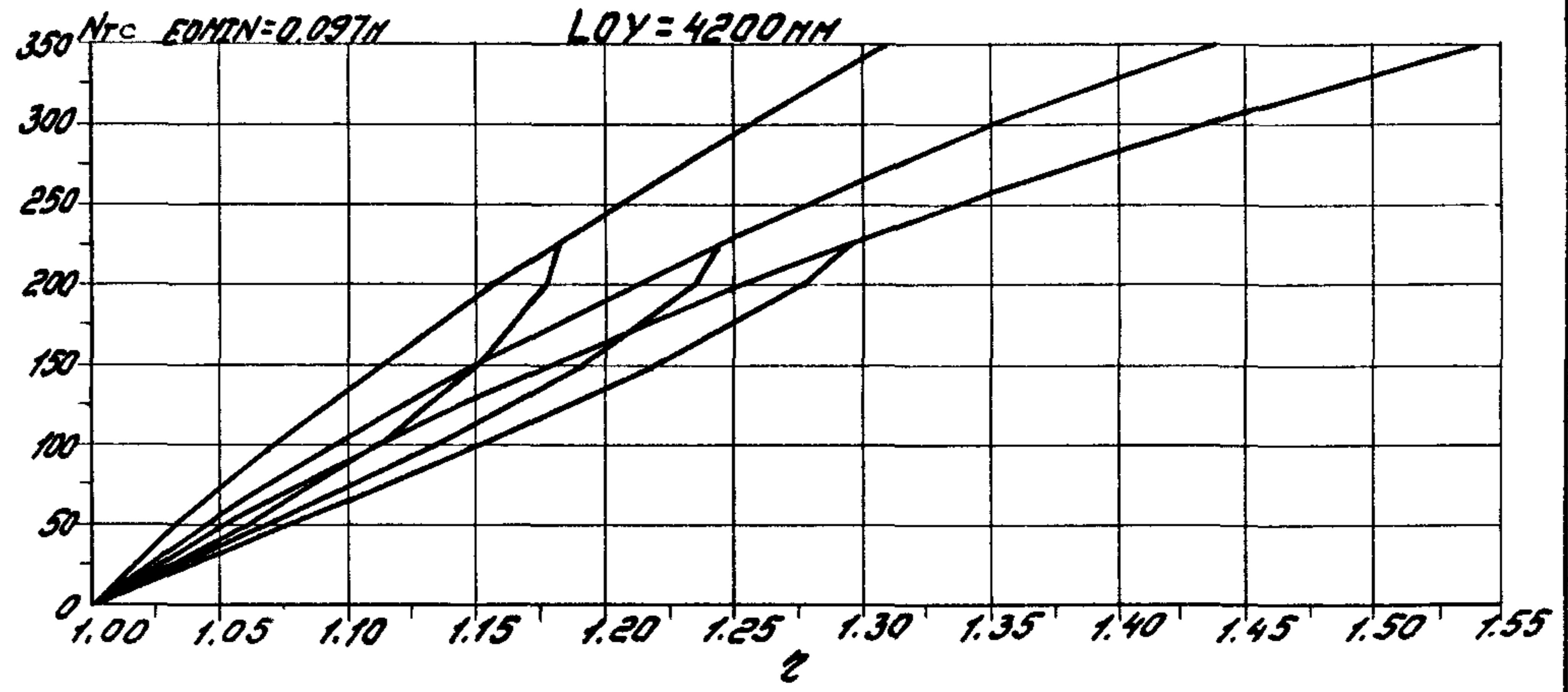
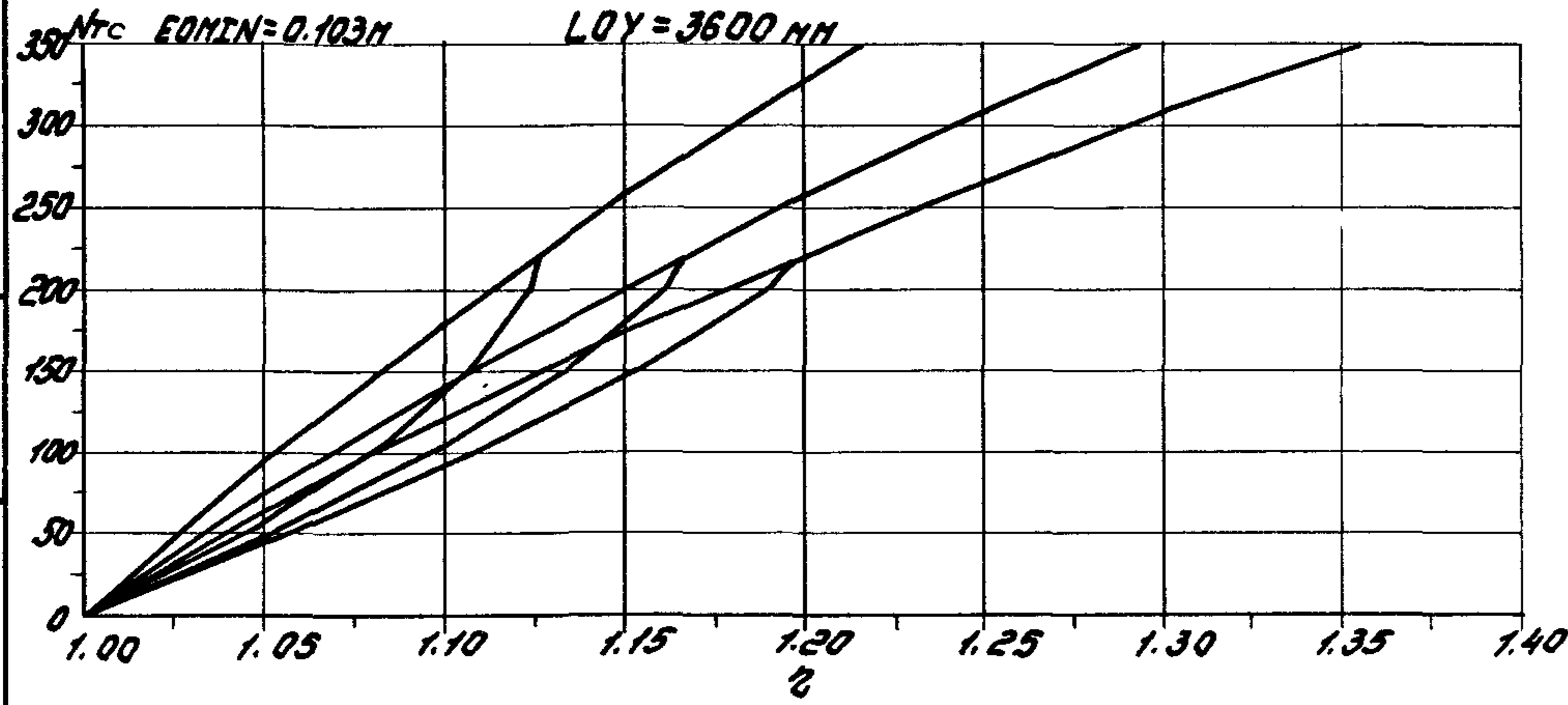
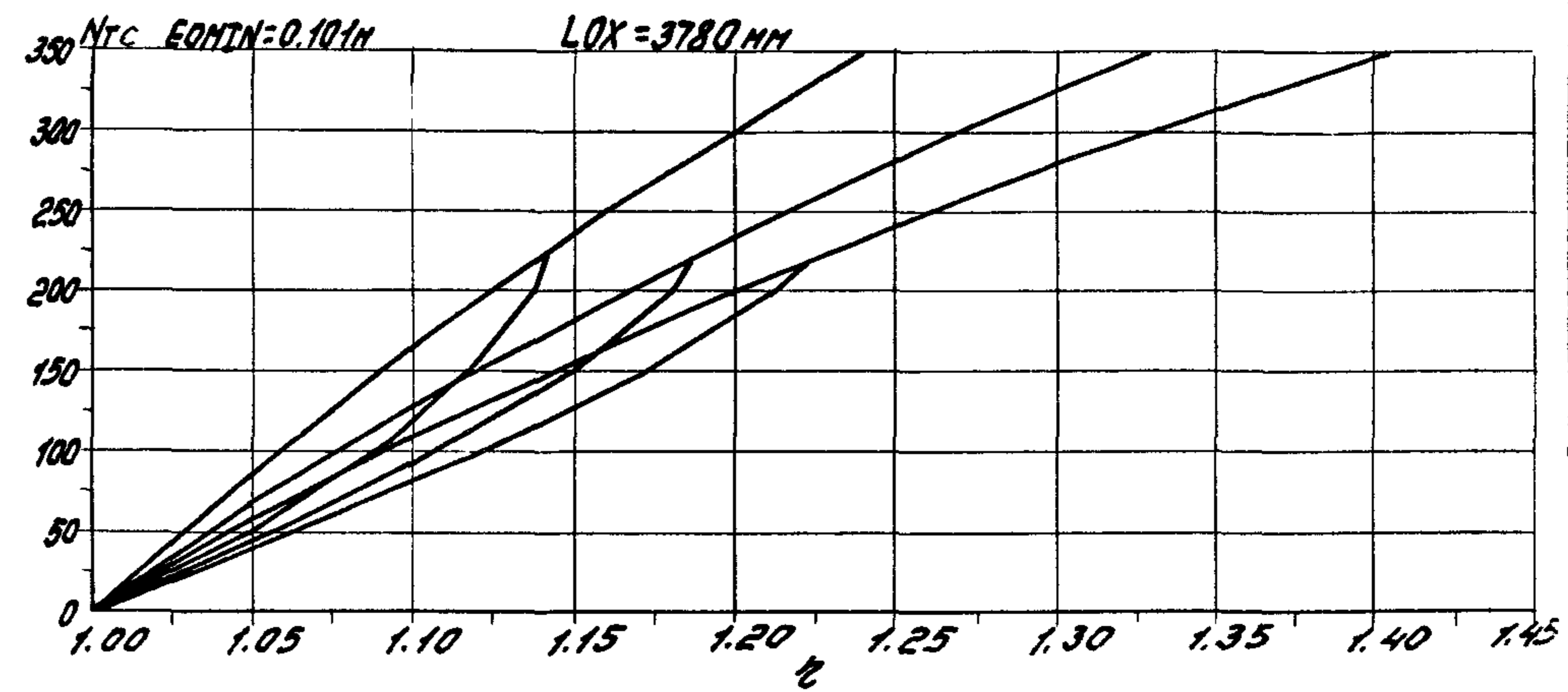
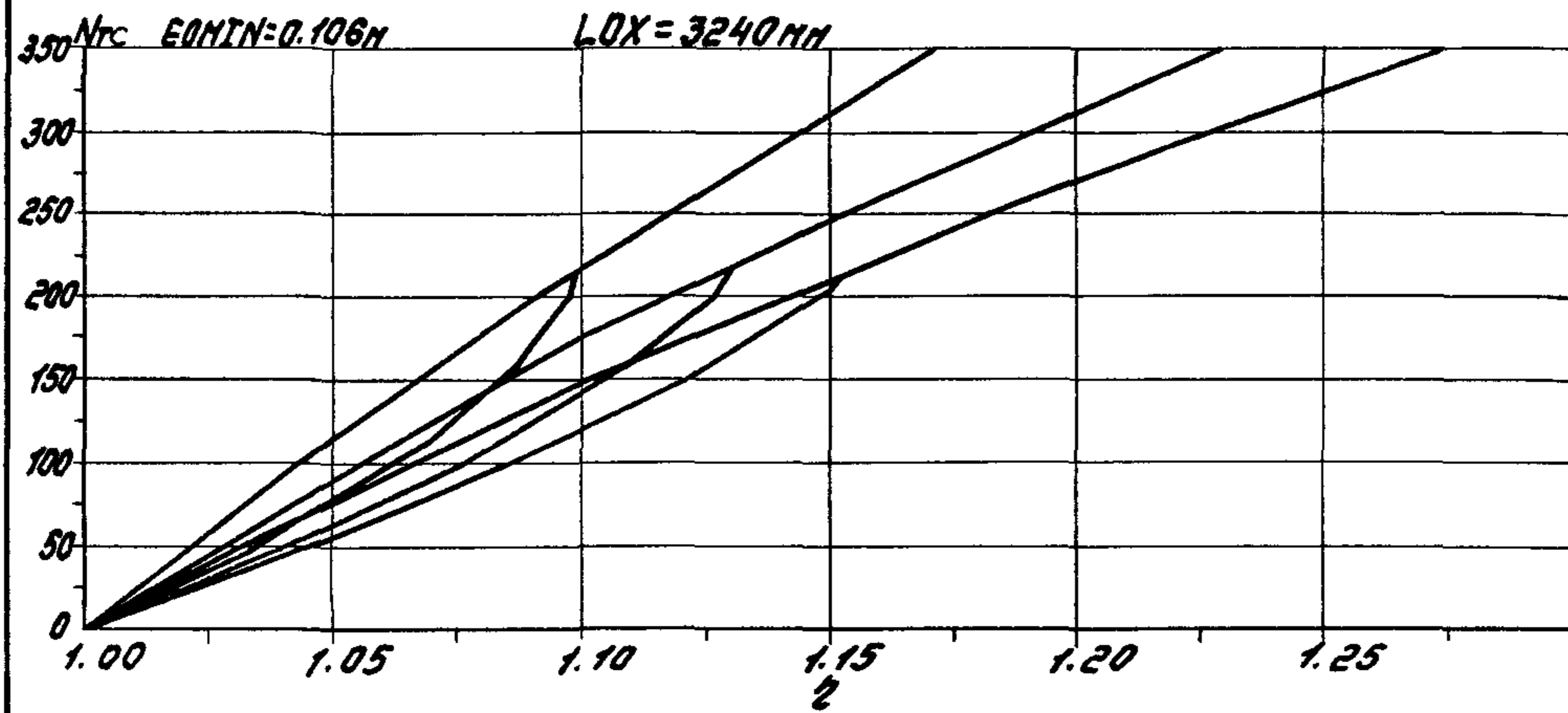

Кривые по методу Рунге-Кутты

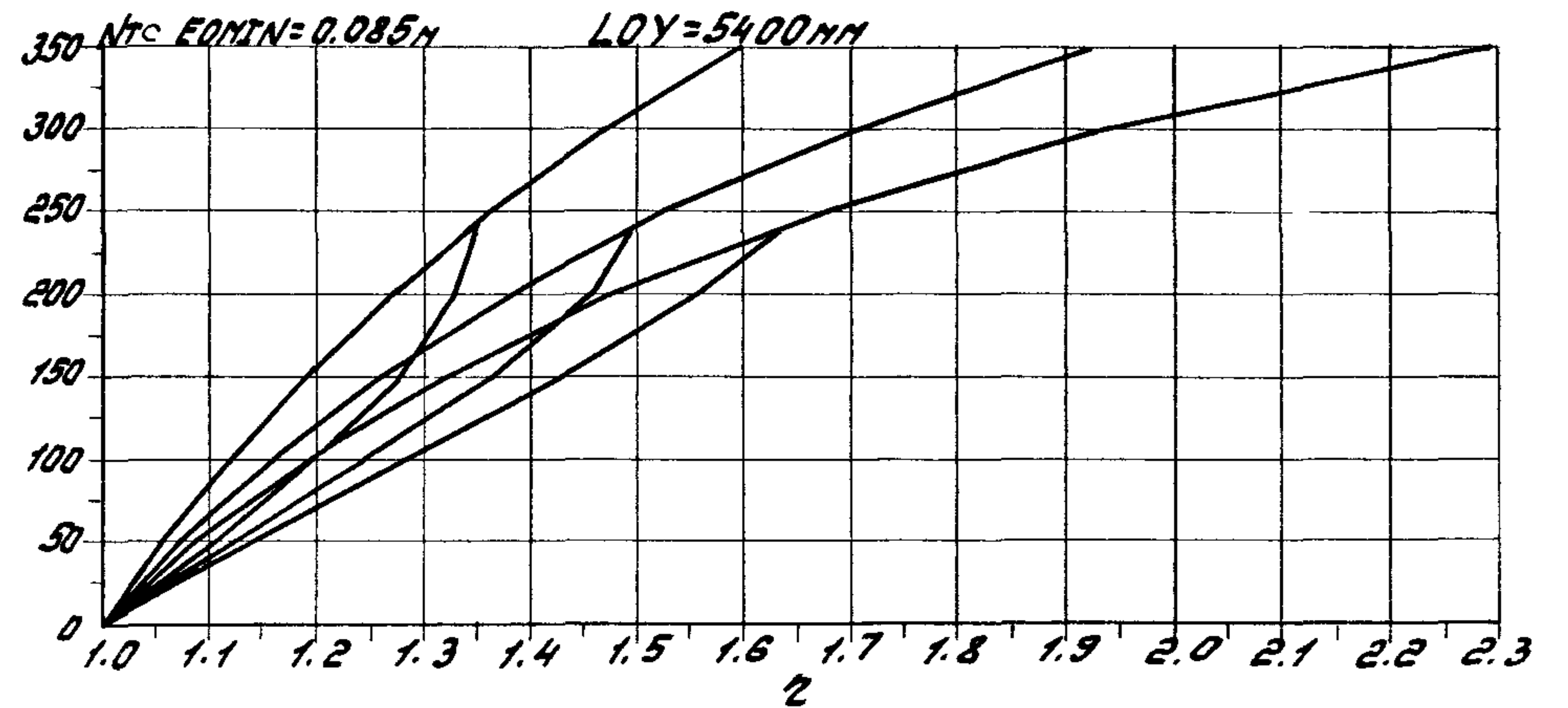
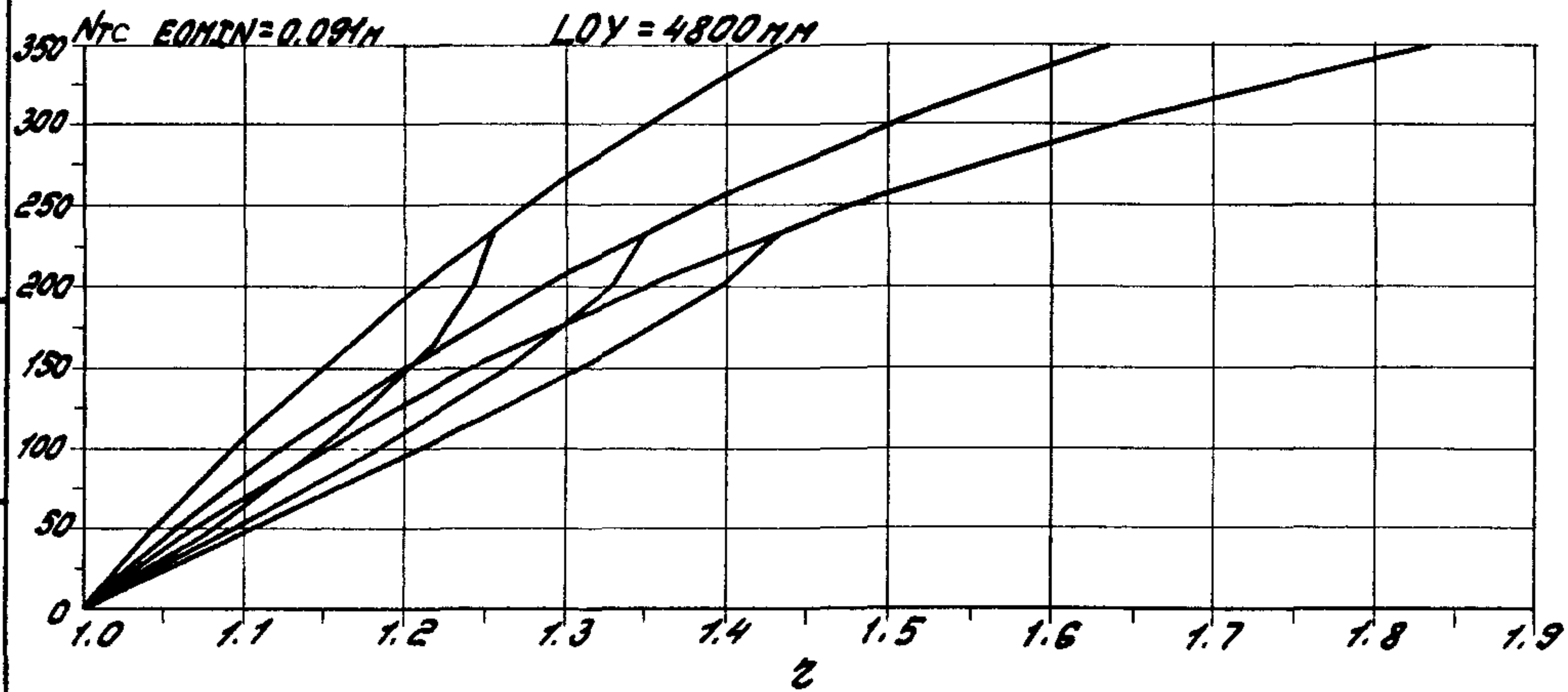
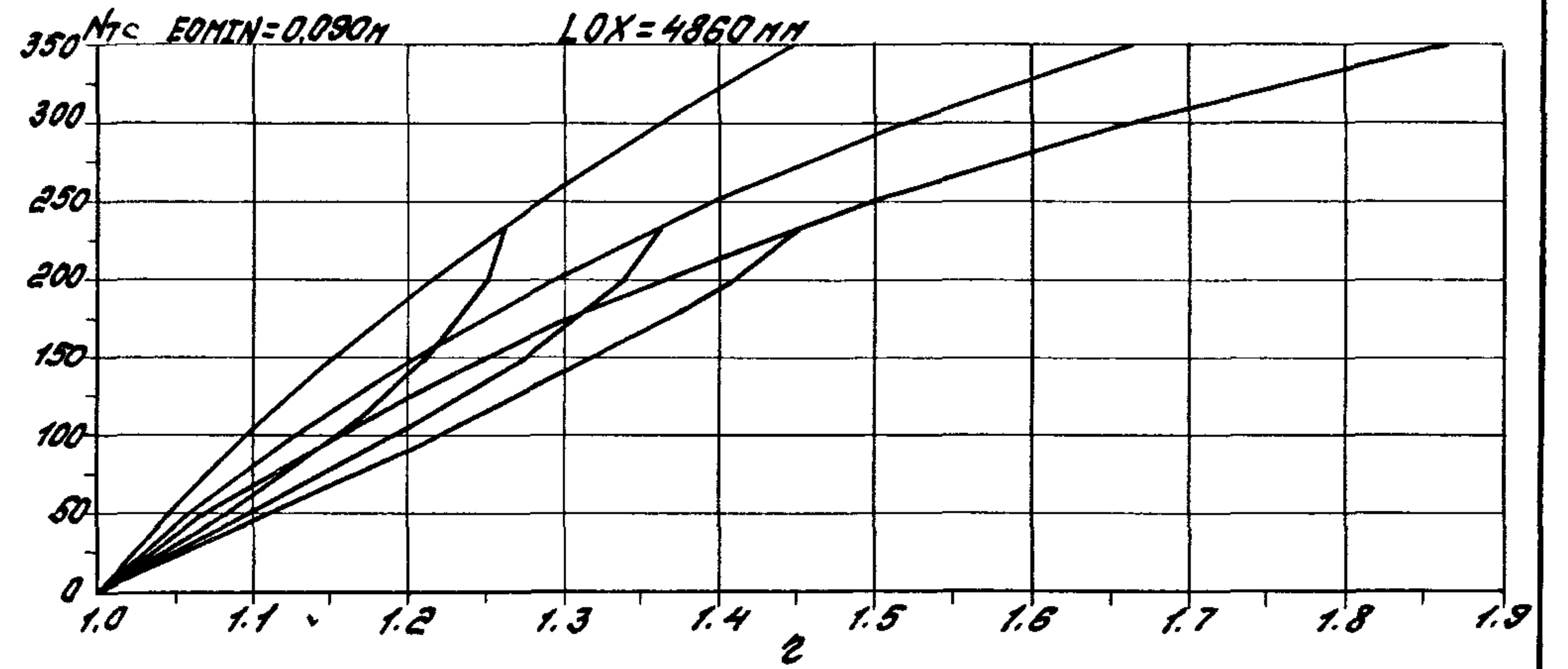
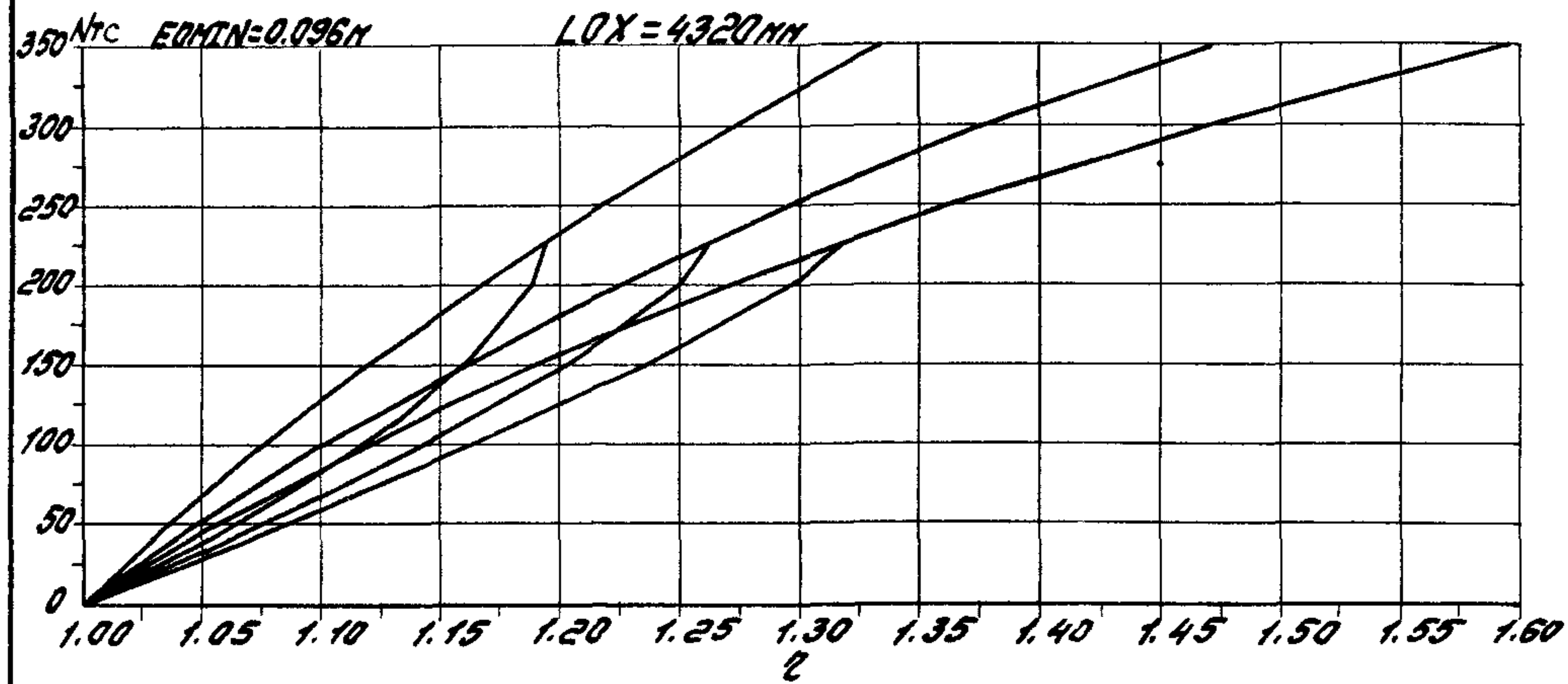

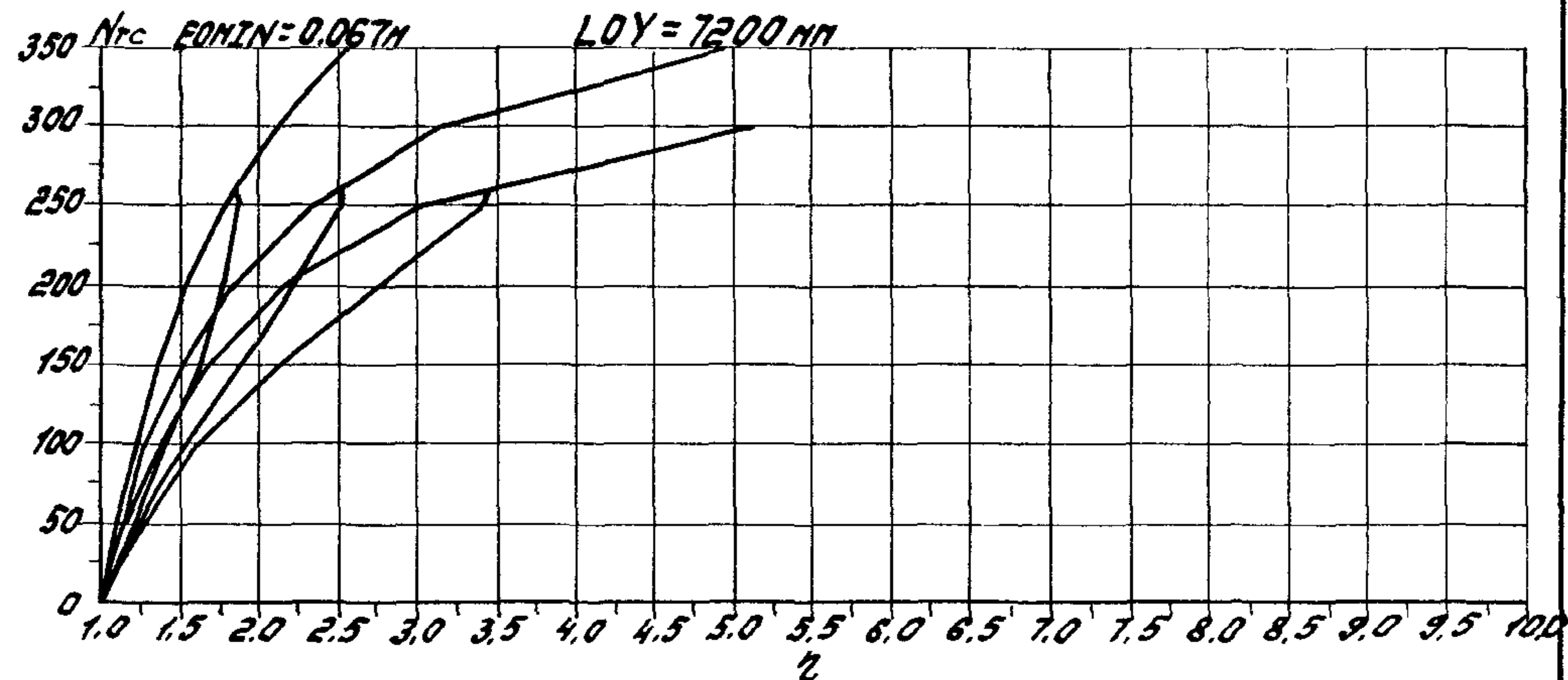
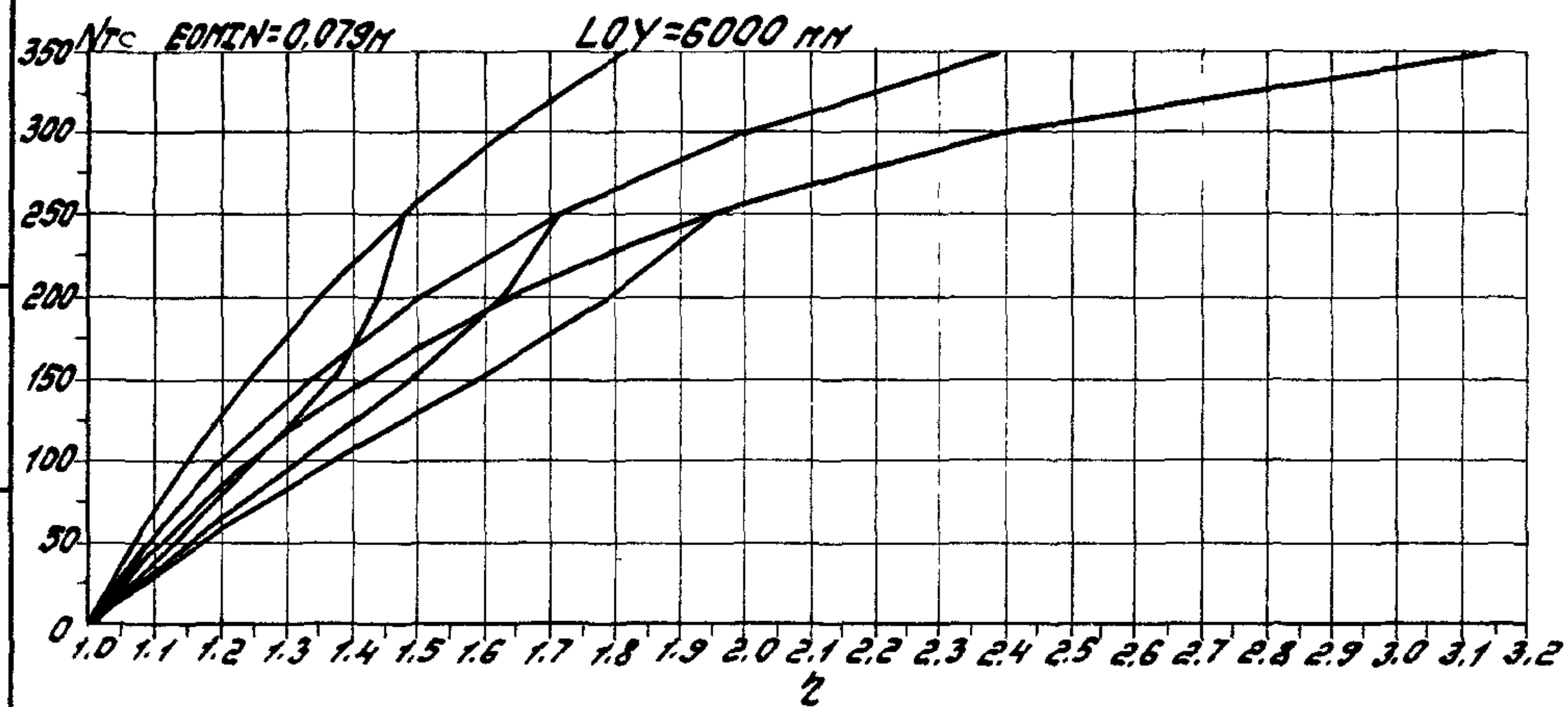
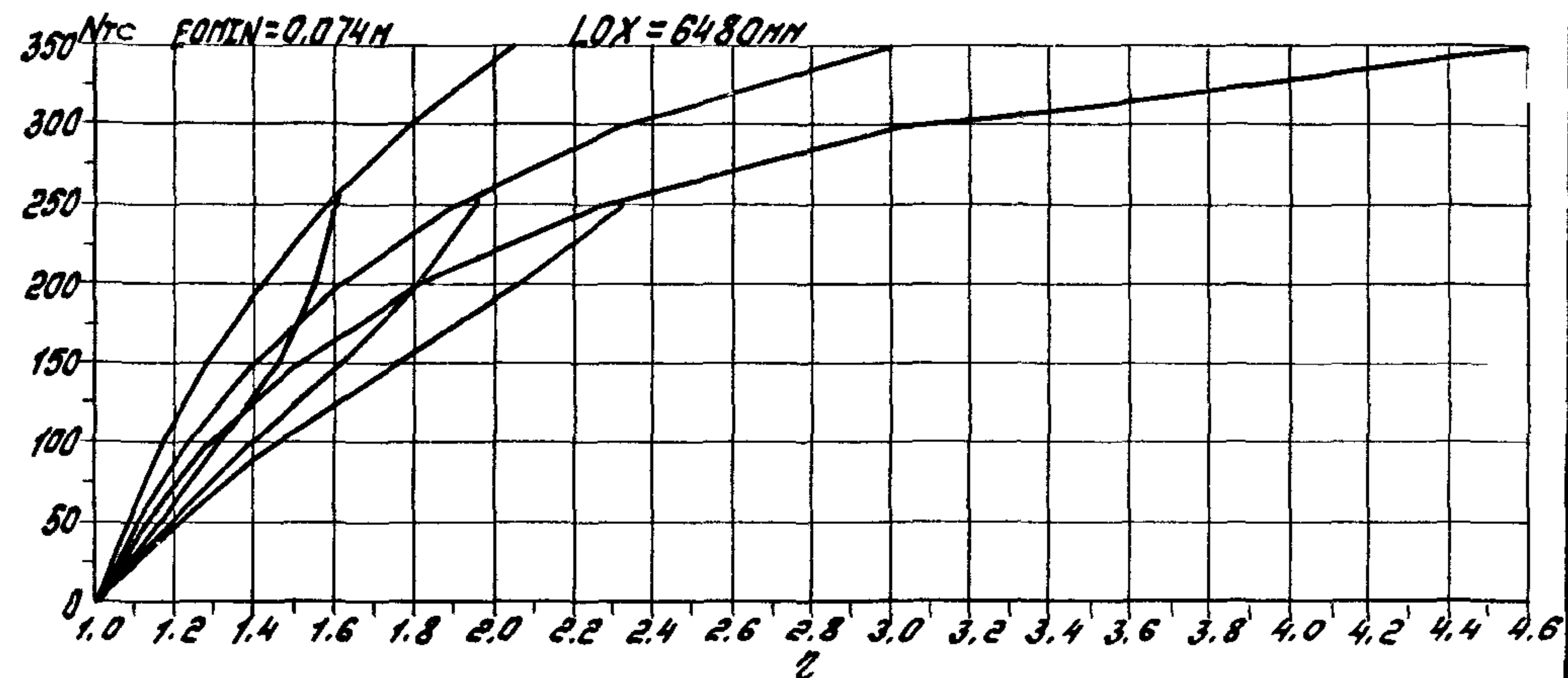
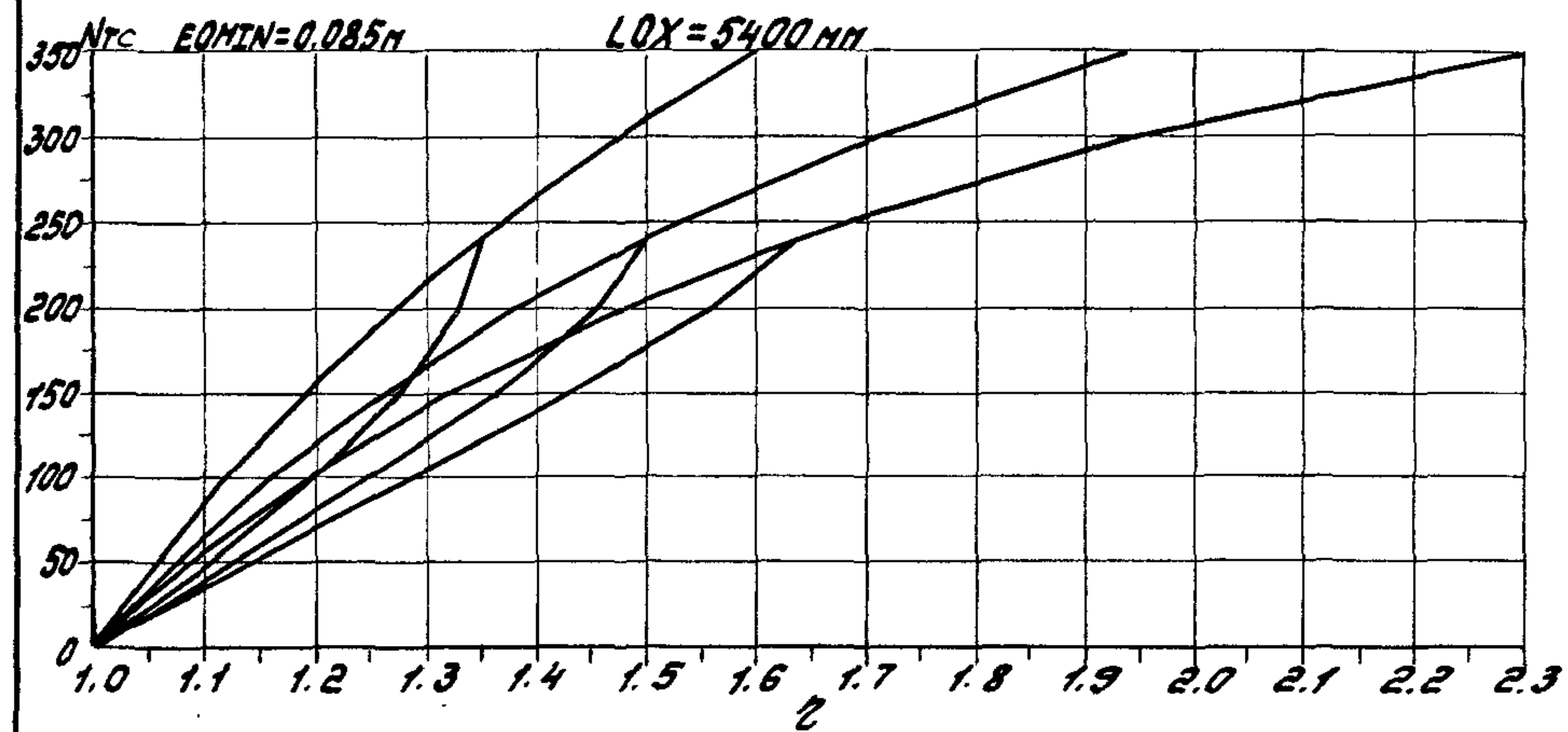

Учб. № 100111 Подпись и дата Взам. инв. №

1.020.1-4 0-9 002 184

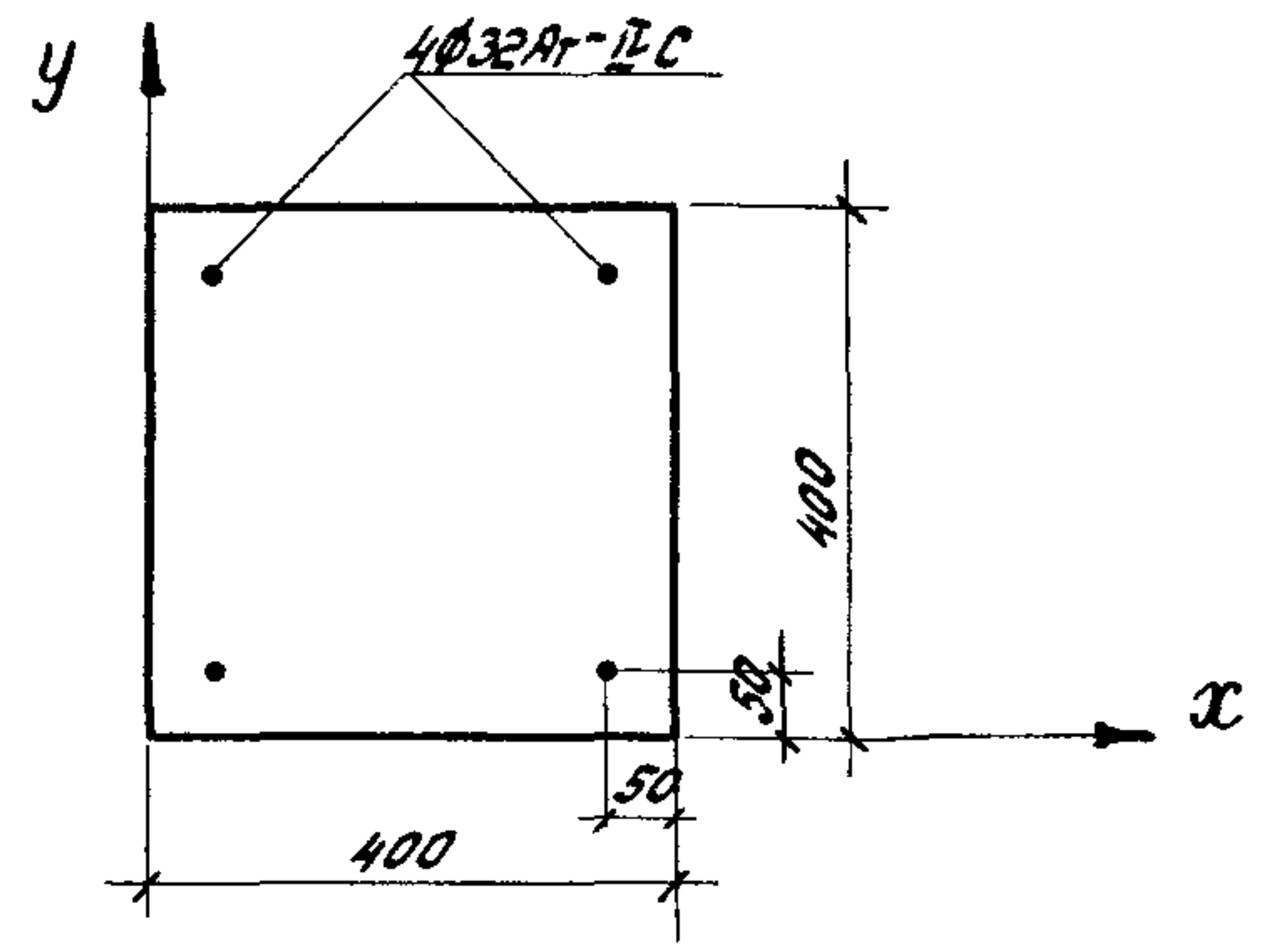
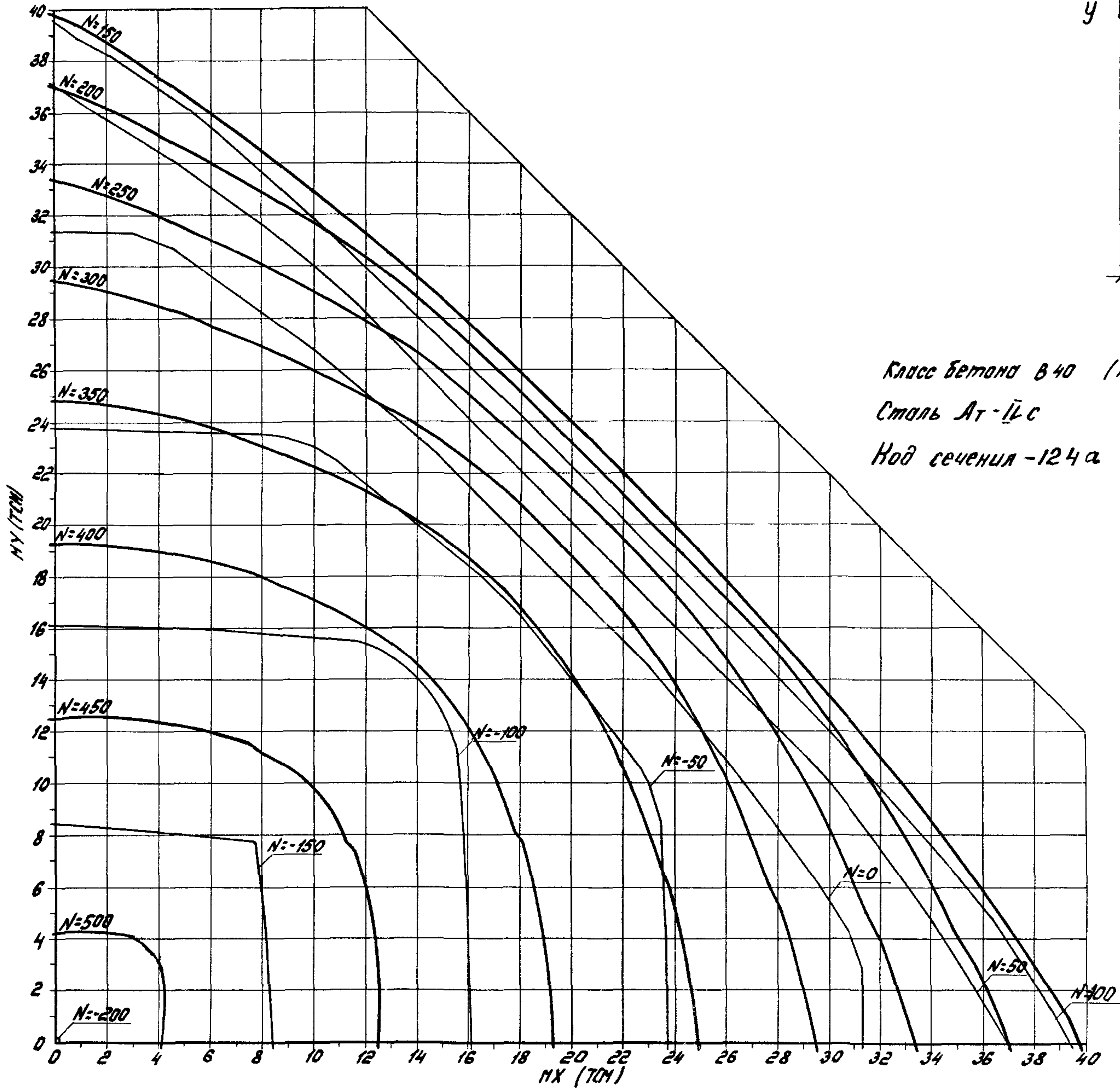

Класс бетона В40 ($R_b = 24,2 \text{ МПа}$ при учёте $\gamma_{b2} = 1,10$)
 Сталь Ar-IIc
 Ноd сечения -124a

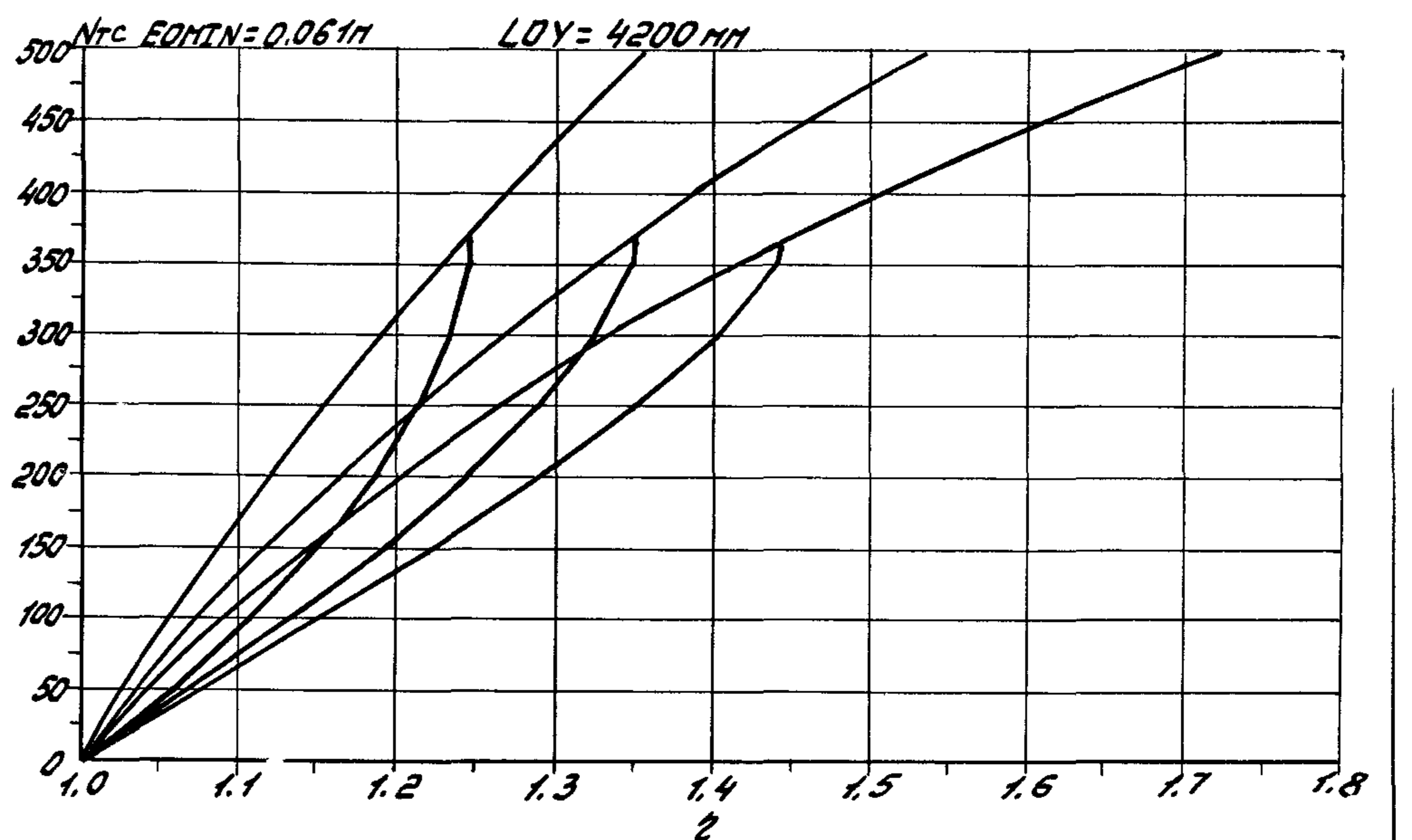
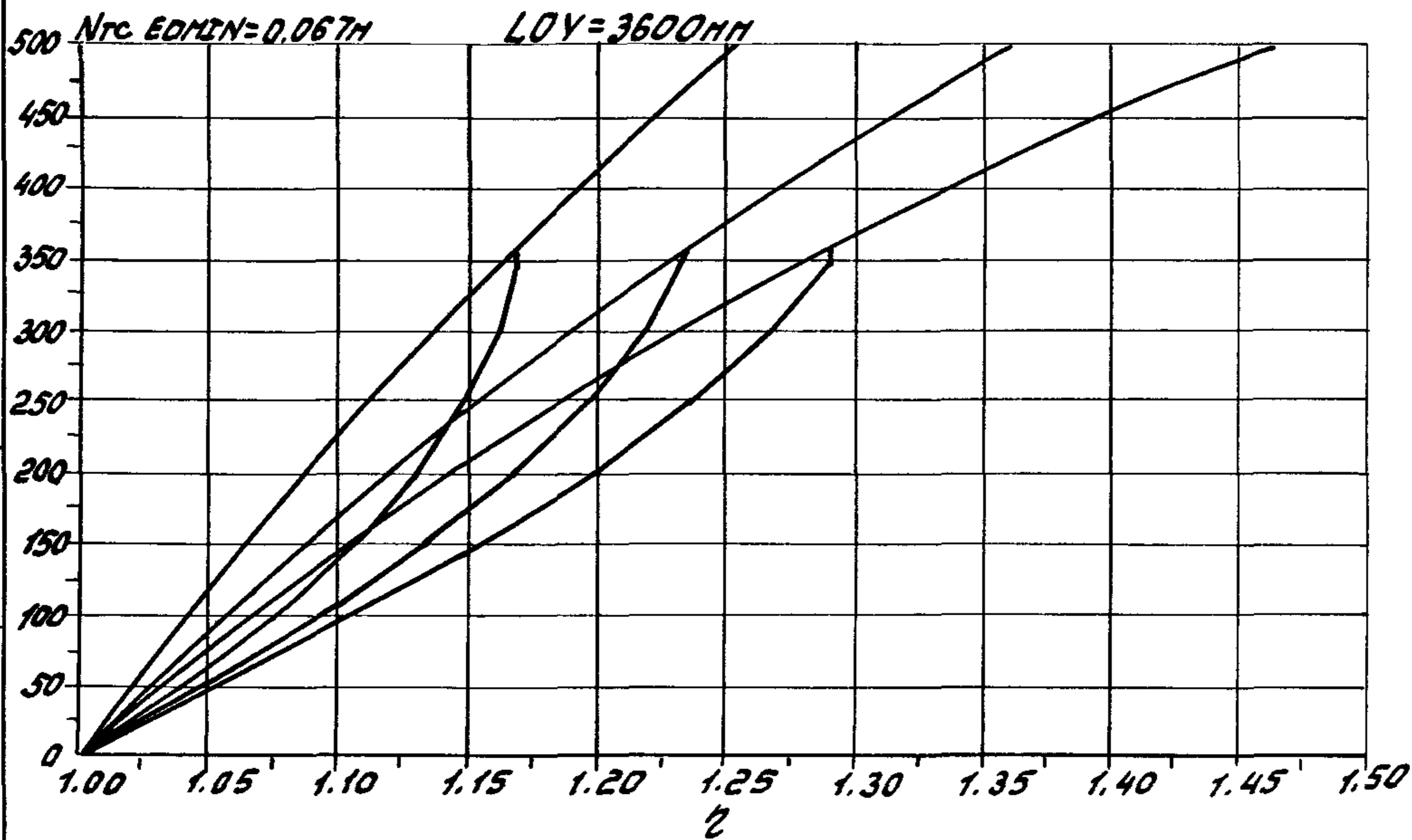
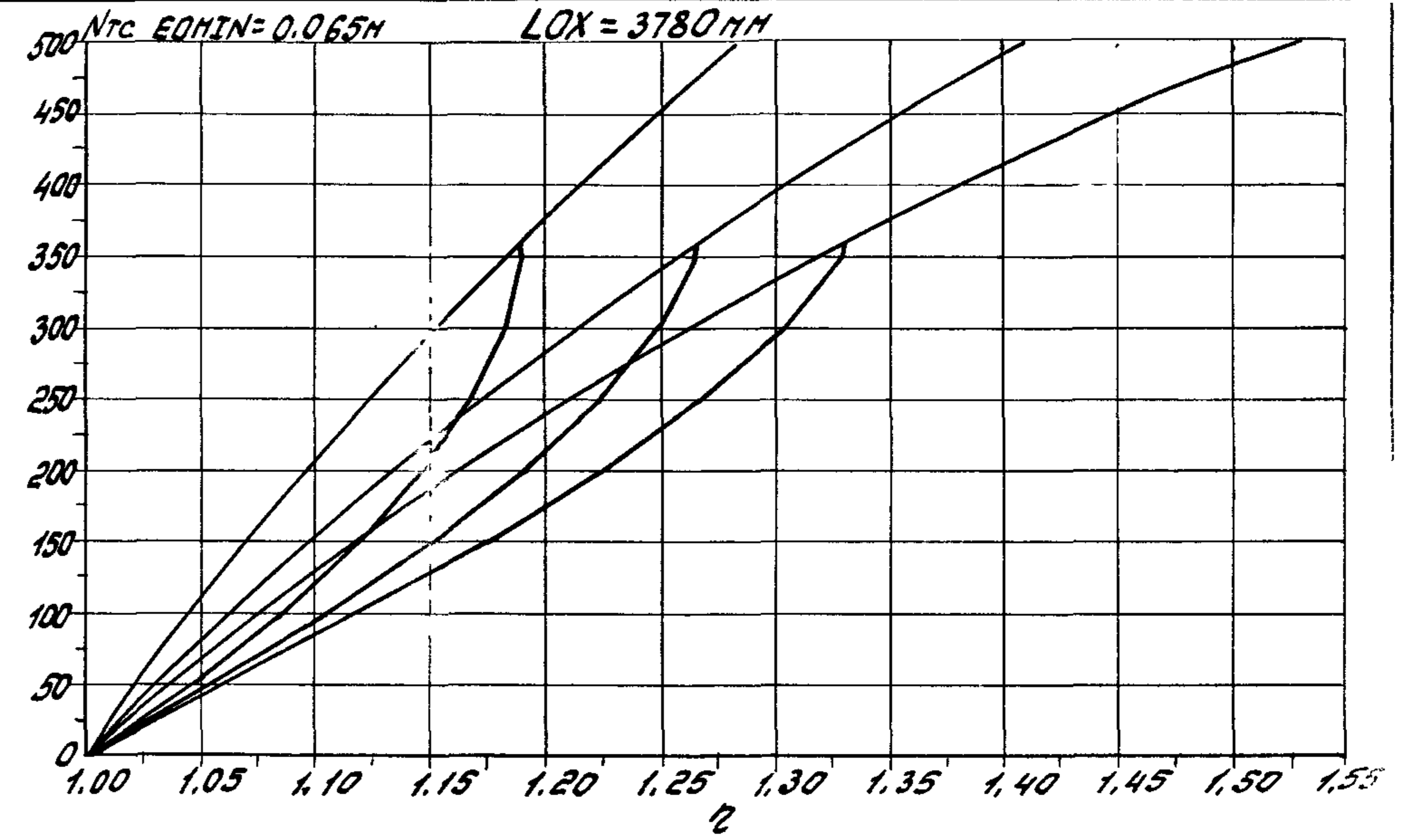
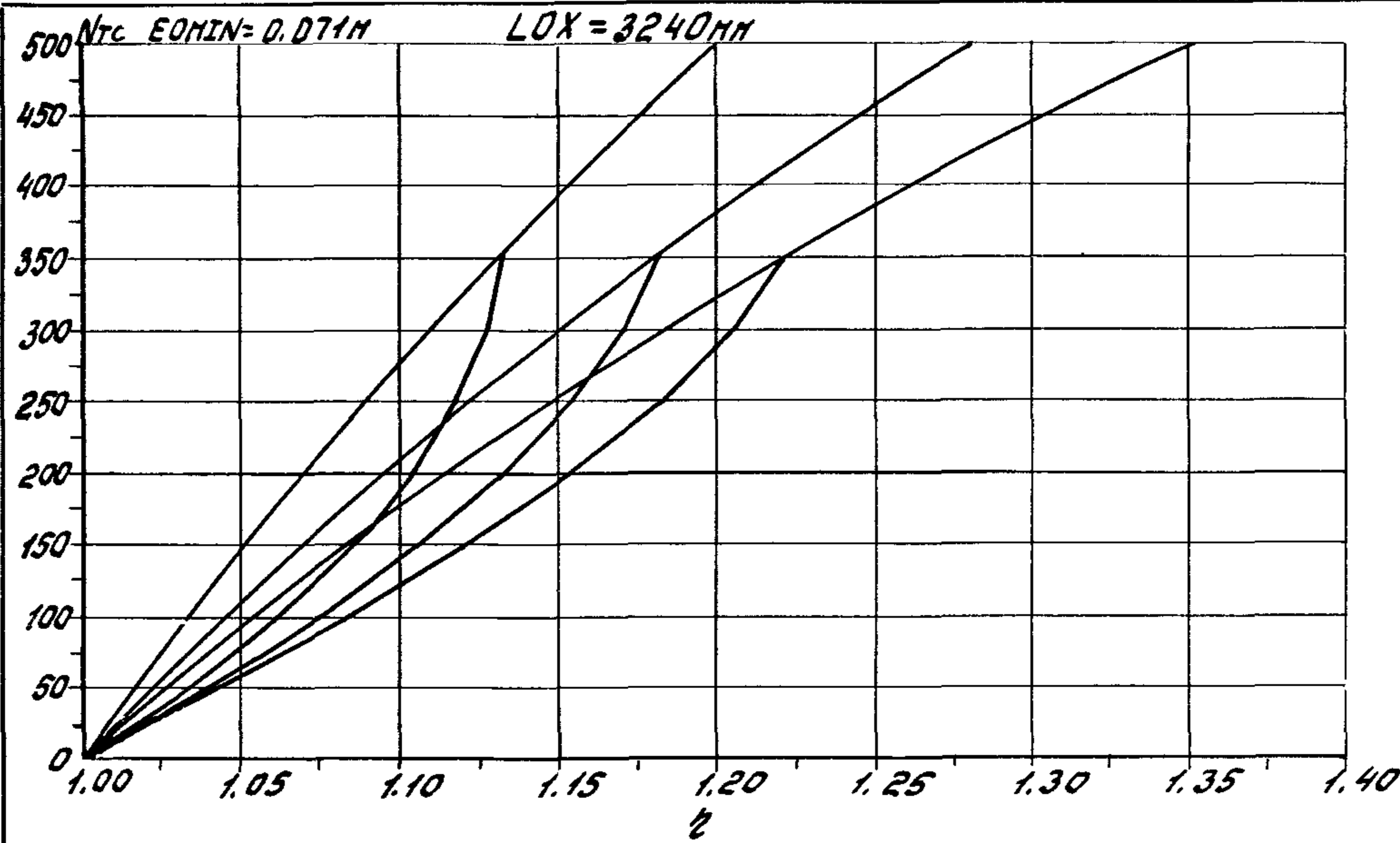

1.020.1-4 0-9 002 Nrc
186

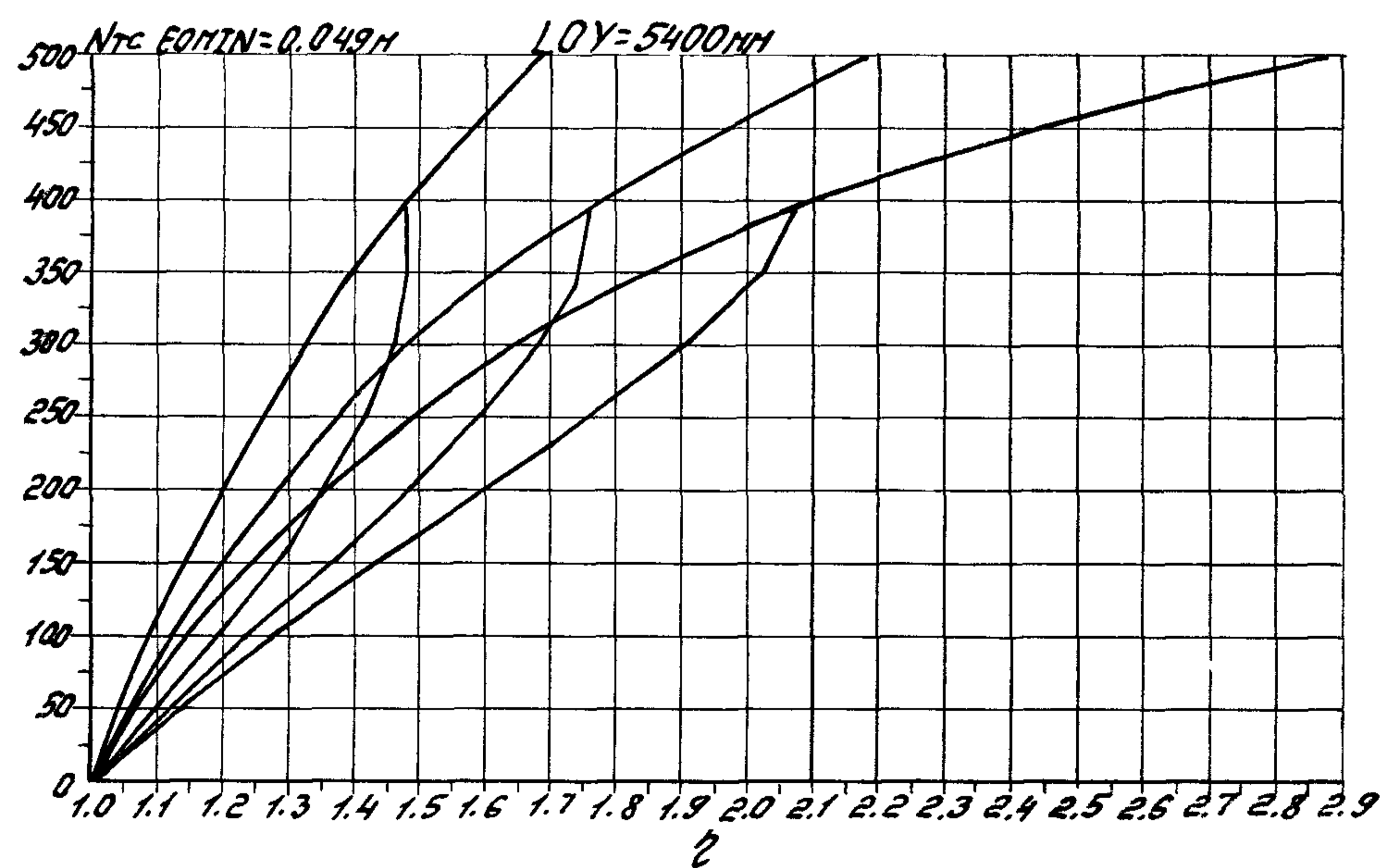
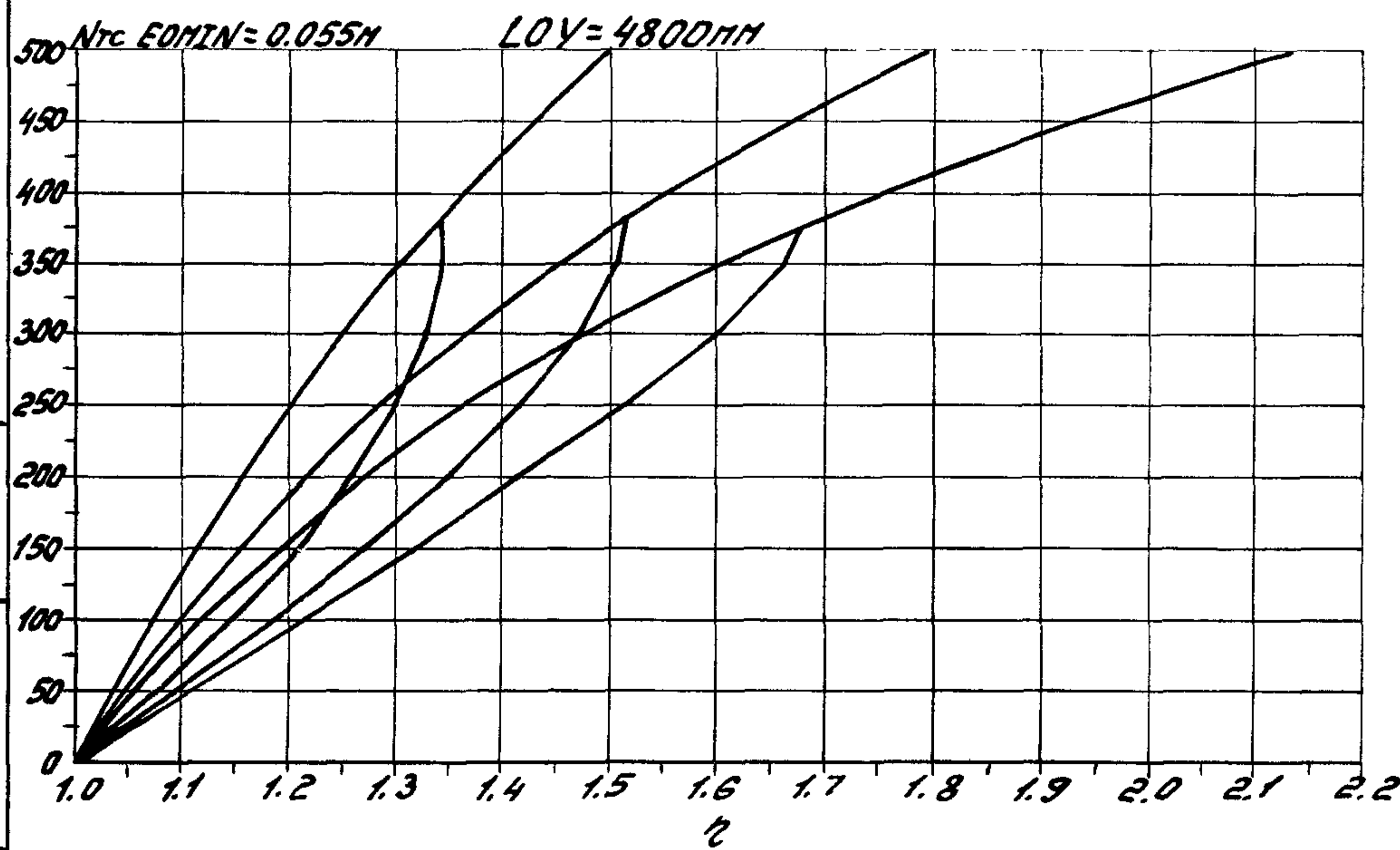
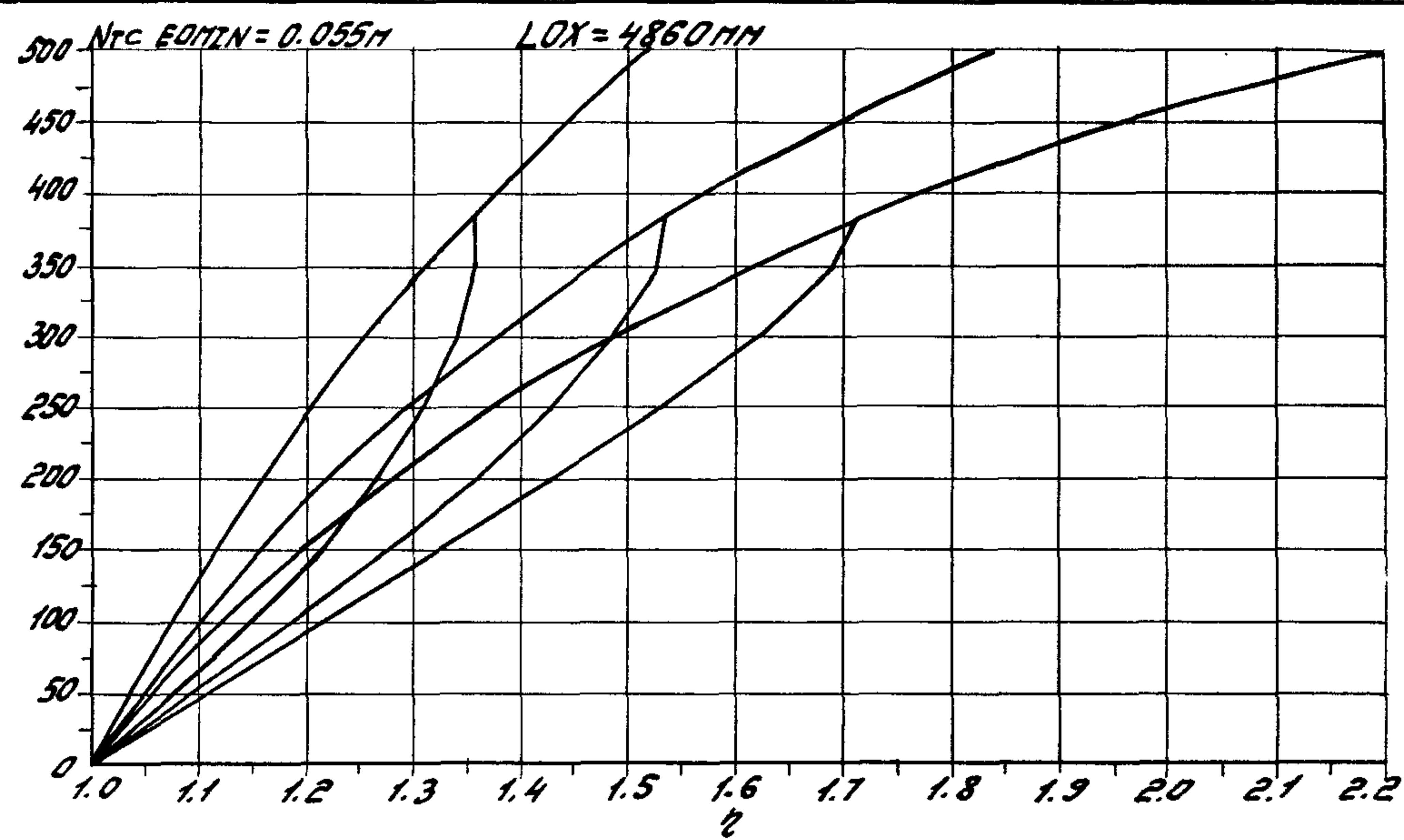
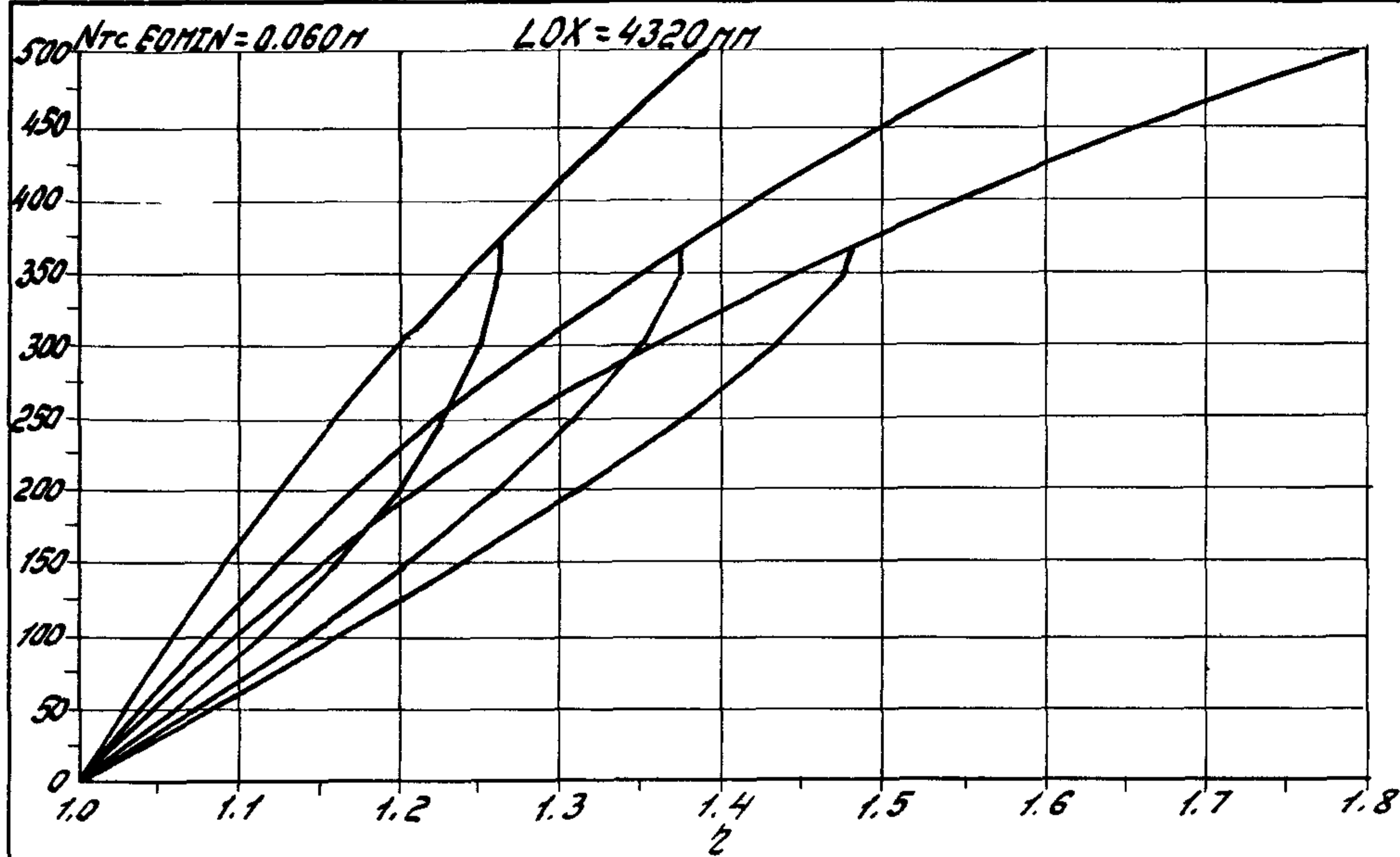

Уч. работа. Подпись

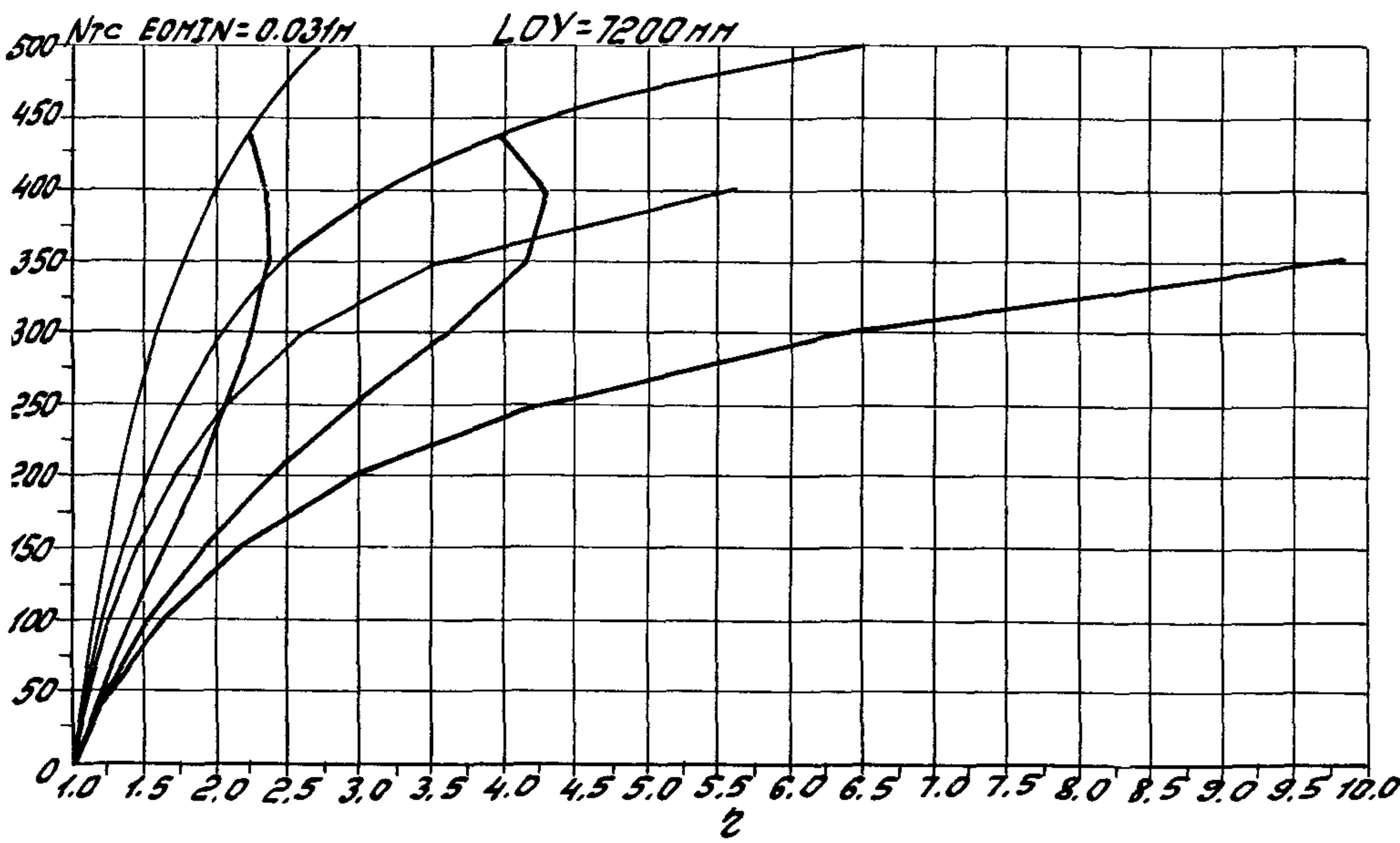
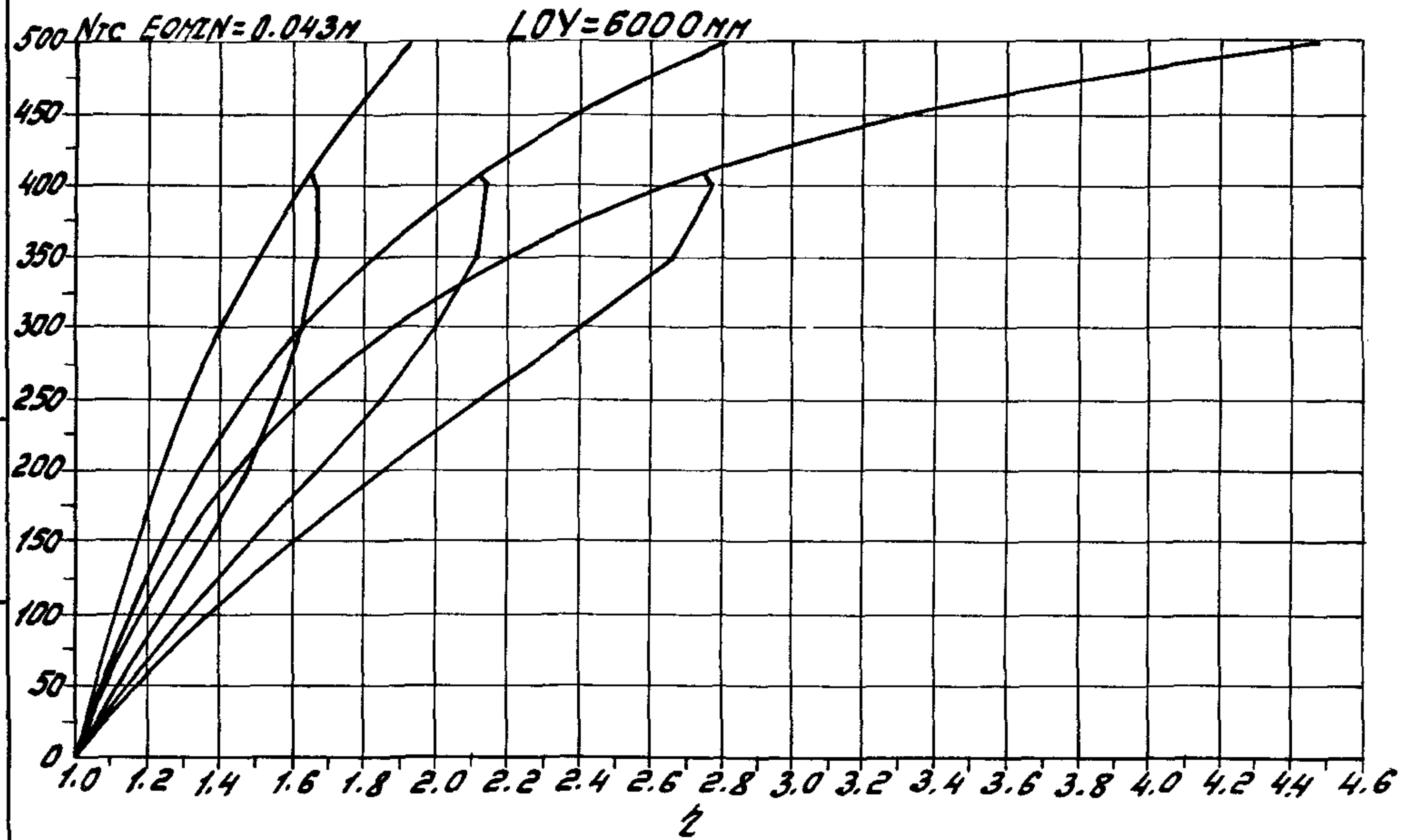
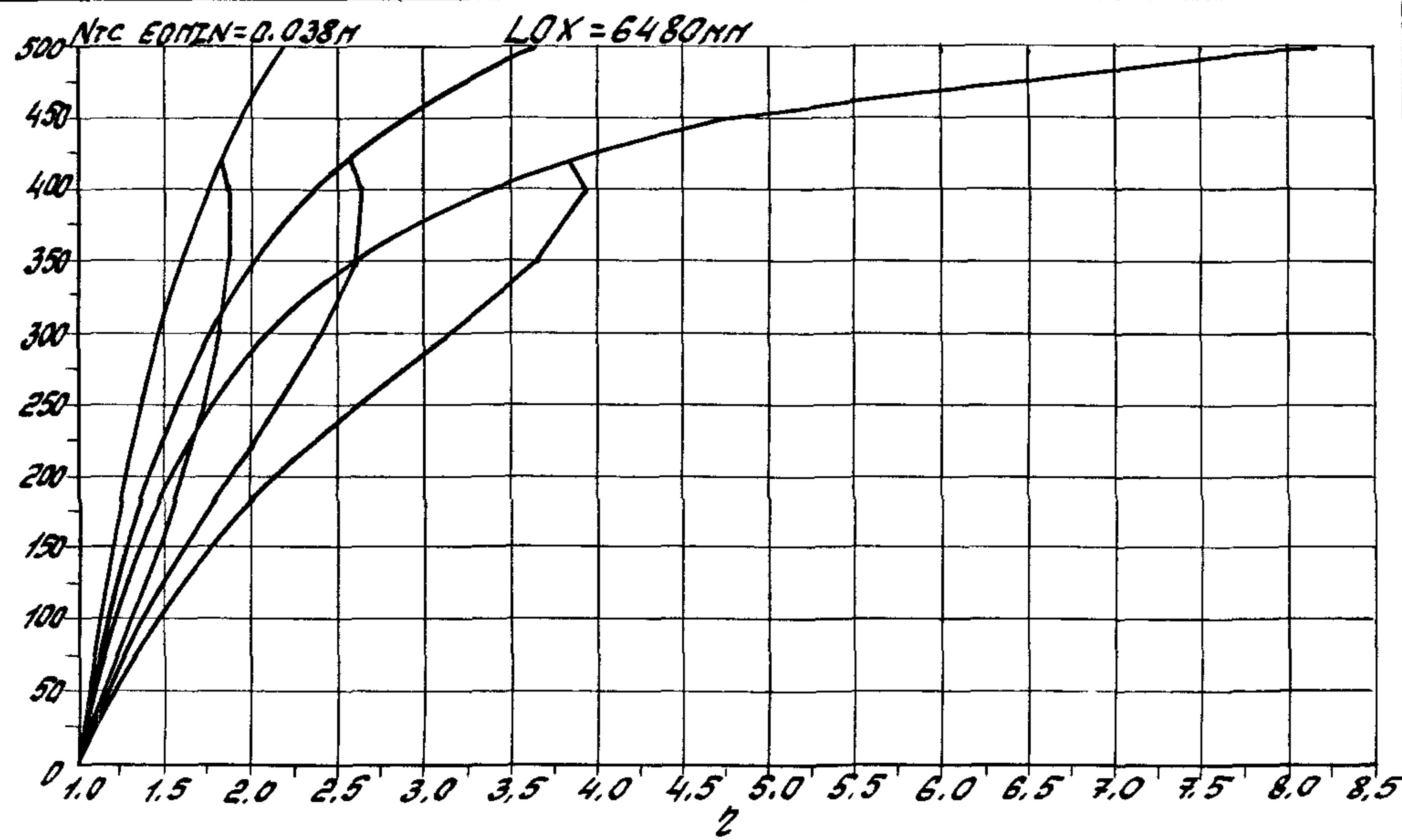
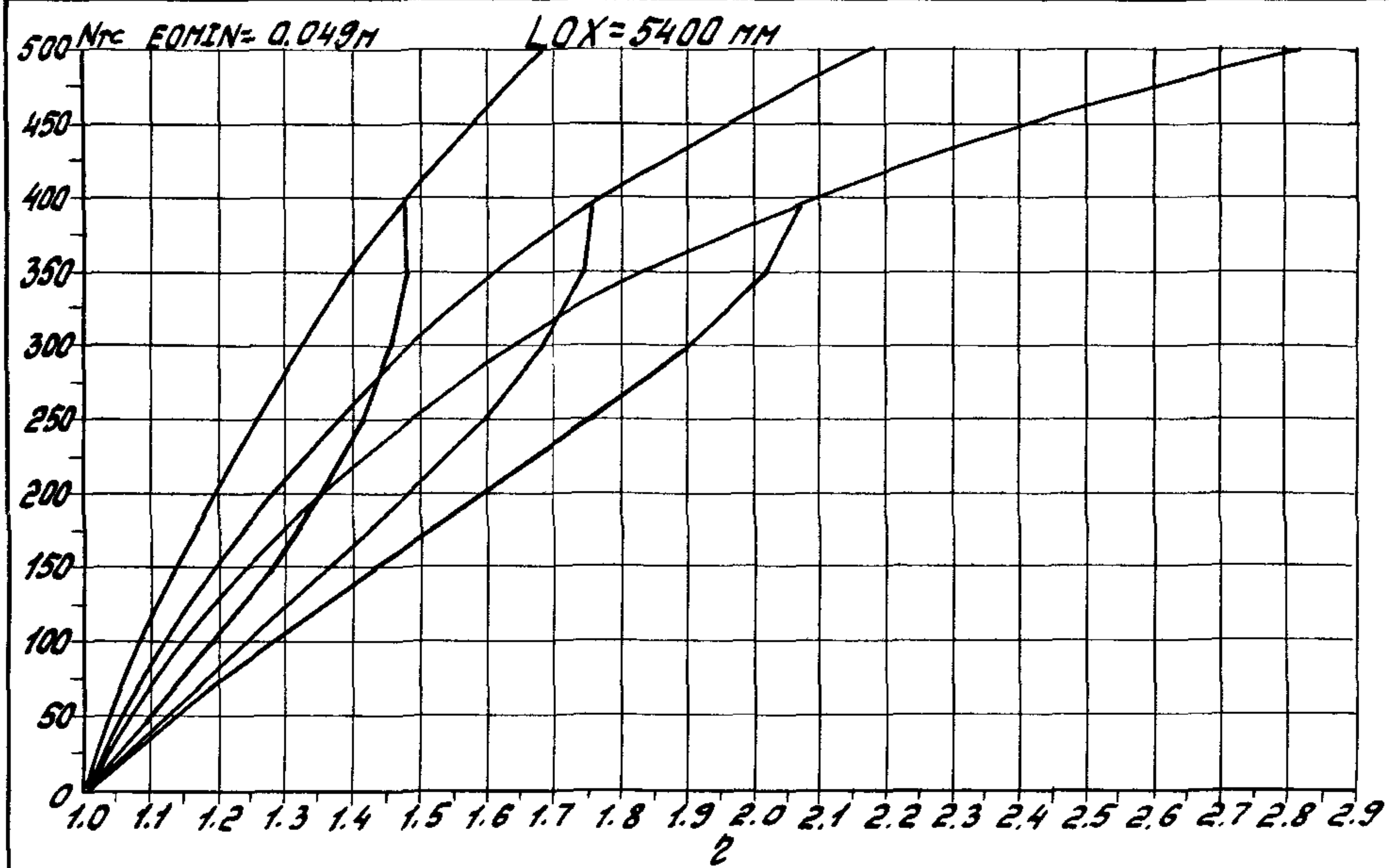

Имя, № подл. Подпись и дата. Взам. инв. №

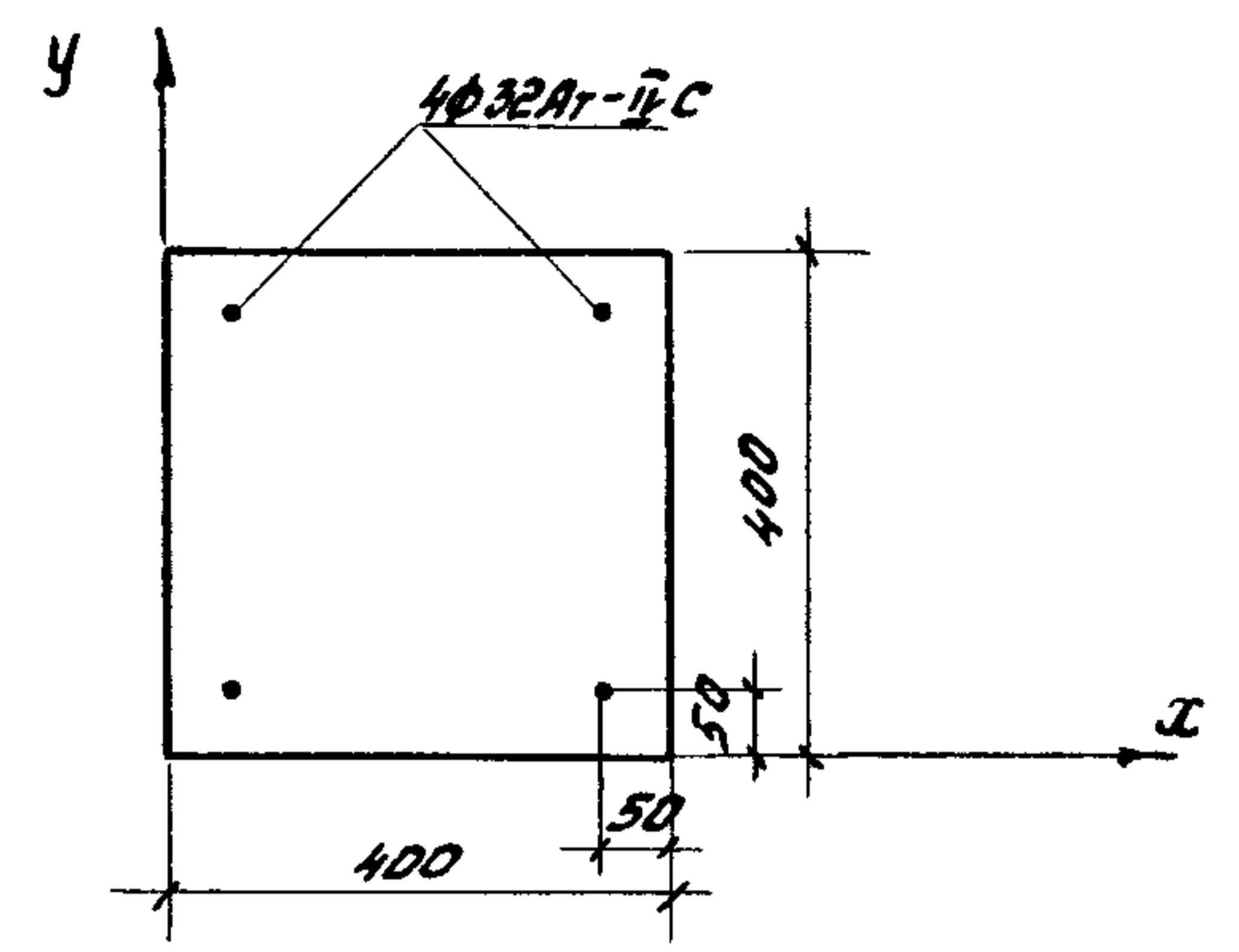

Класс бетона В40 ($R_b = 1,8 \text{ МПа}$ при учёте $\gamma_b = 0,90$)

Сталь А1-IVc

Код сечения -1248

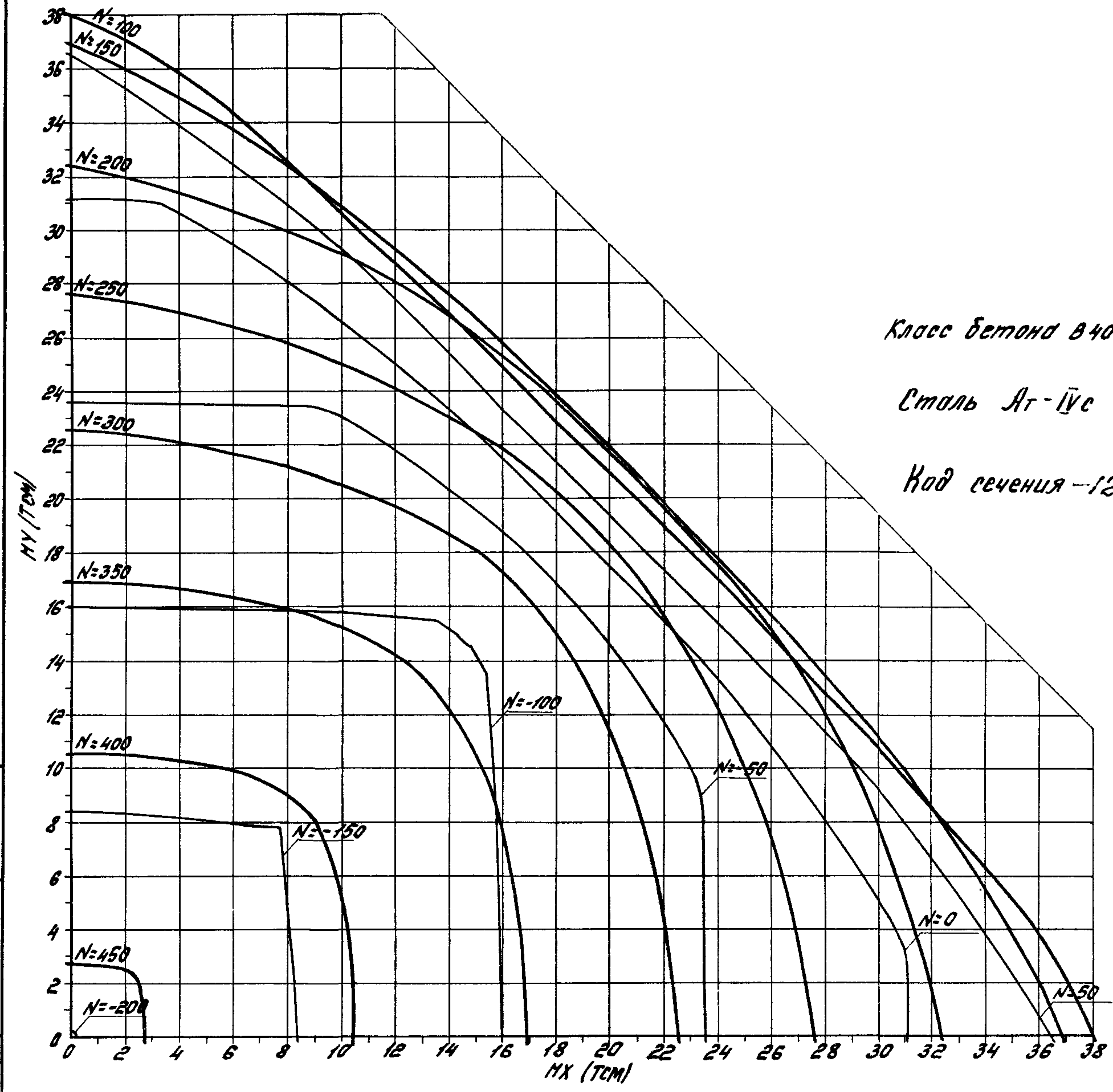

видные в плане (взглянув сверху)

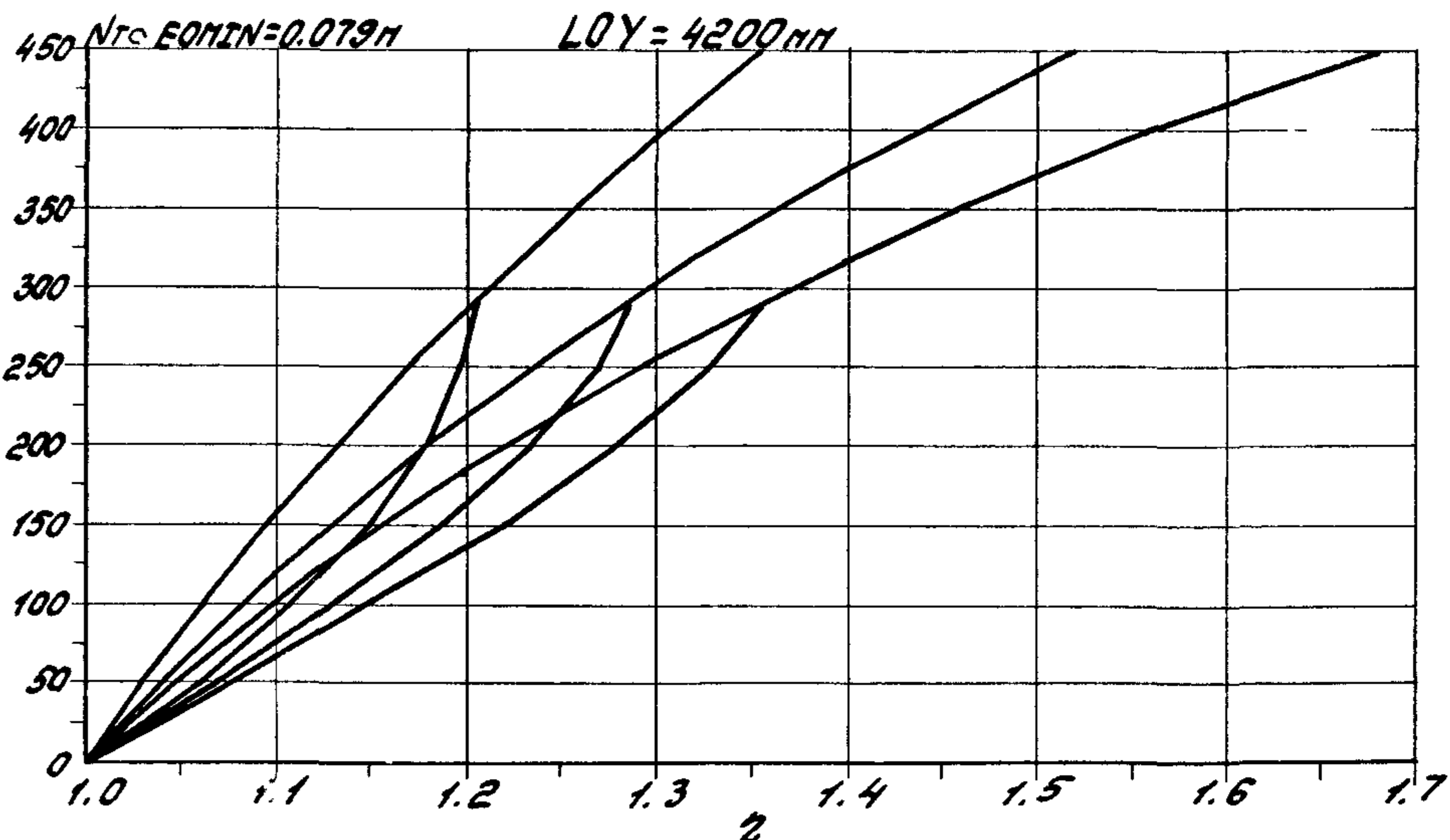
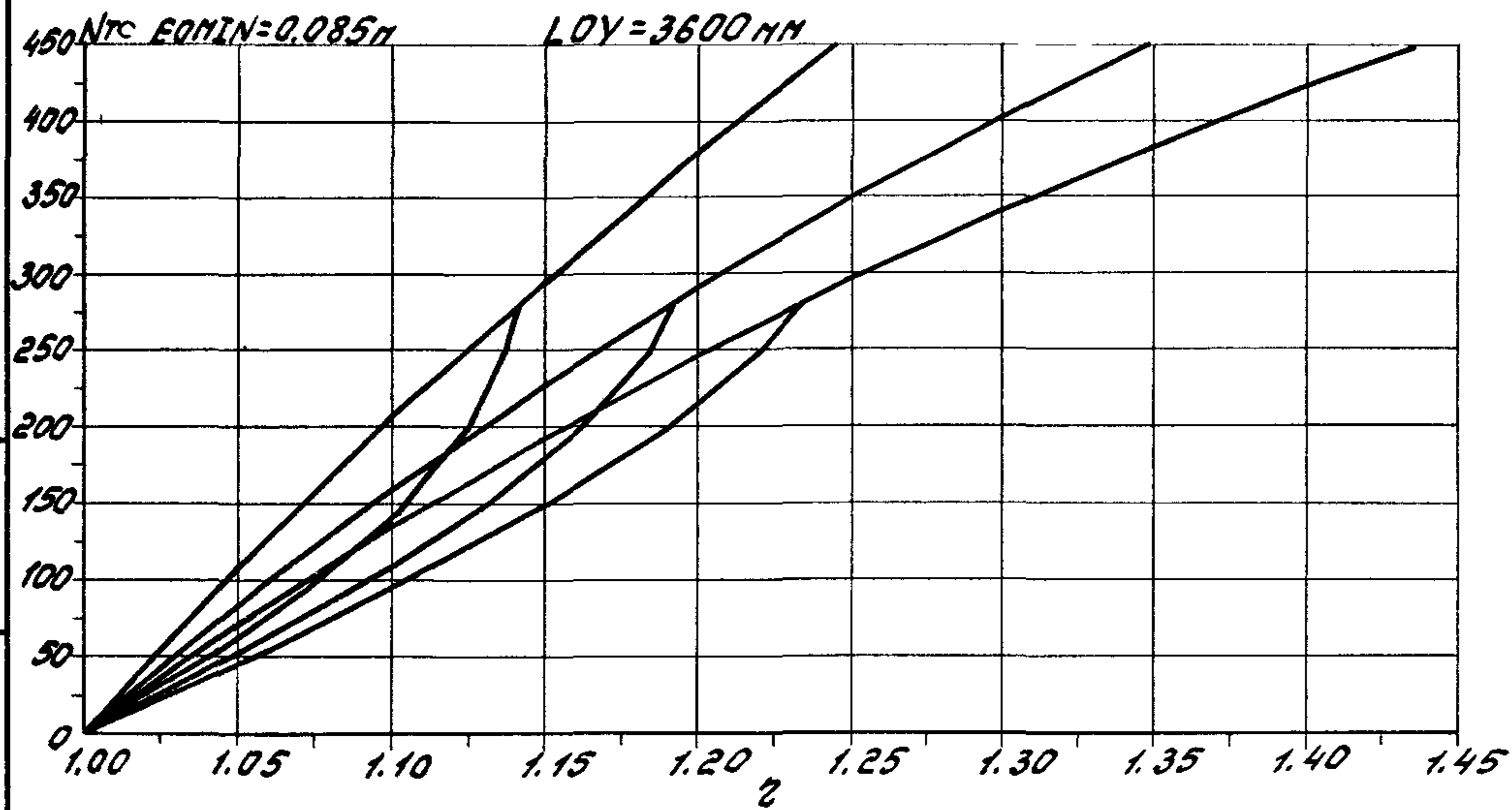
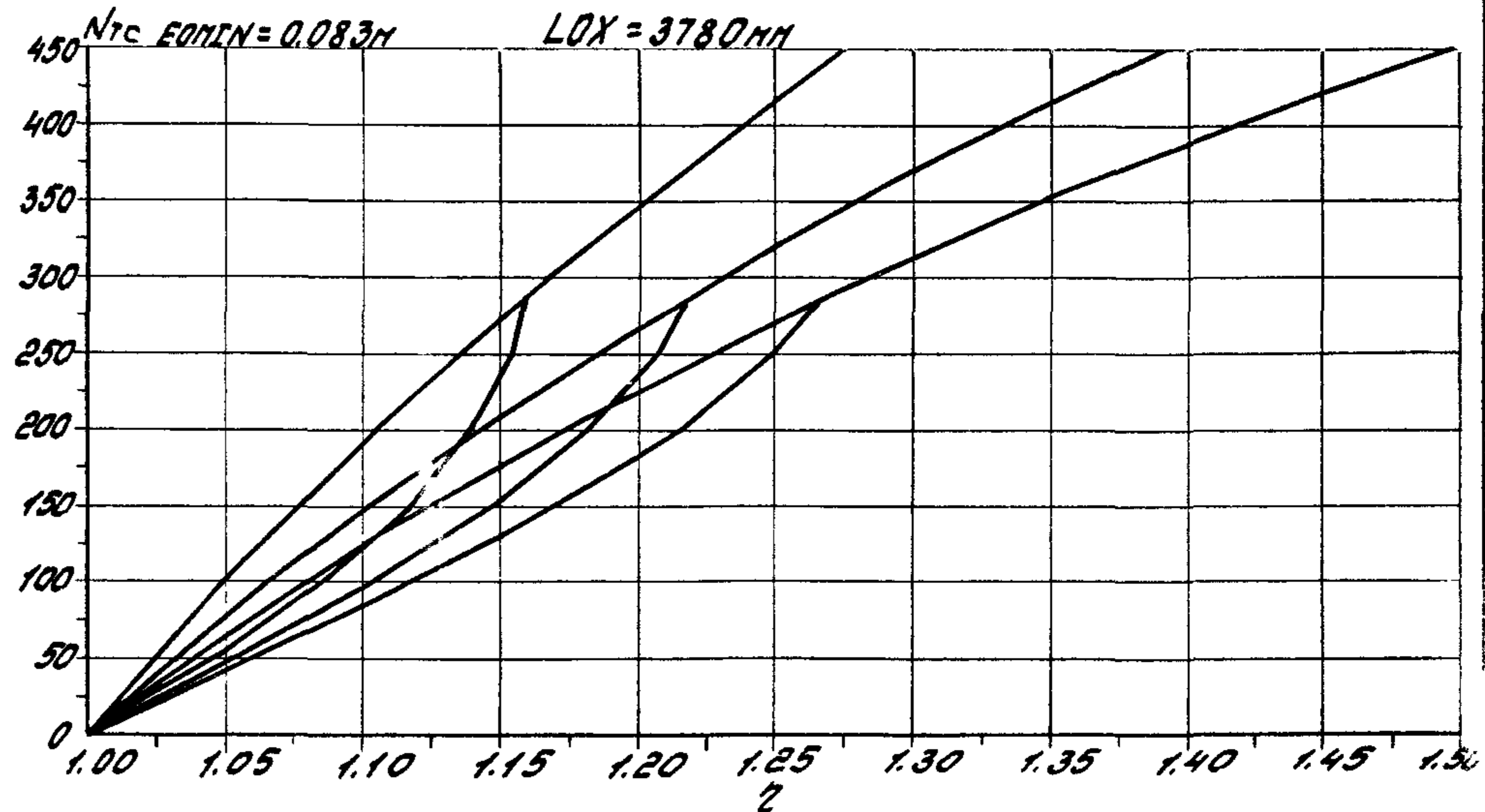
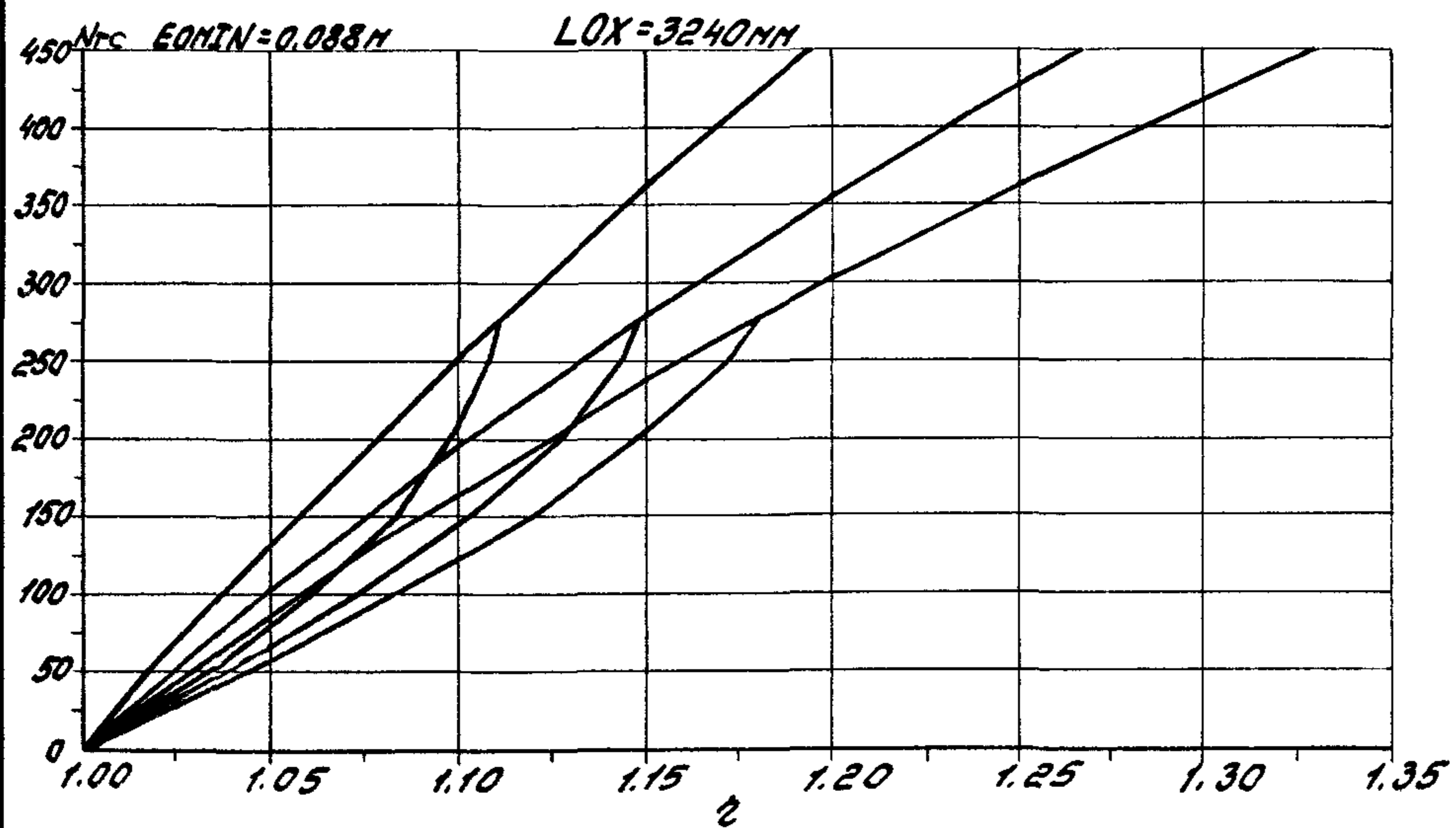

№. №-подл. | Подпись | Дата | Стр. | Итого

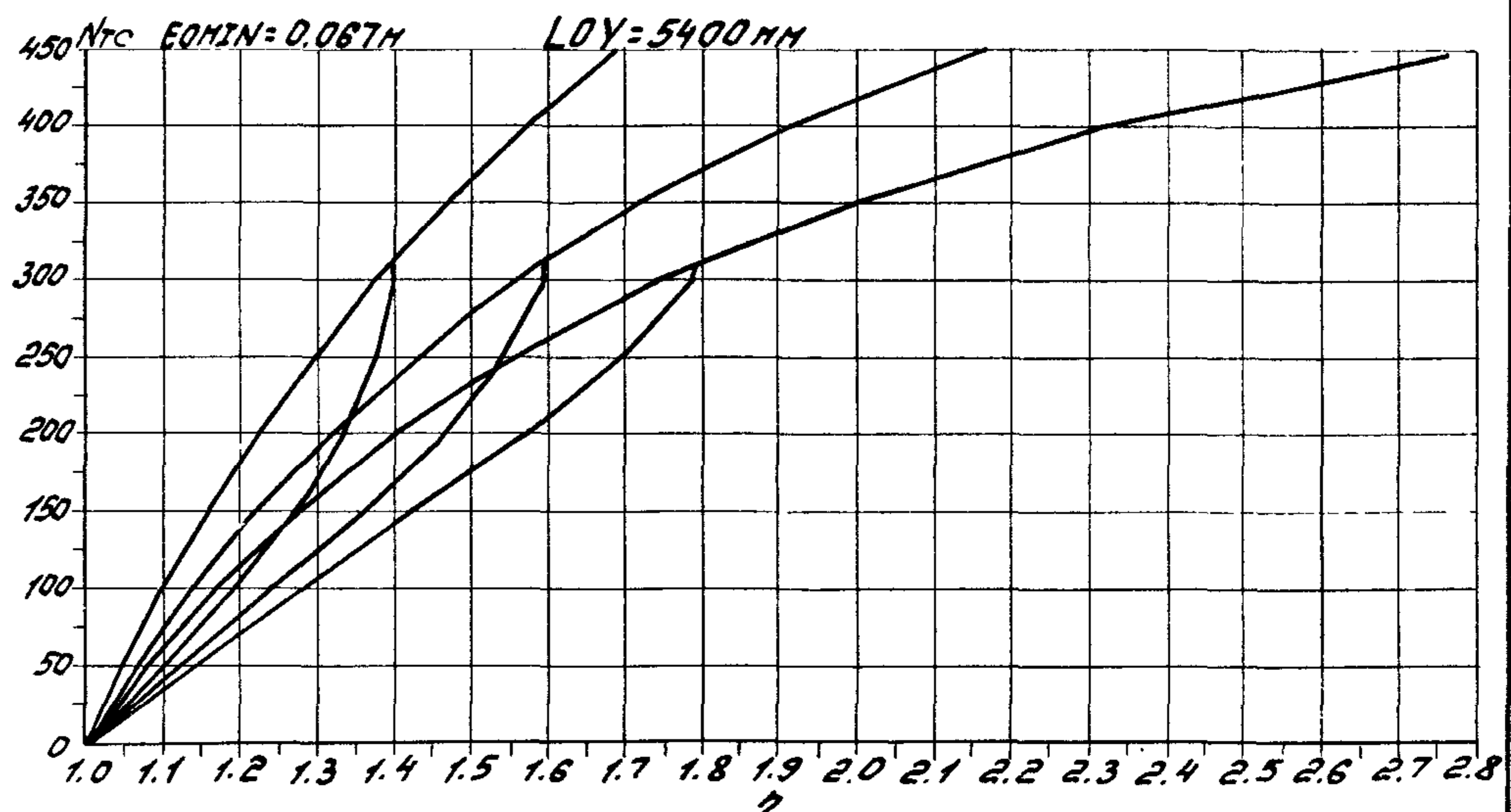
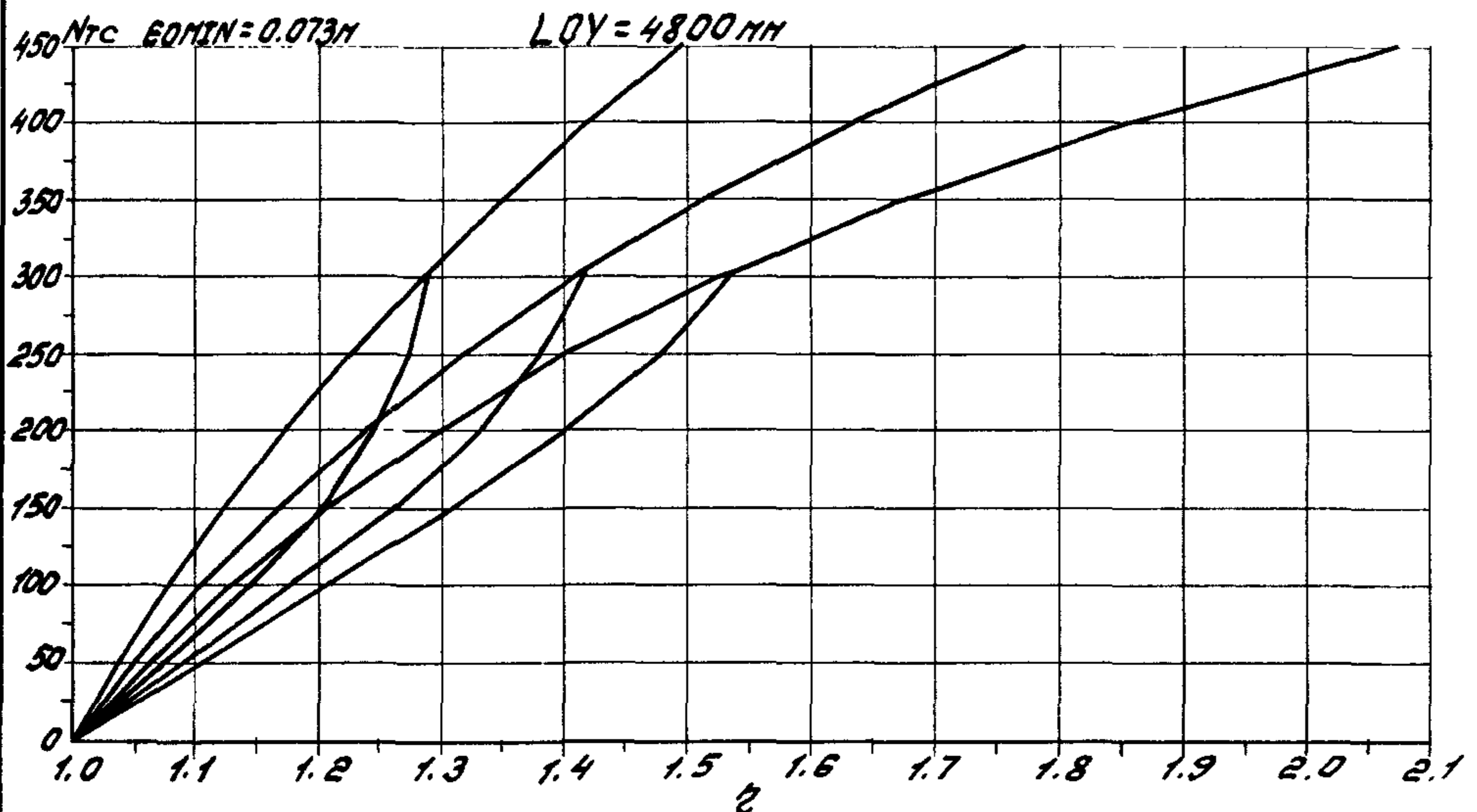
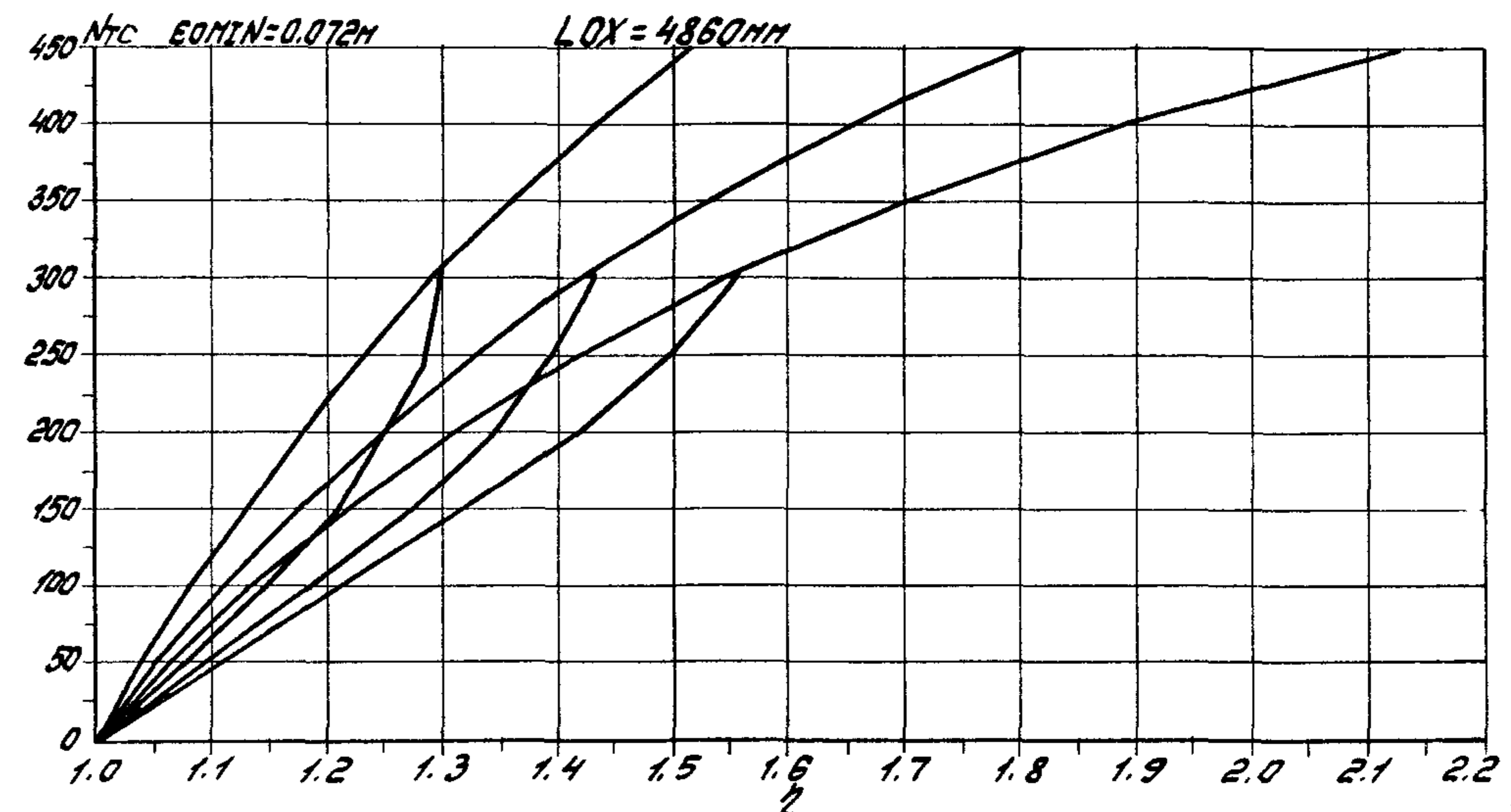
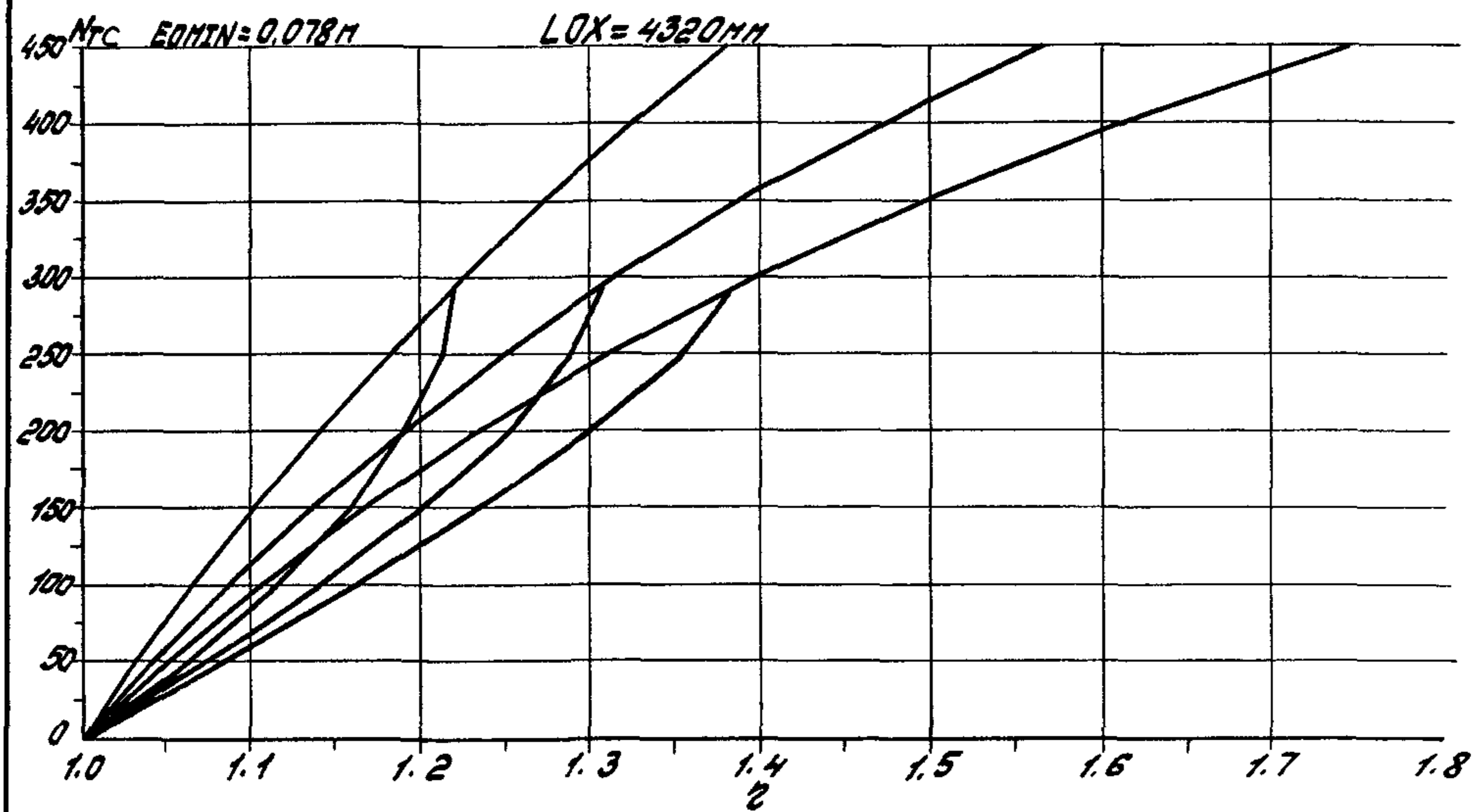

Инв. № 1000/1. Счетчик в ДДМО 8301.016.02

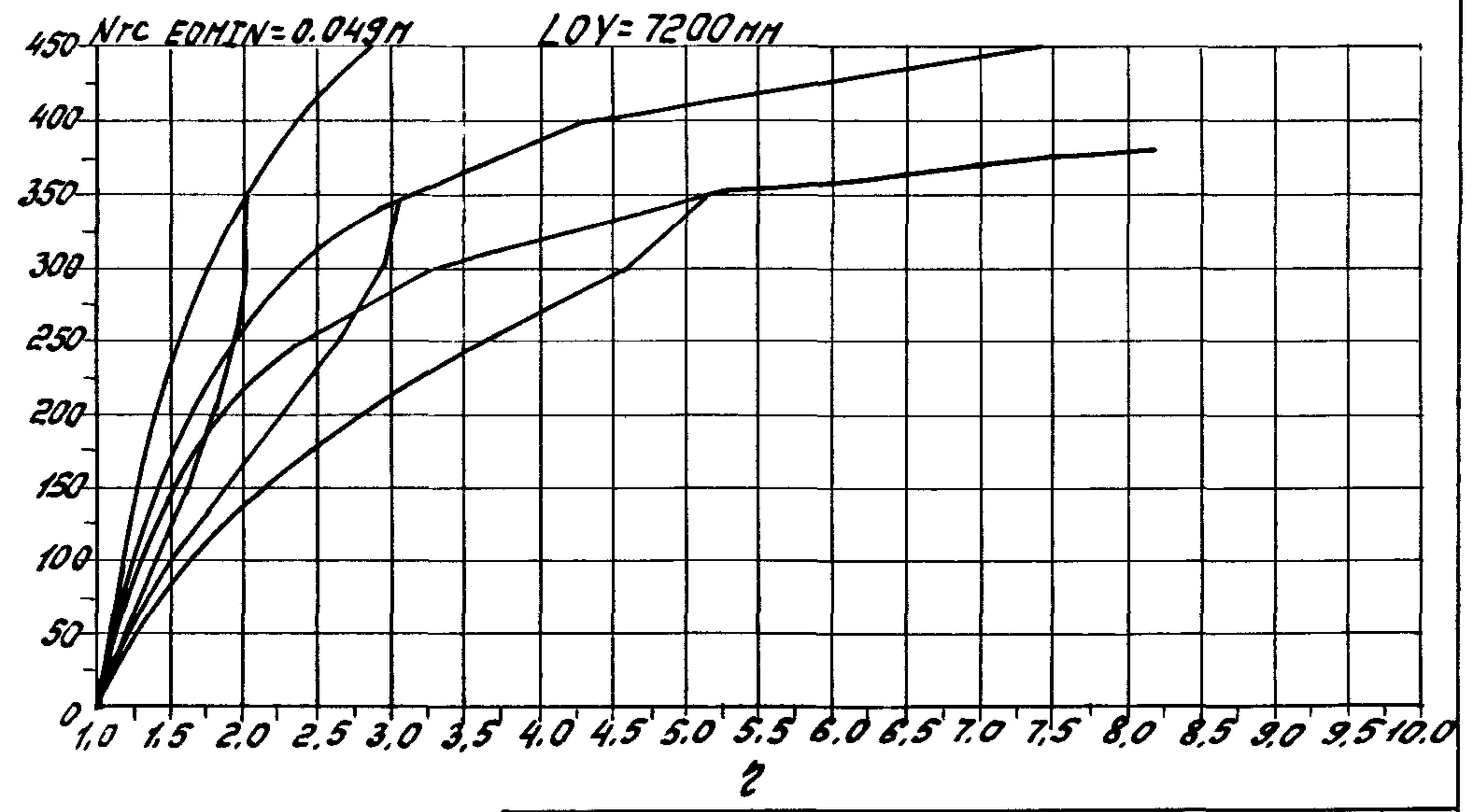
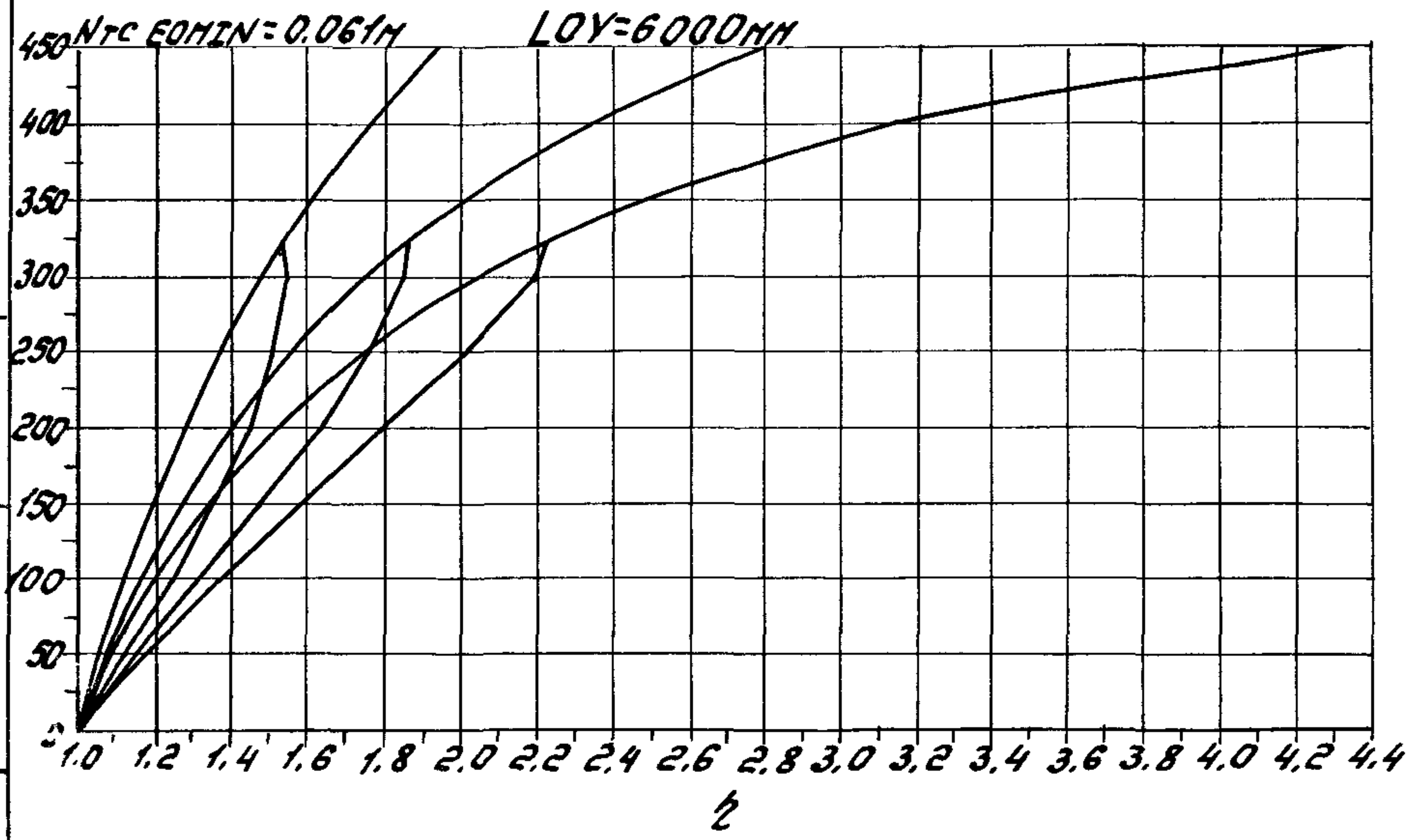
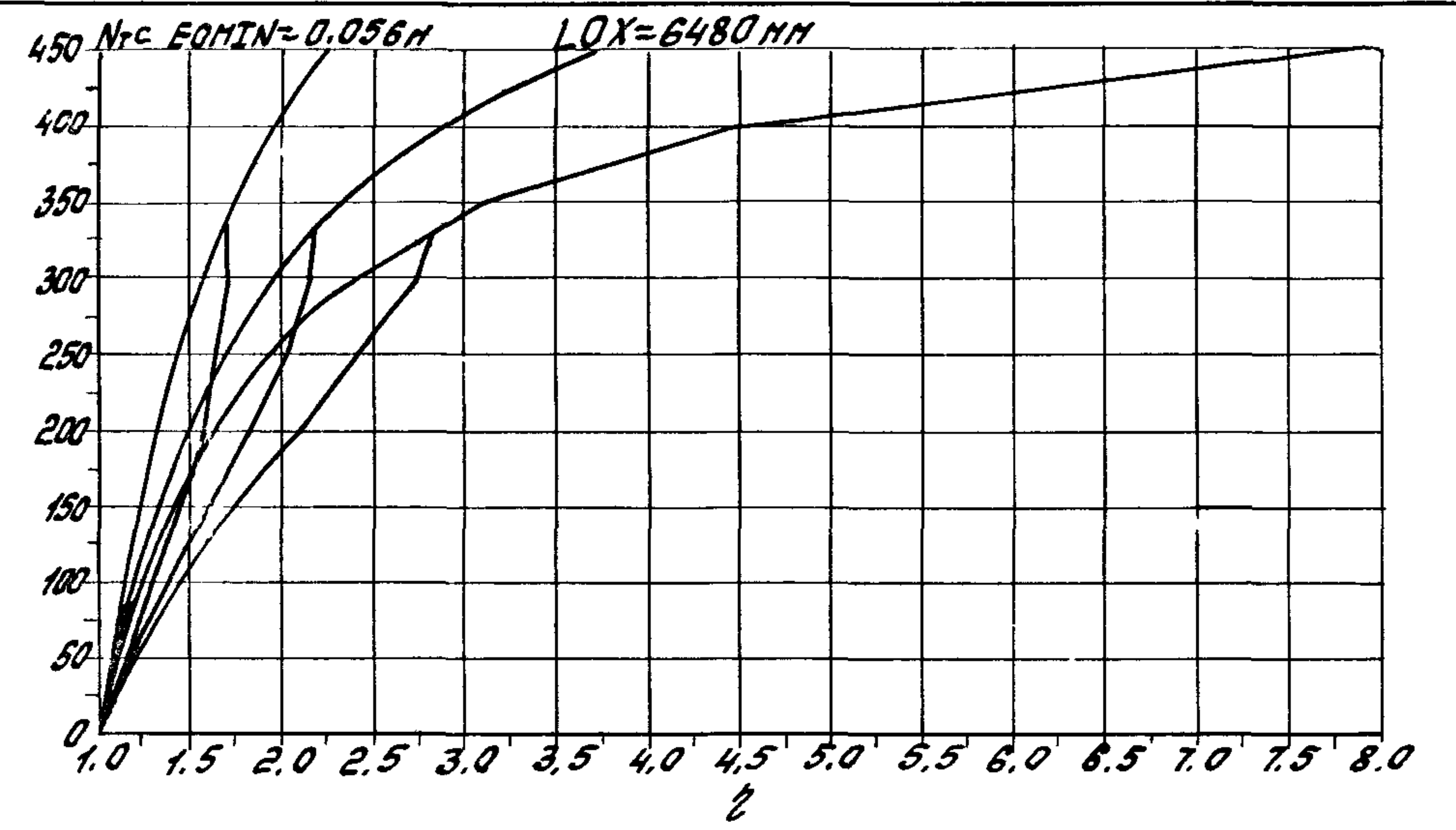
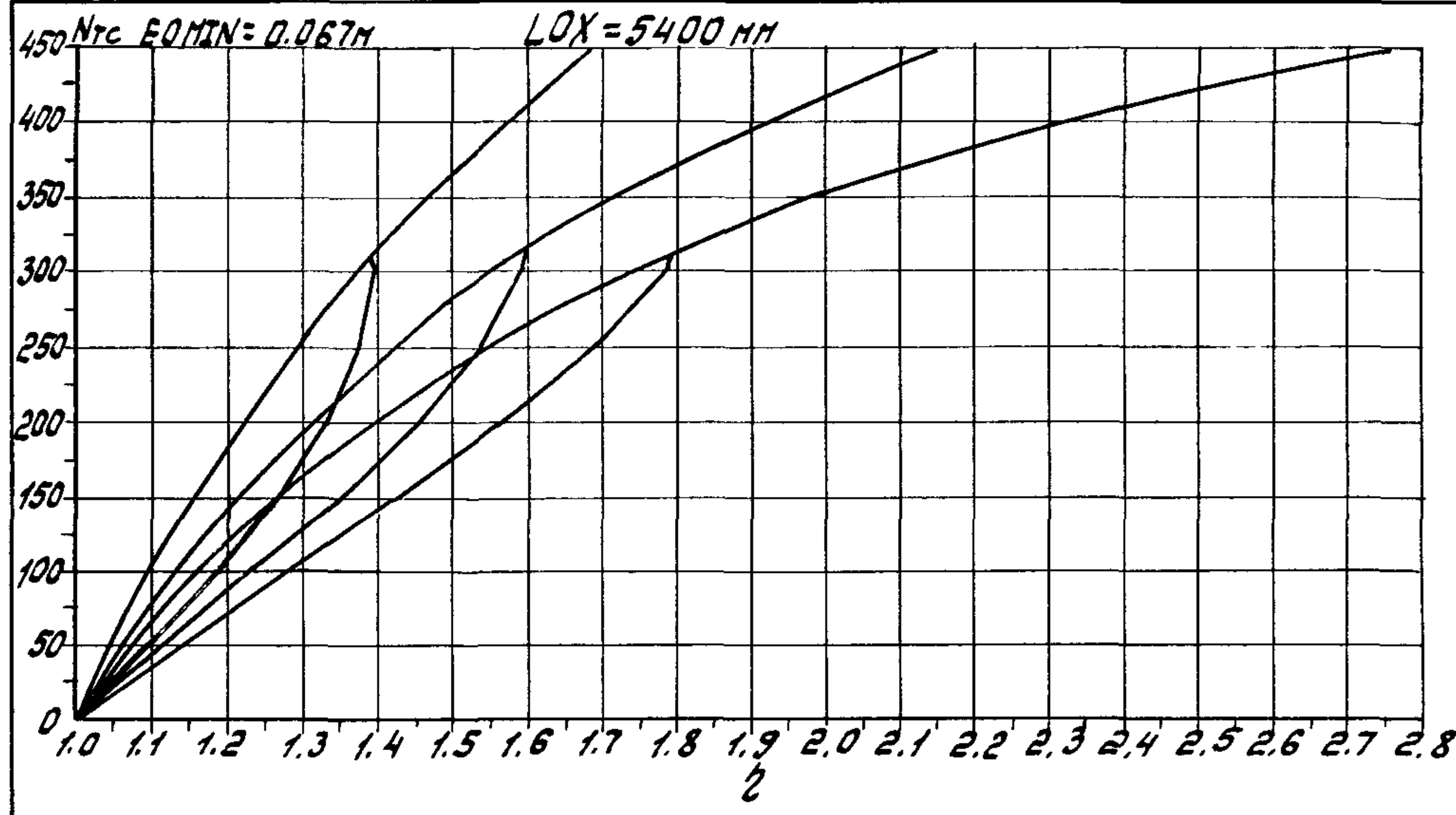

Умб. Нлода Платисъ и Вота Взам. Умб. Н

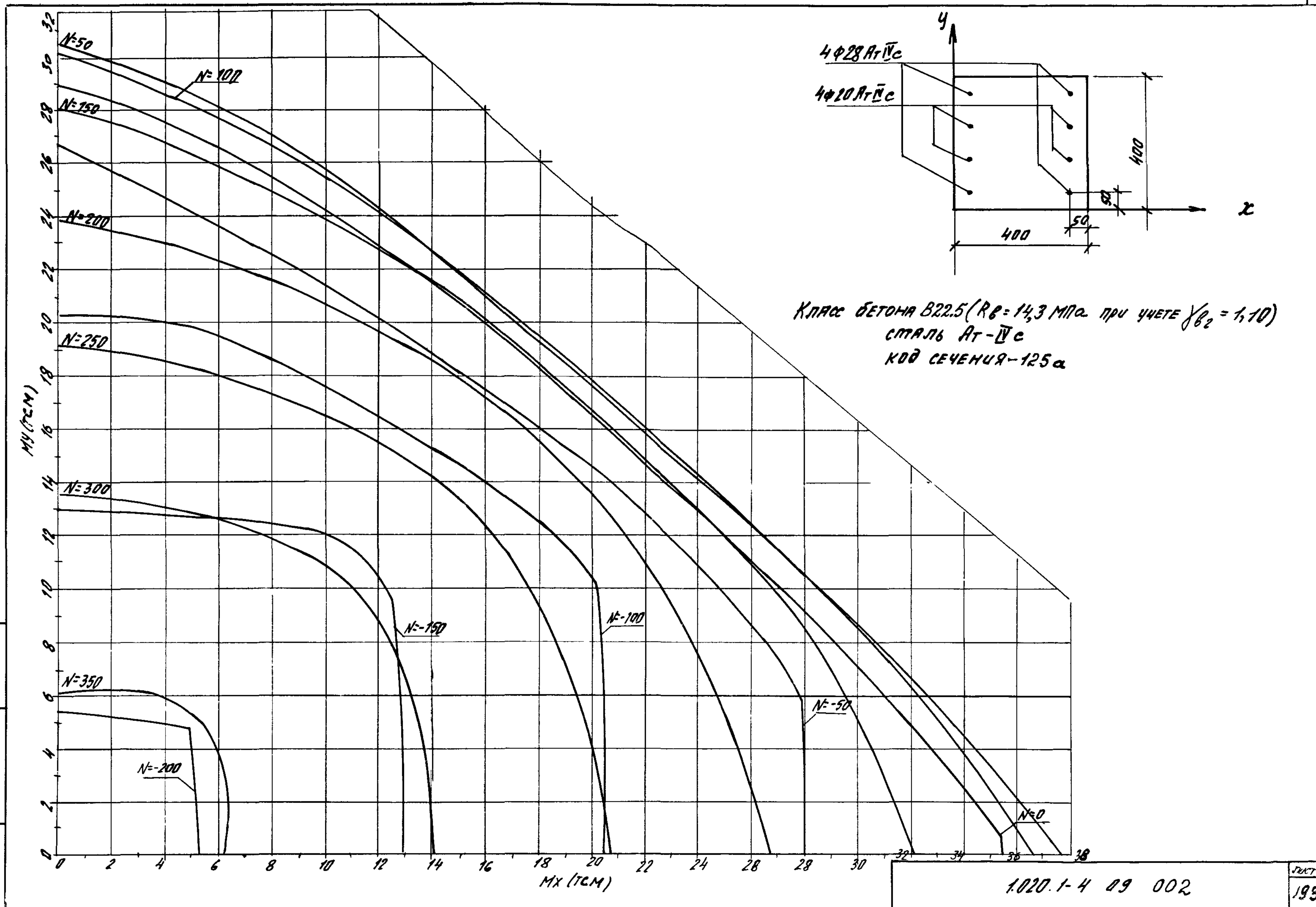

ДАТА ВЪВЕДЕНИЯ

1.020.1-4 09 002

ЛИСТ
193

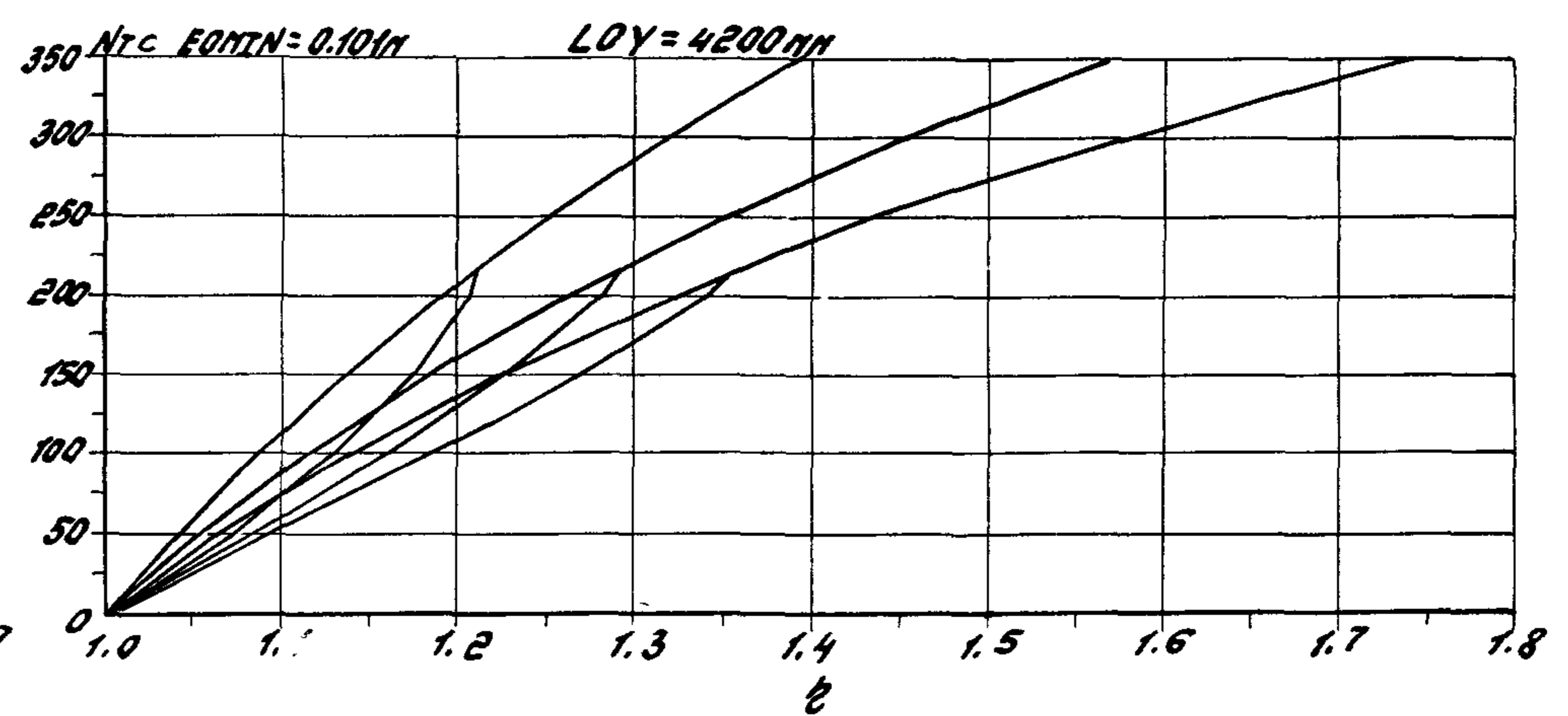
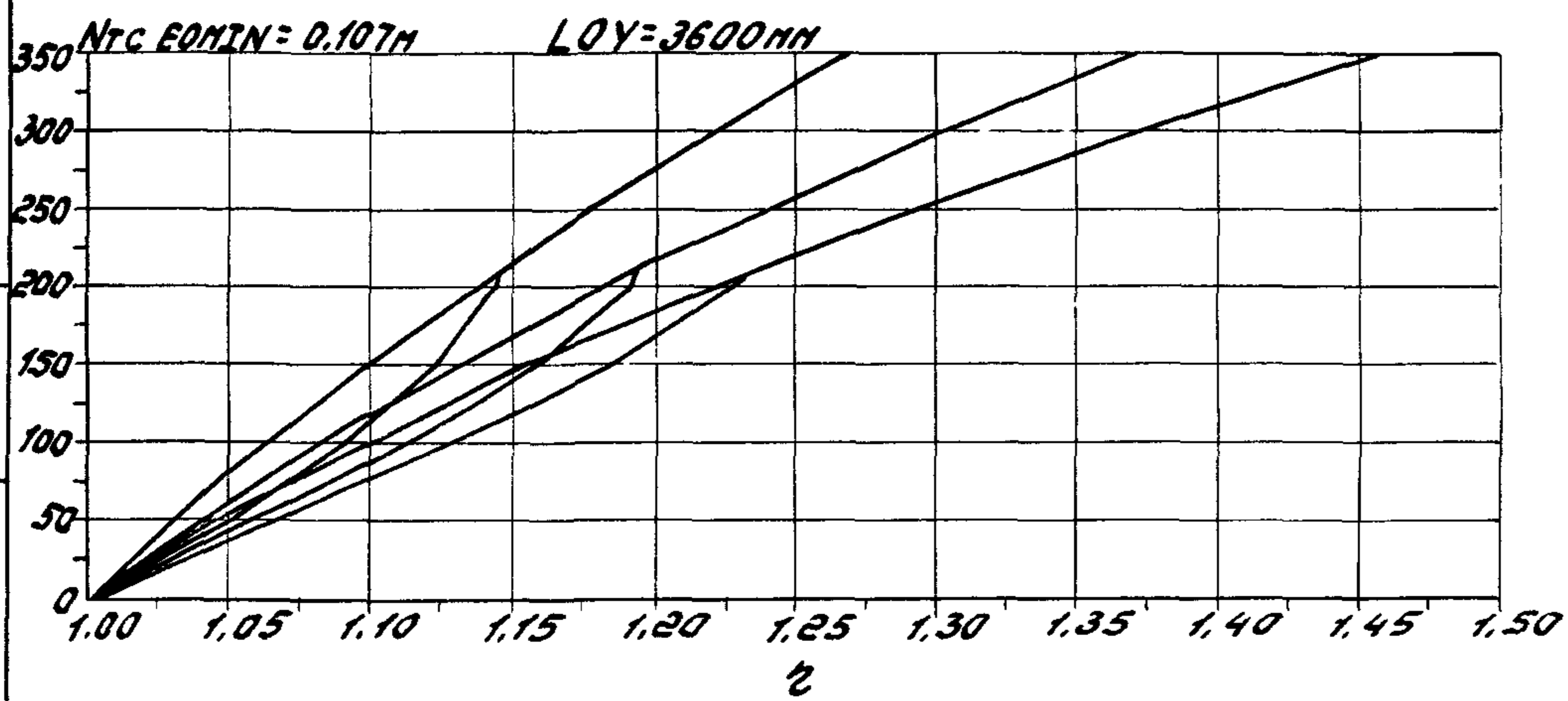
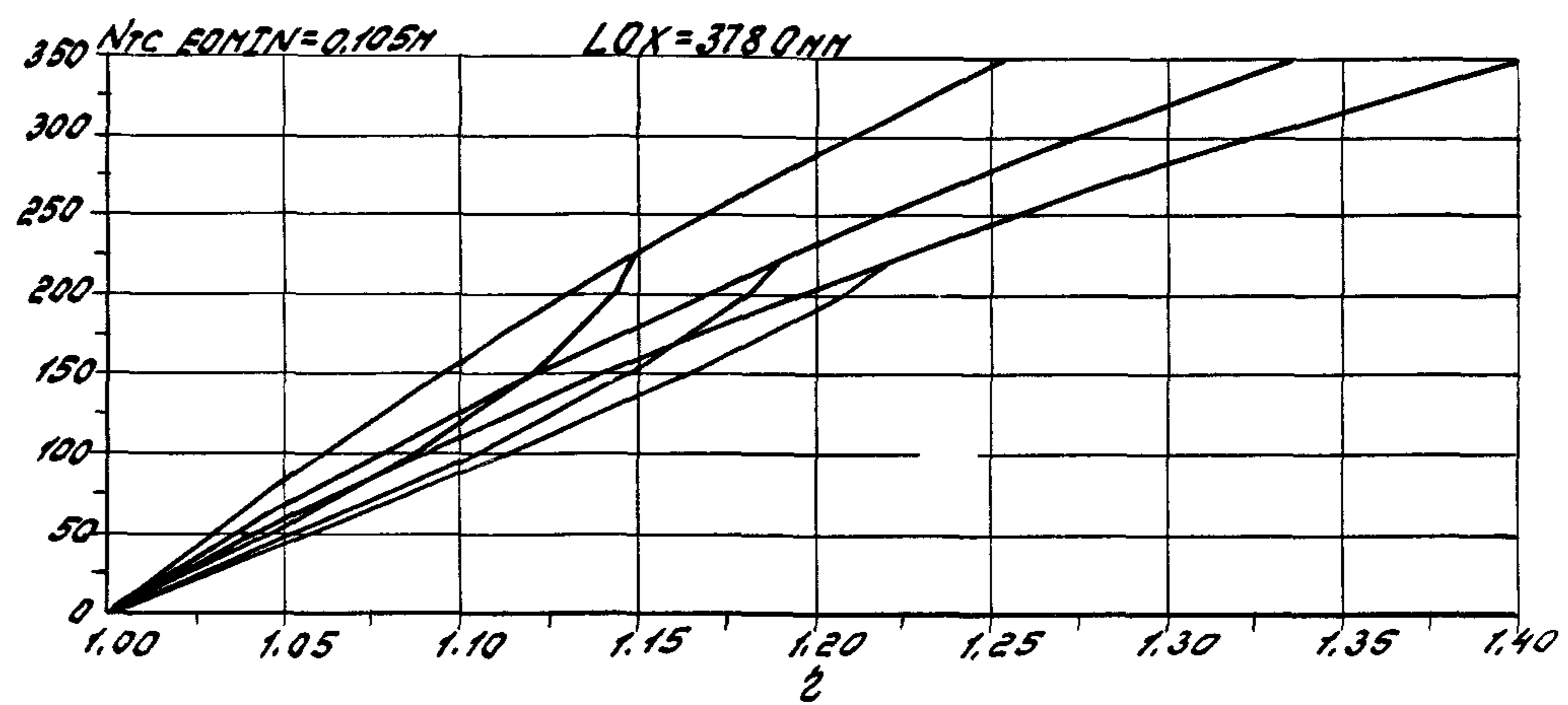
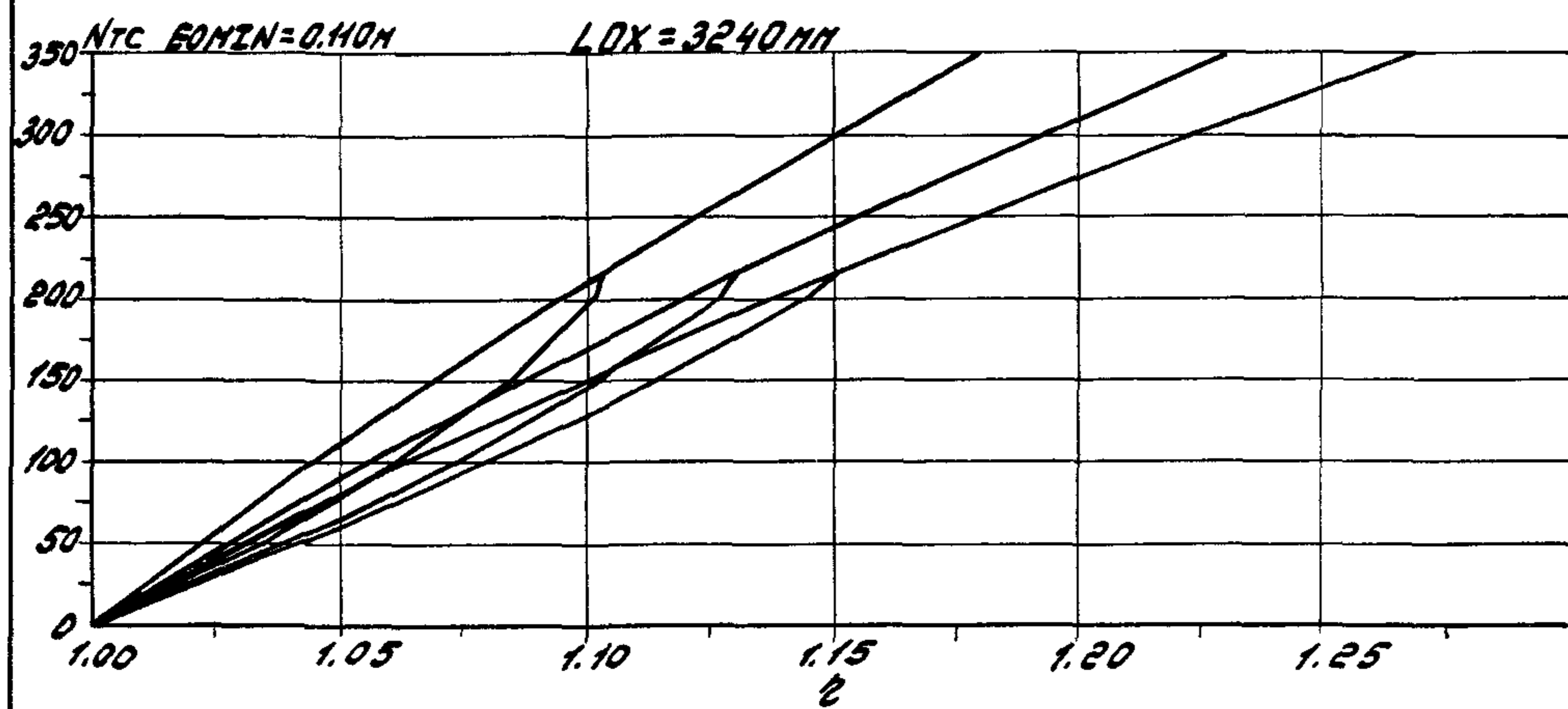

Учб. N. 1020.1-4 0-9 002

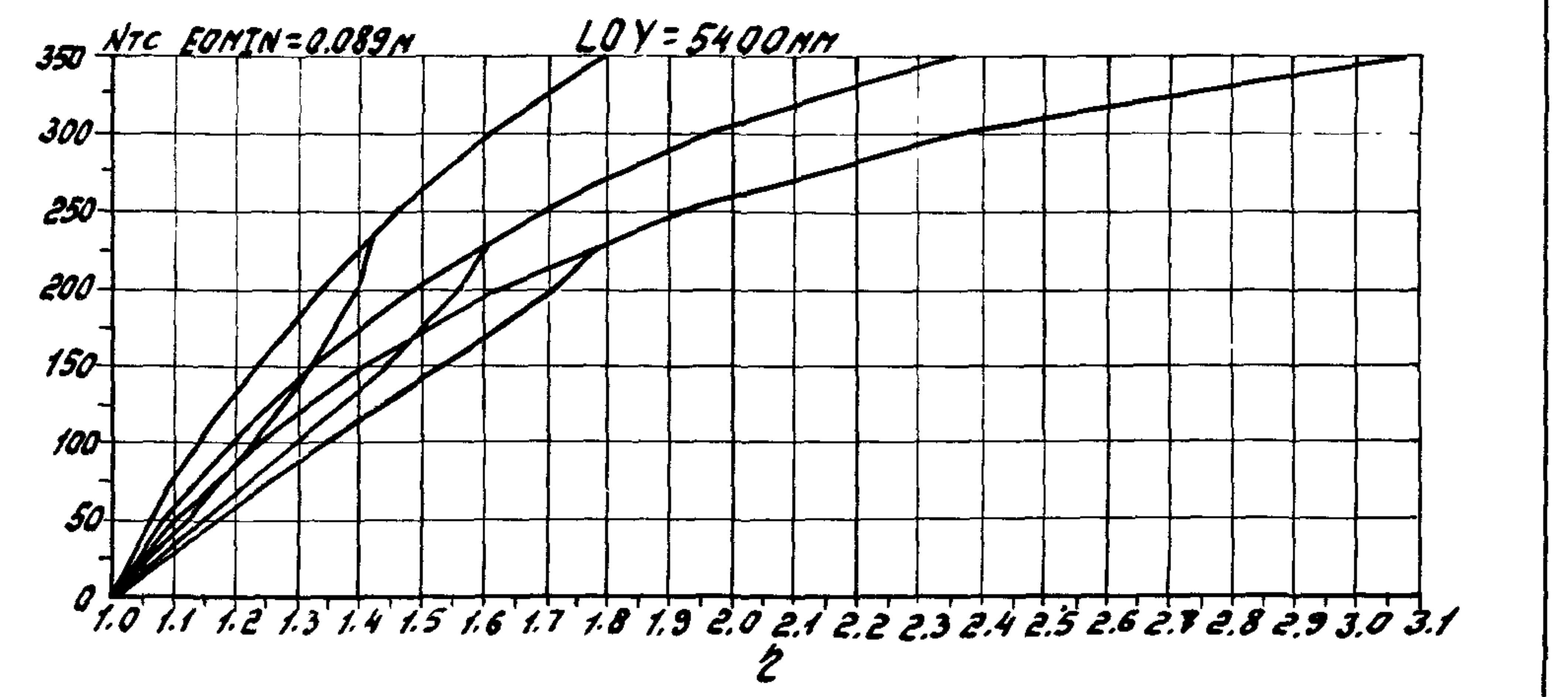
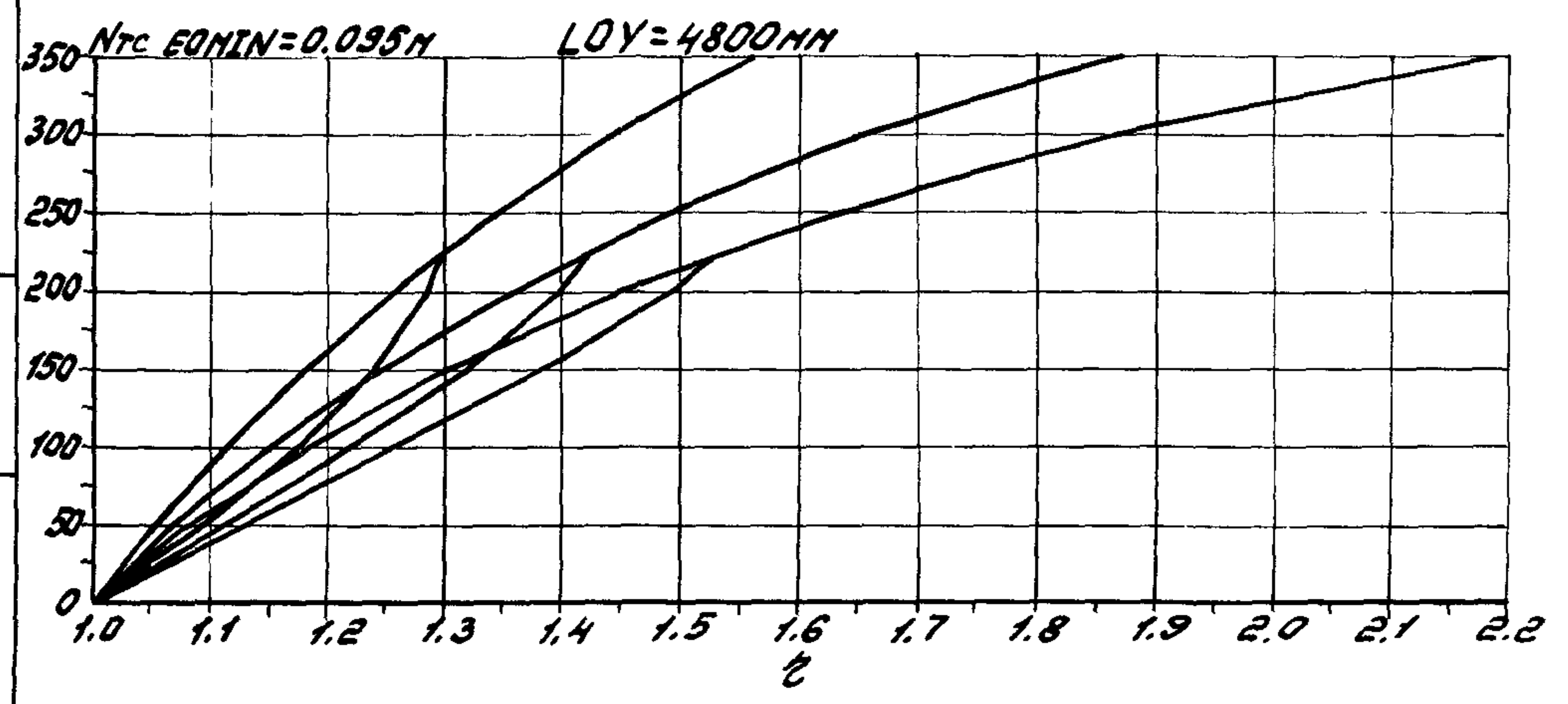
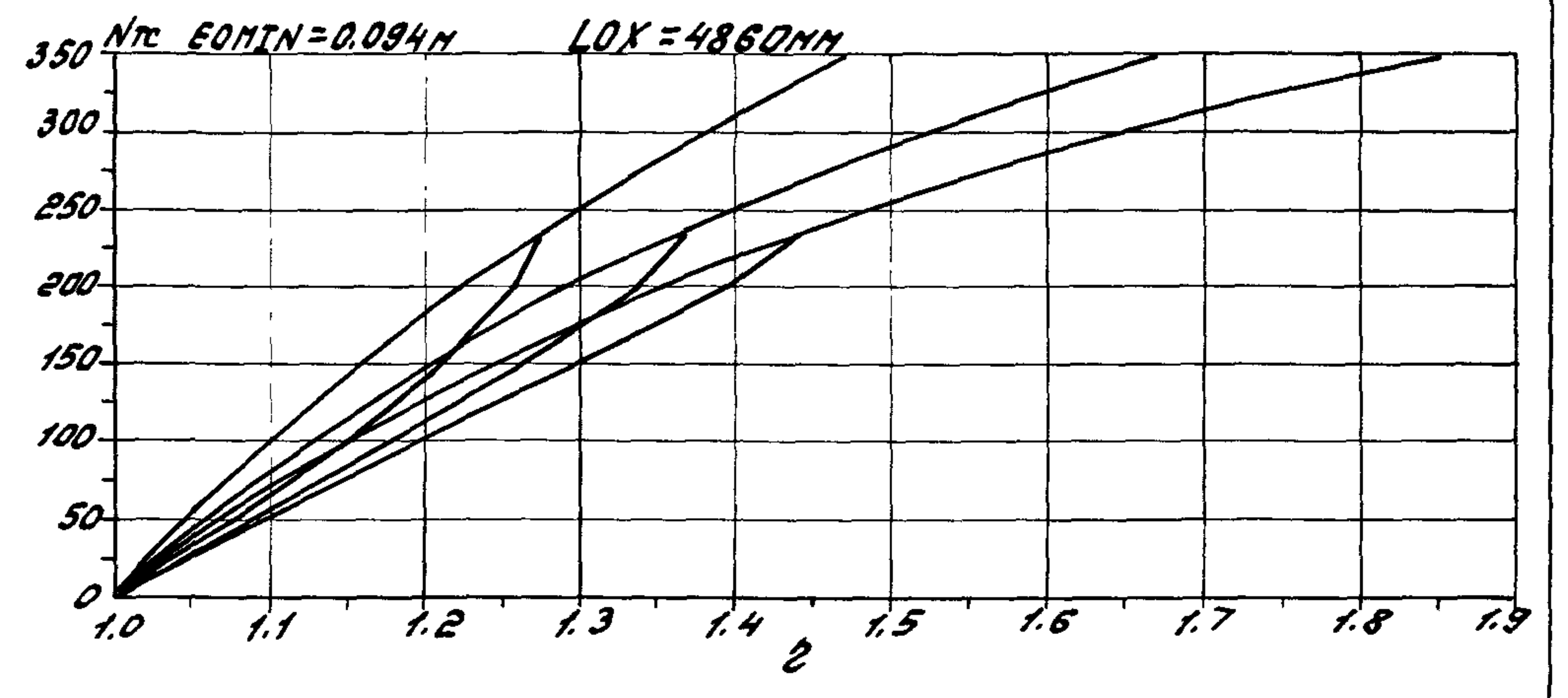
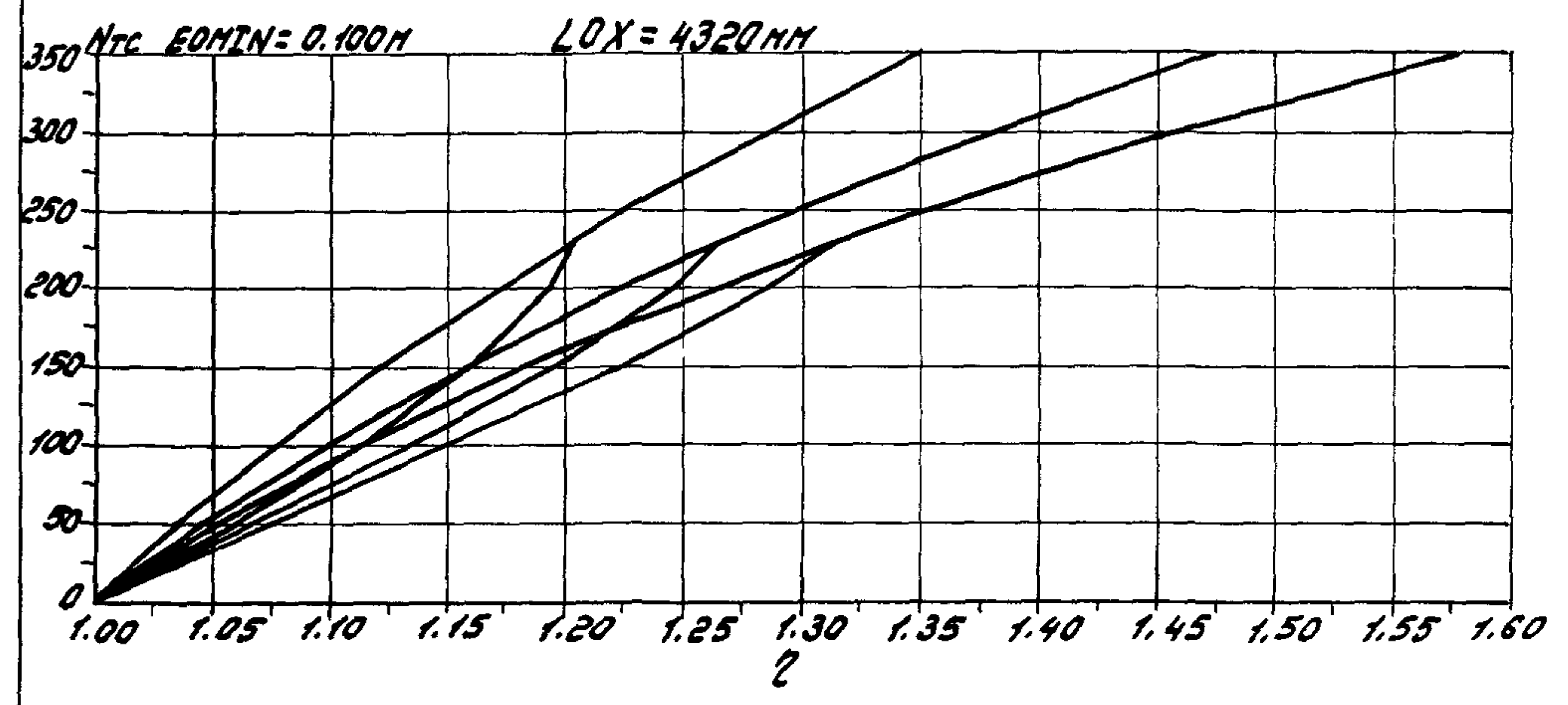

C6 UDUIM
UNB. N/No.

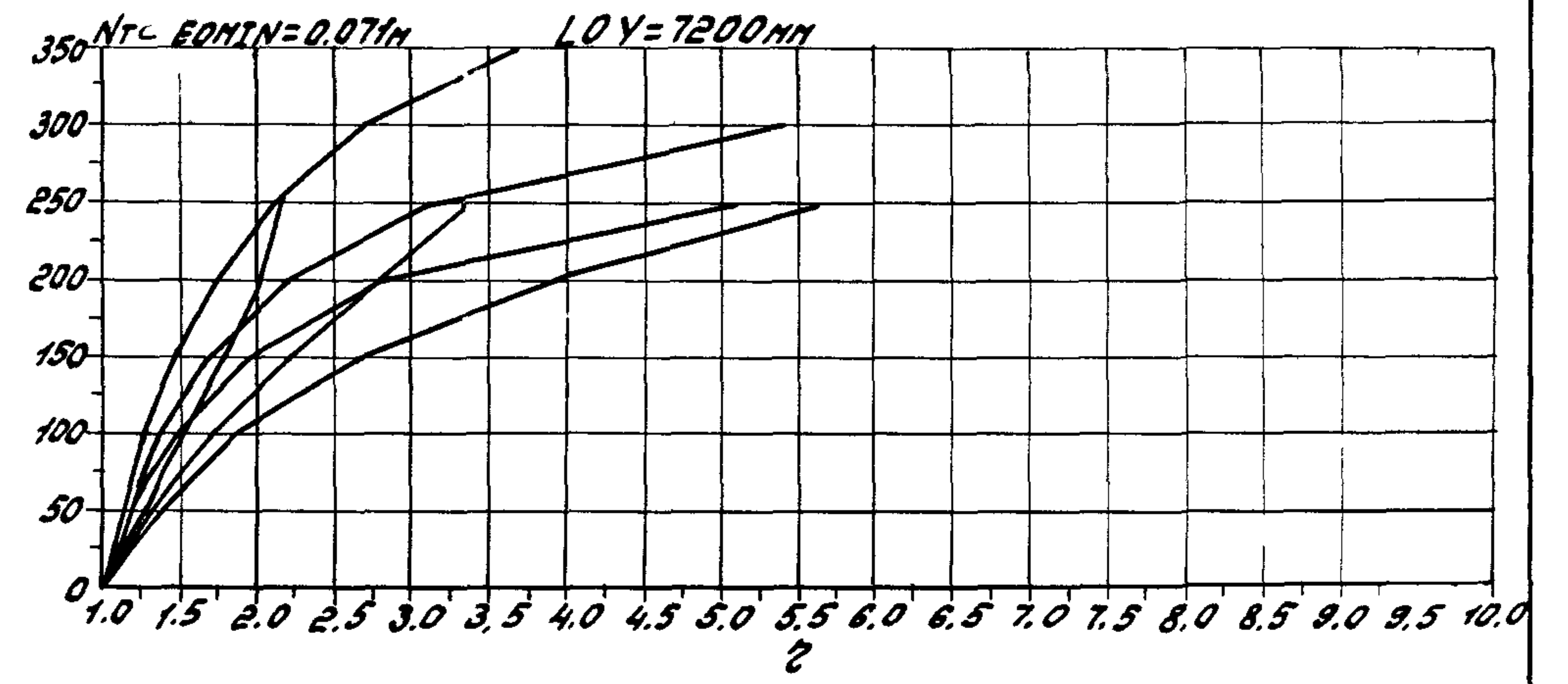
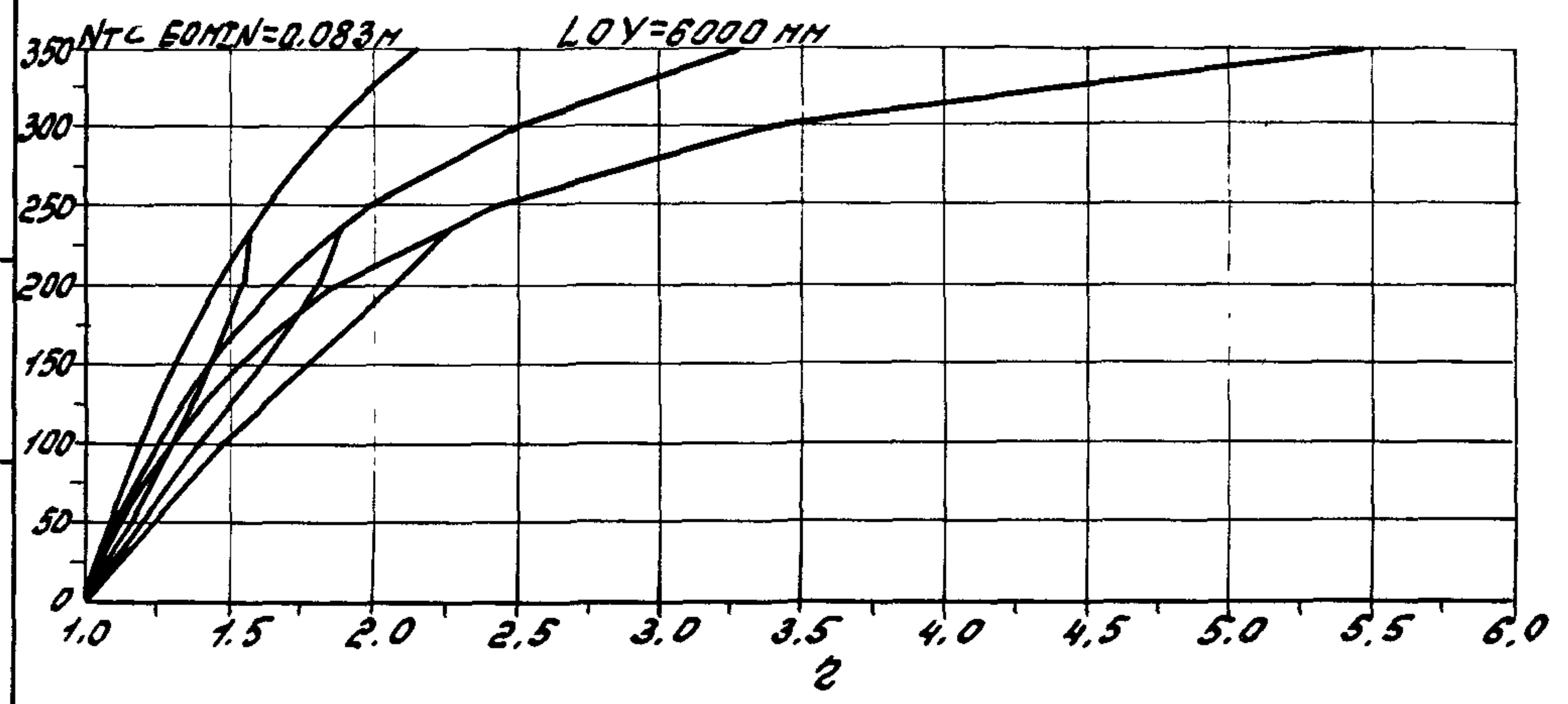
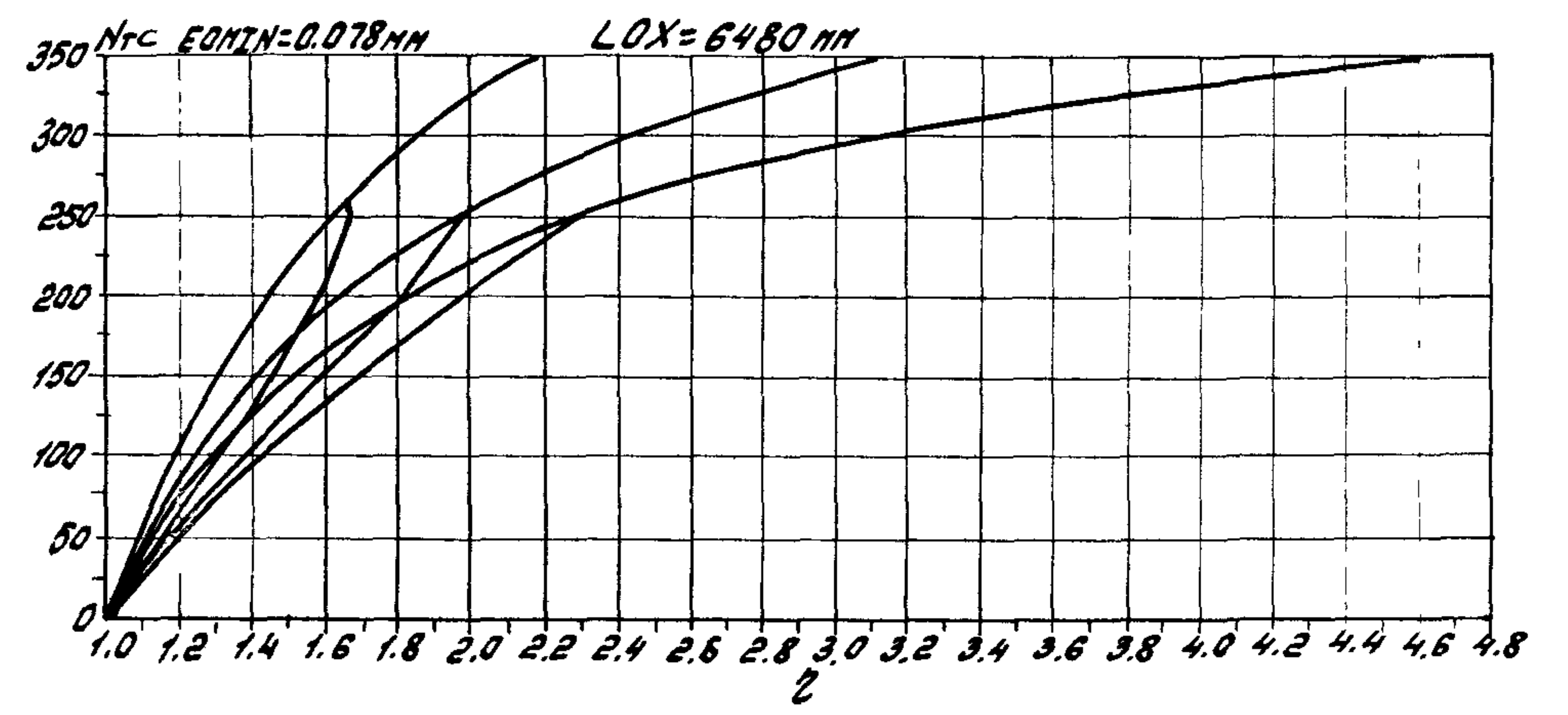
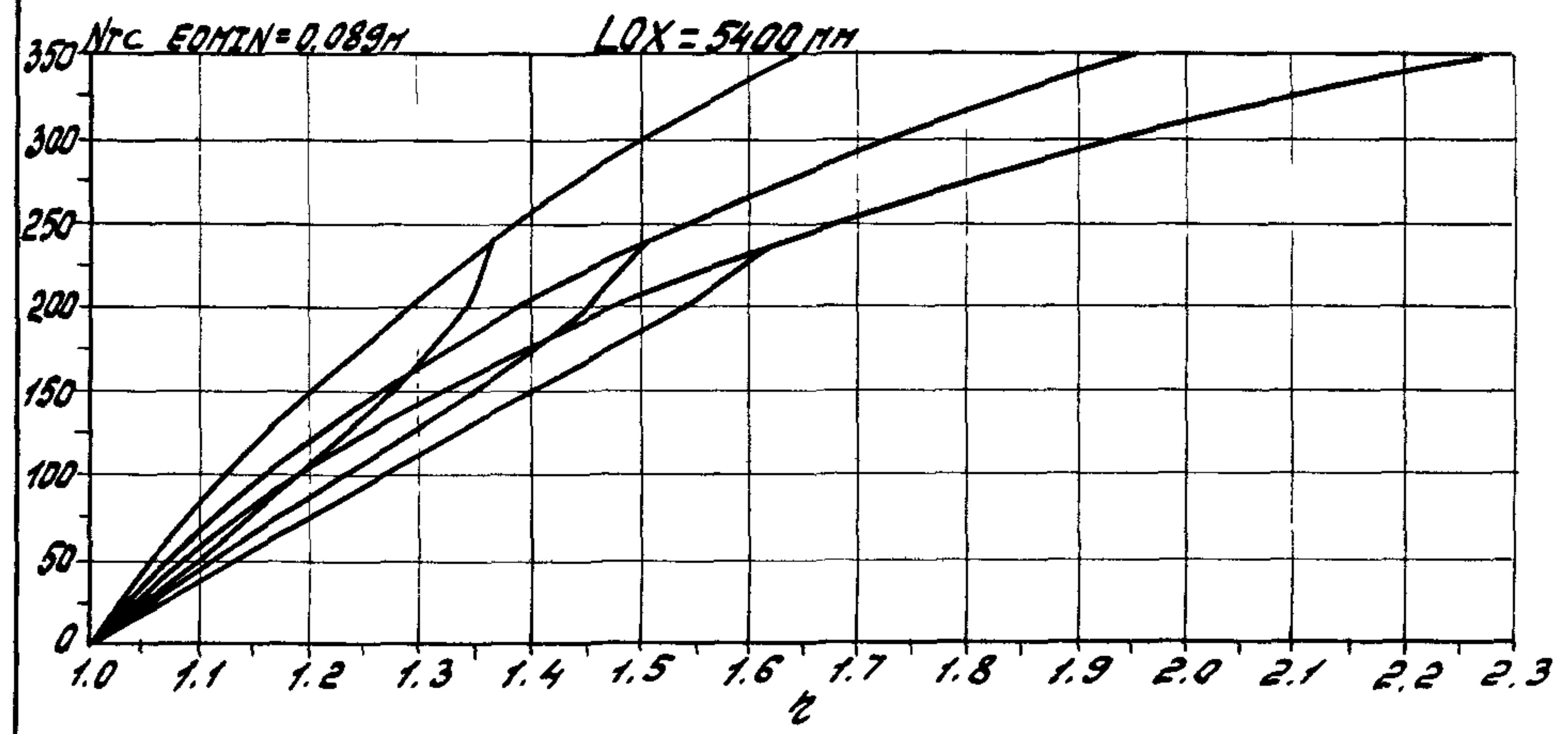

Шиб. N лодки. Подпись и дата. Взам. инв. N

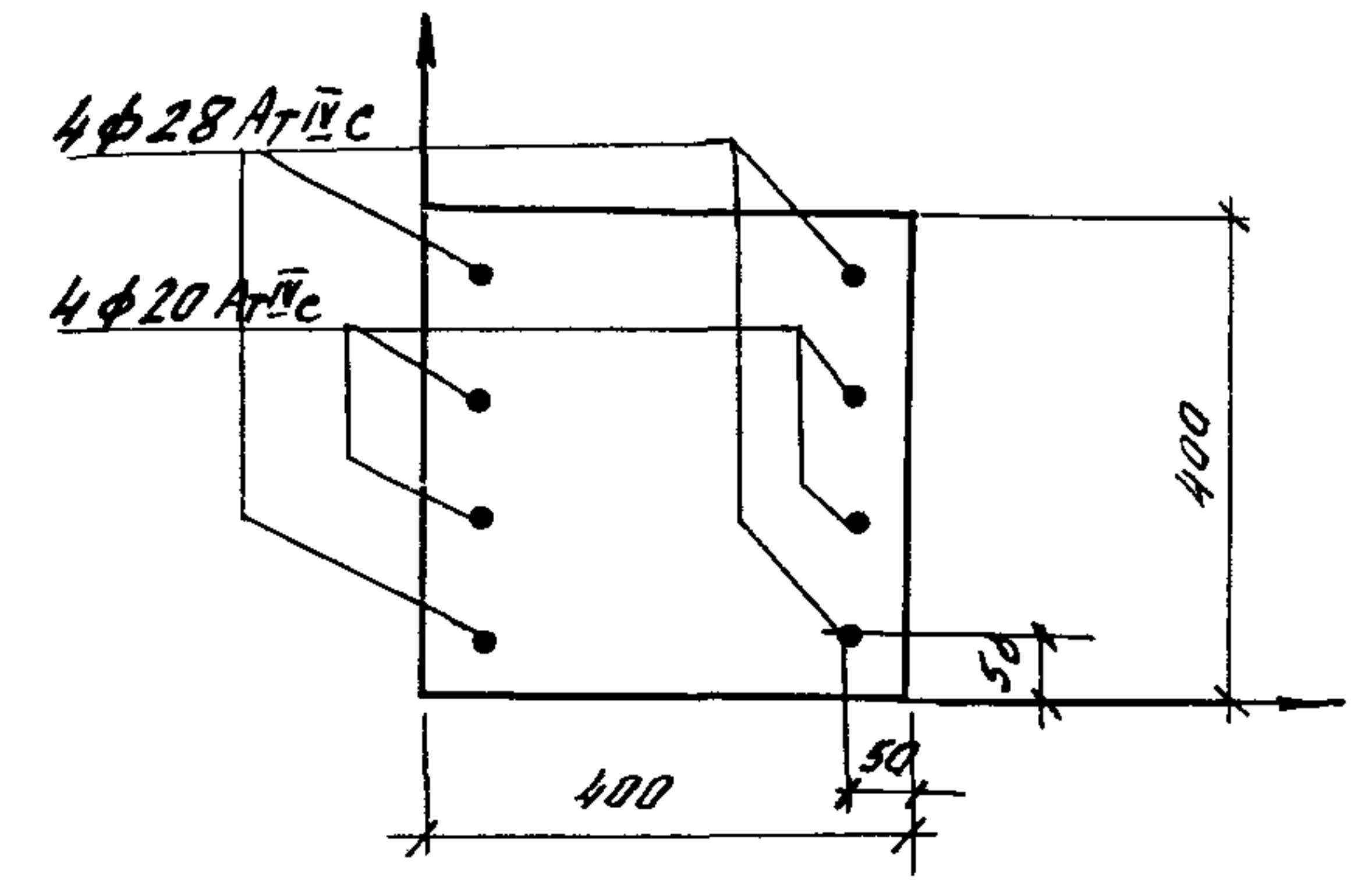
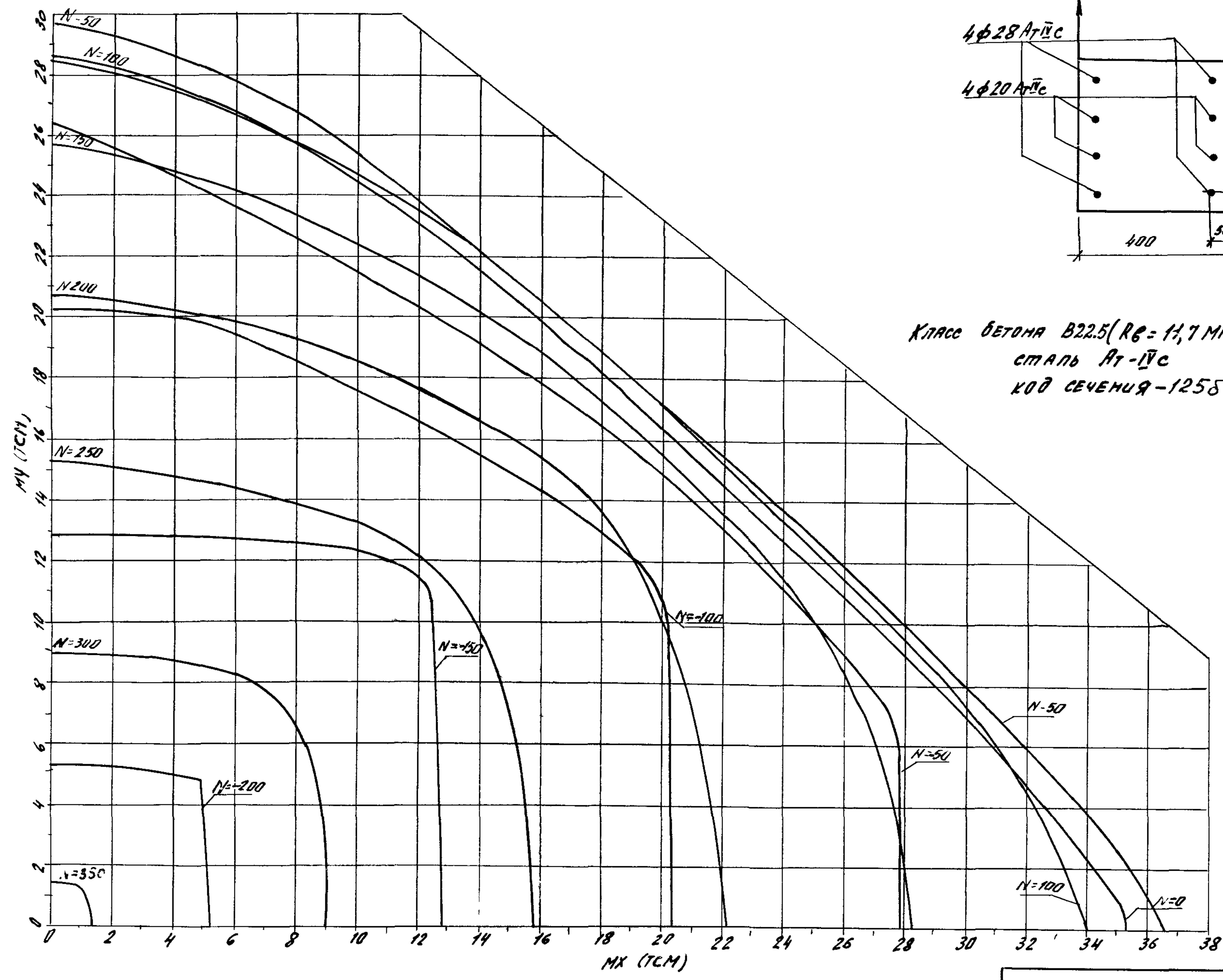

КЛАСС БЕТОНА В22.5 ($R_b = 11,7$ МПа при учете $\gamma_{b2} = 0,90$)
 СТАЛЬ АТ-IIC
 КОД СЕЧЕНИЯ - 1258

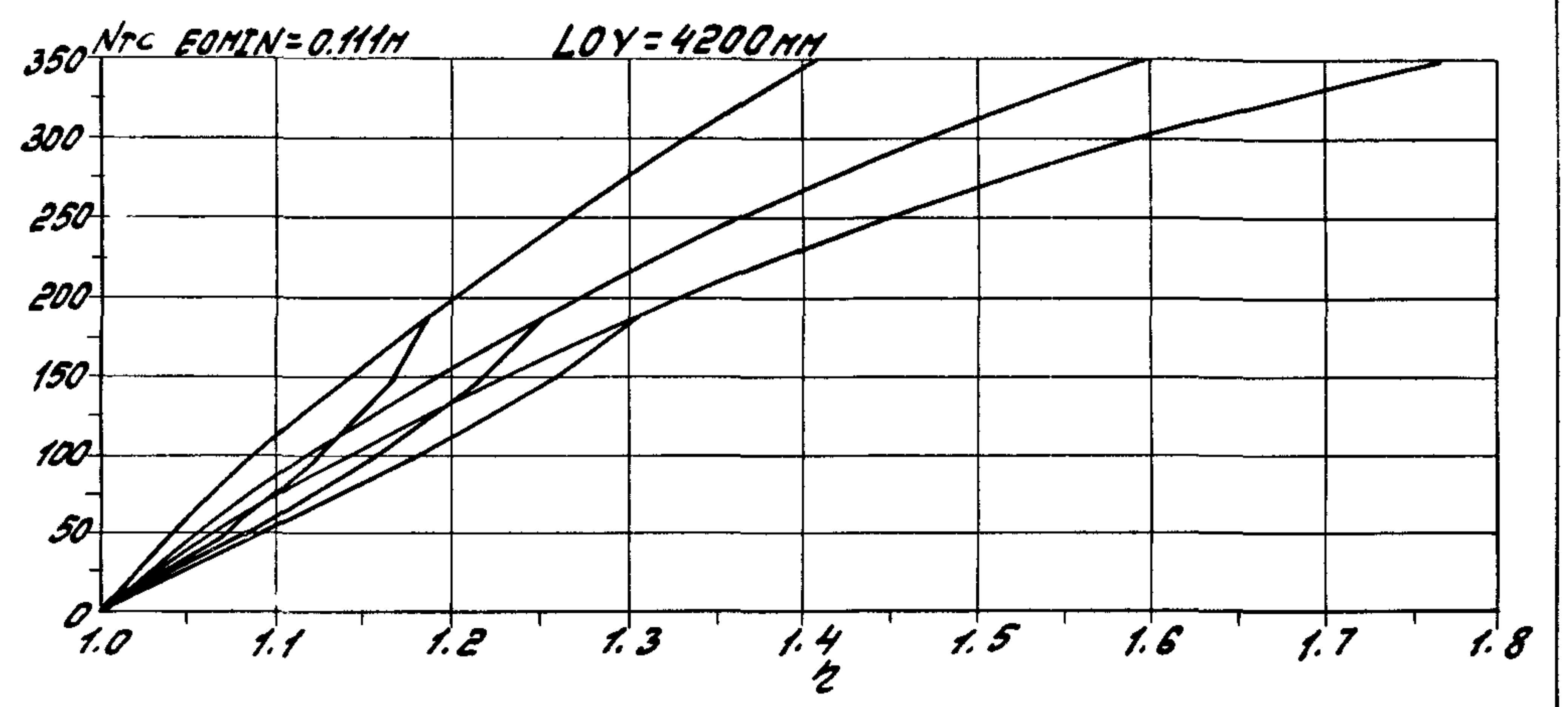
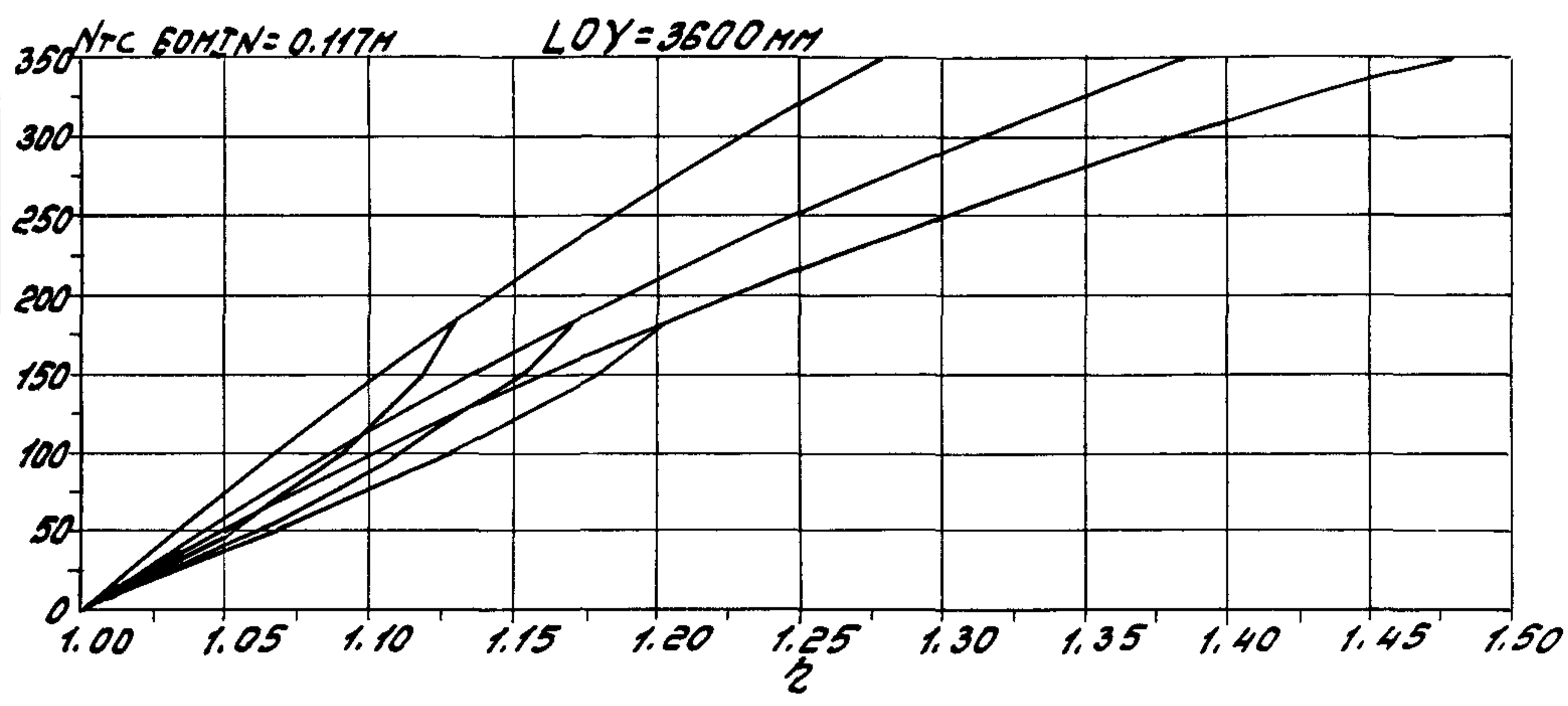
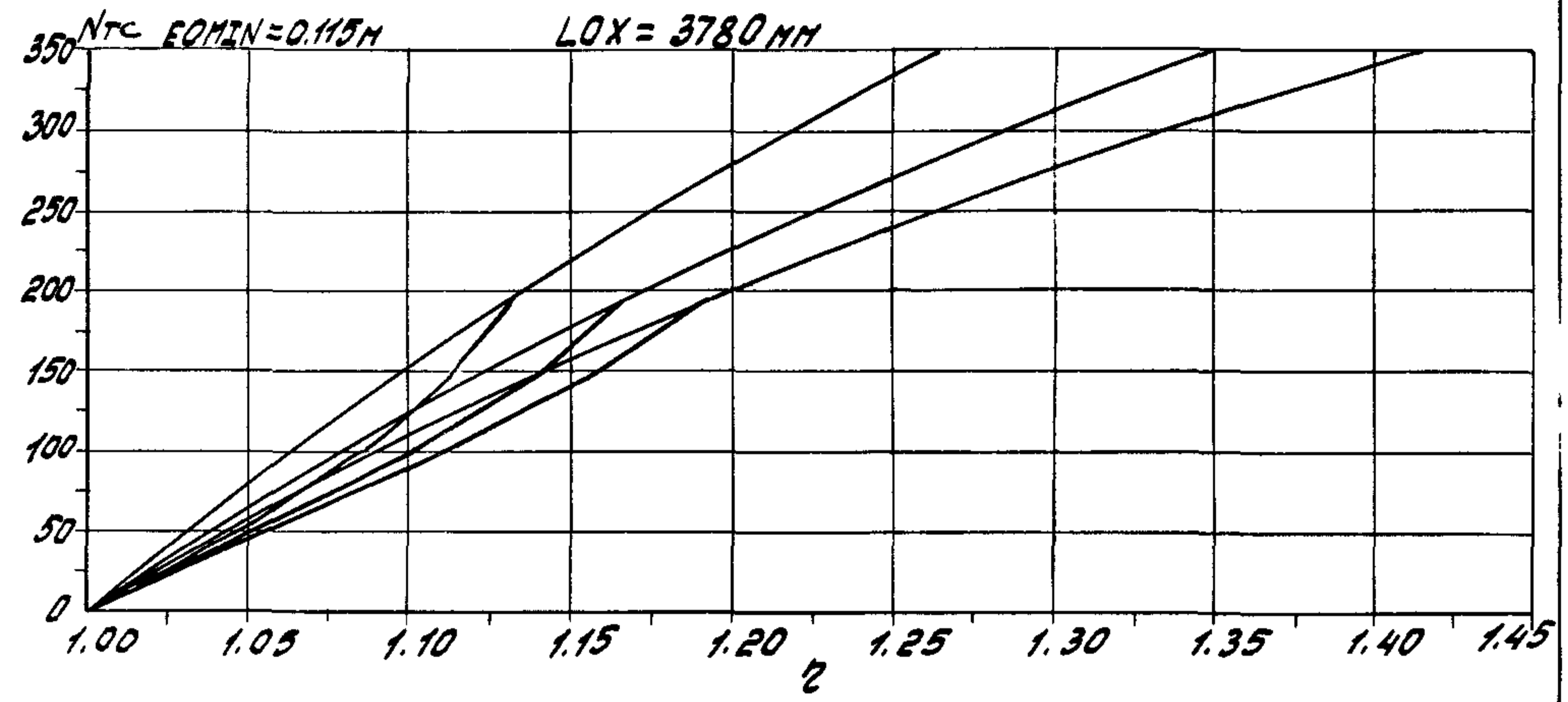
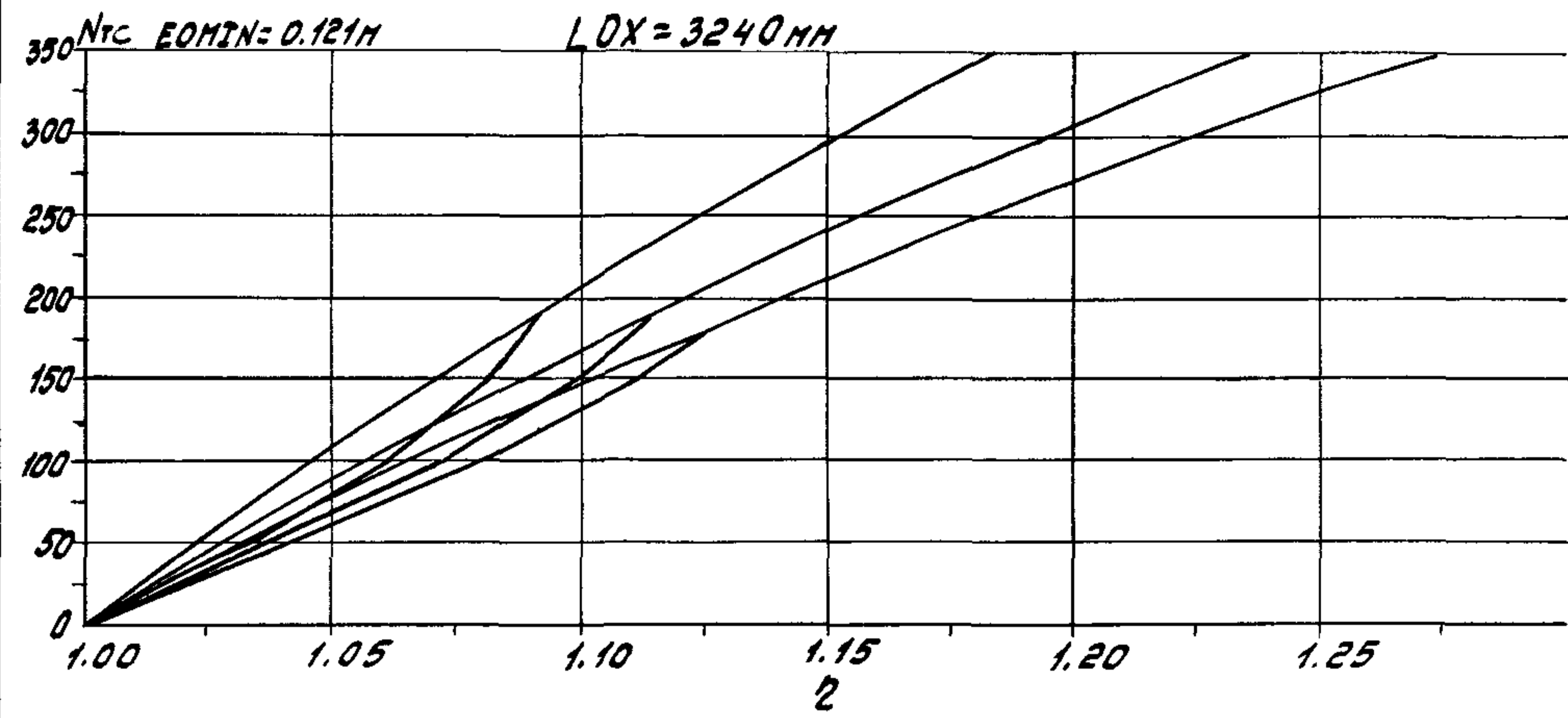

Шиб. N-1021. Подпись и дата взыск. инв.

1.020. 1-4 0-9 002 198

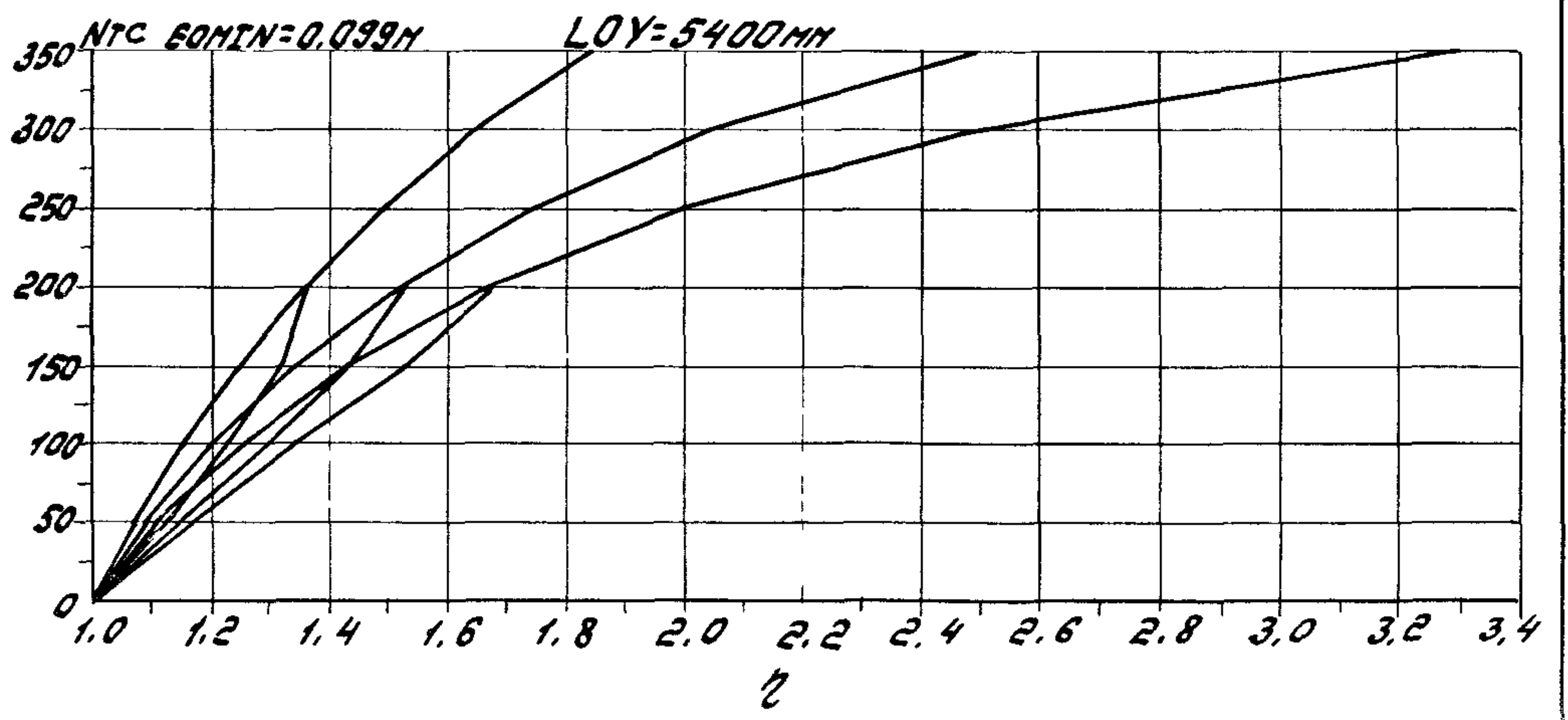
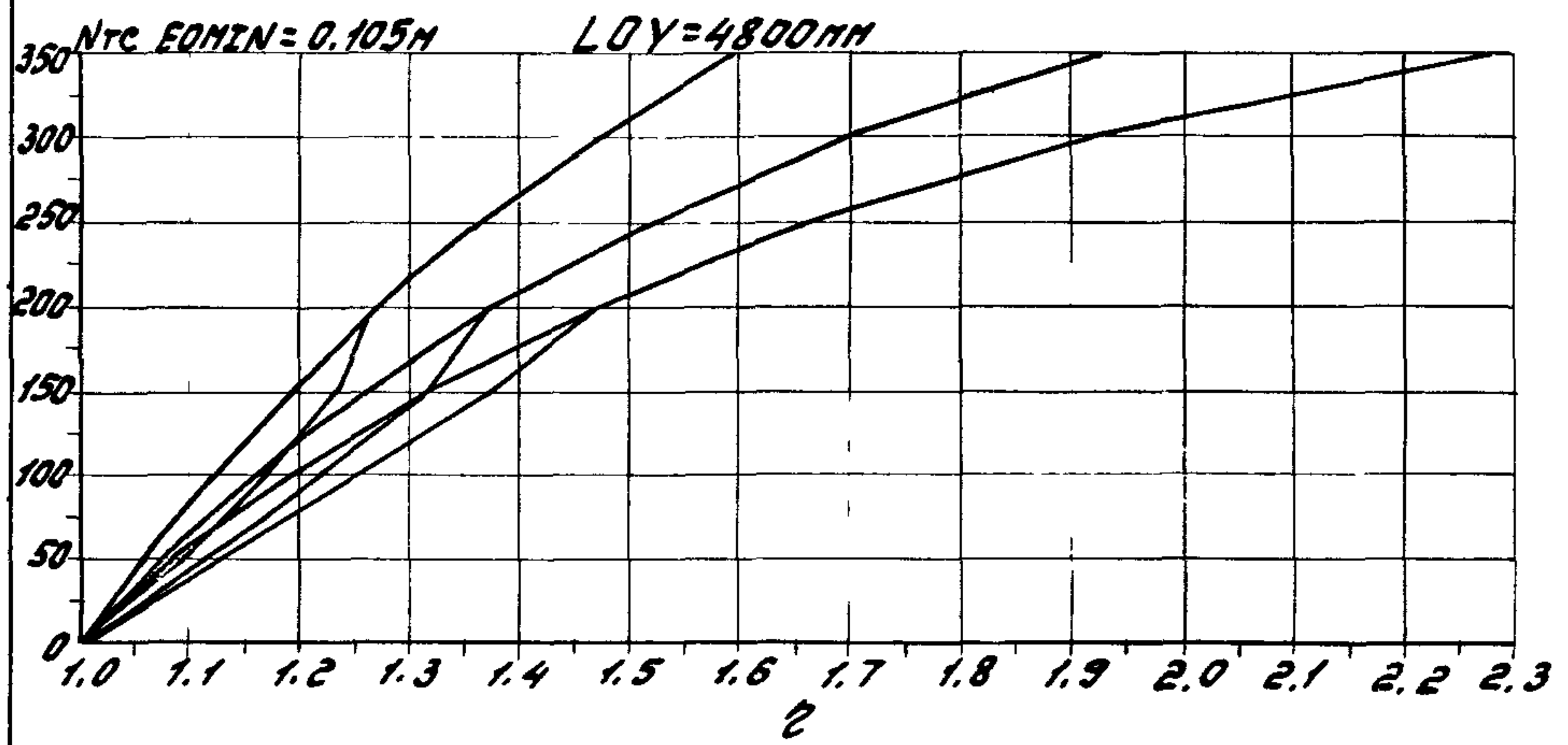
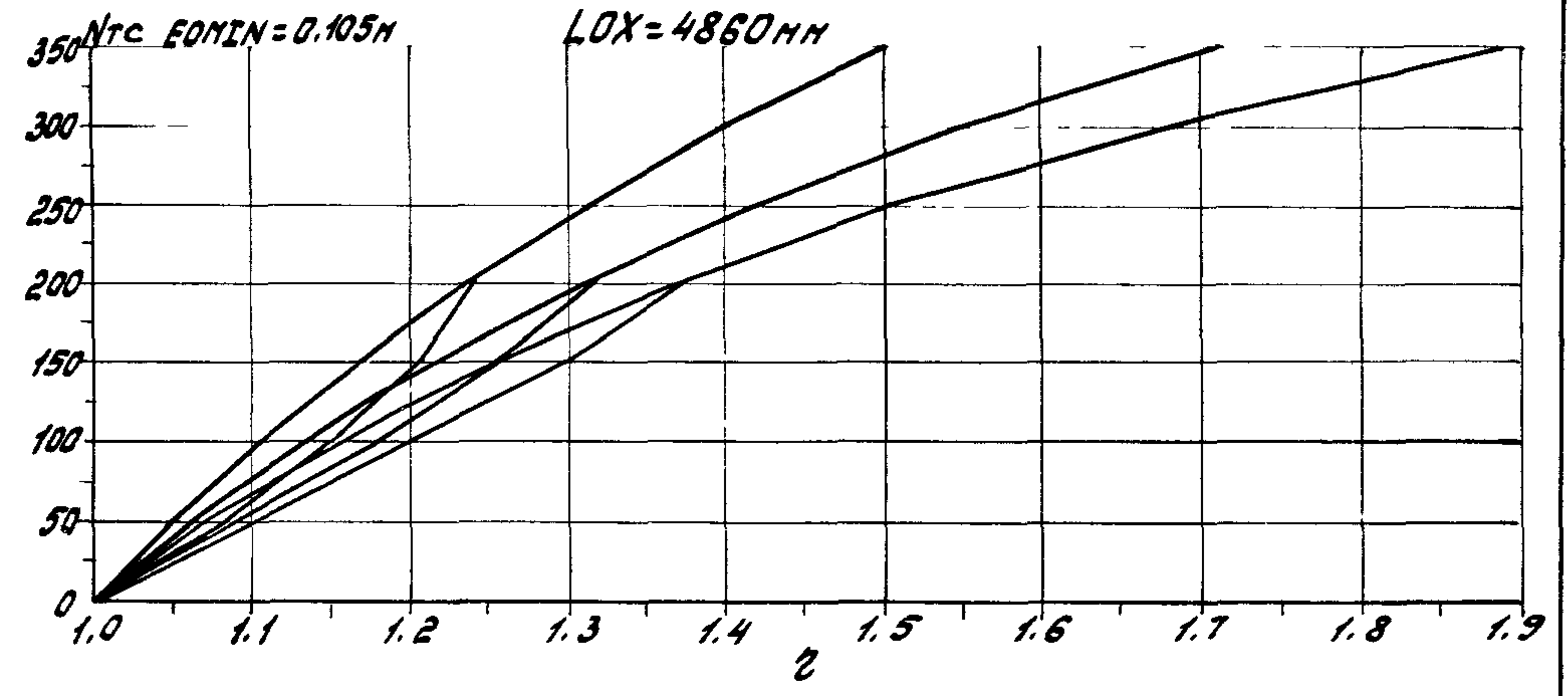
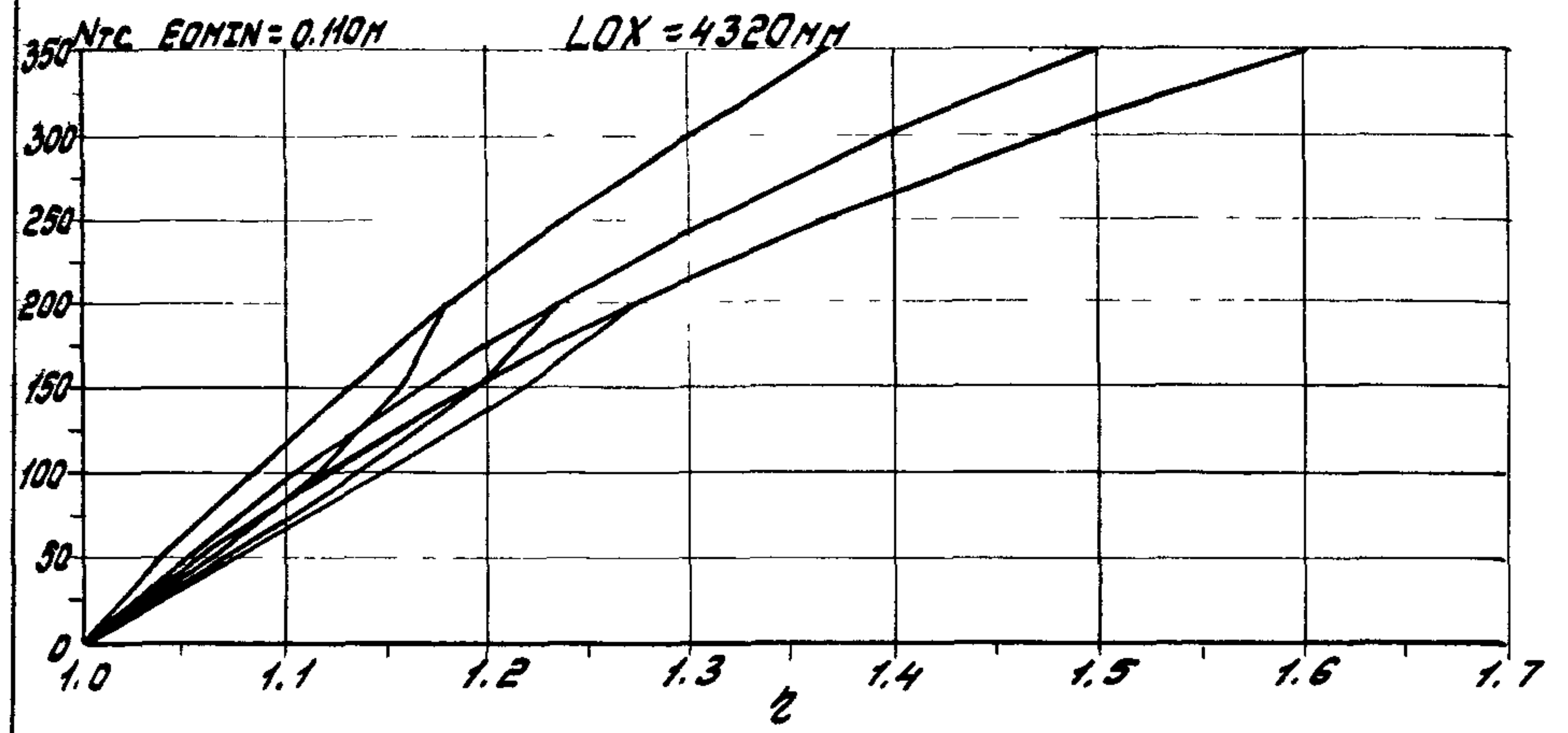

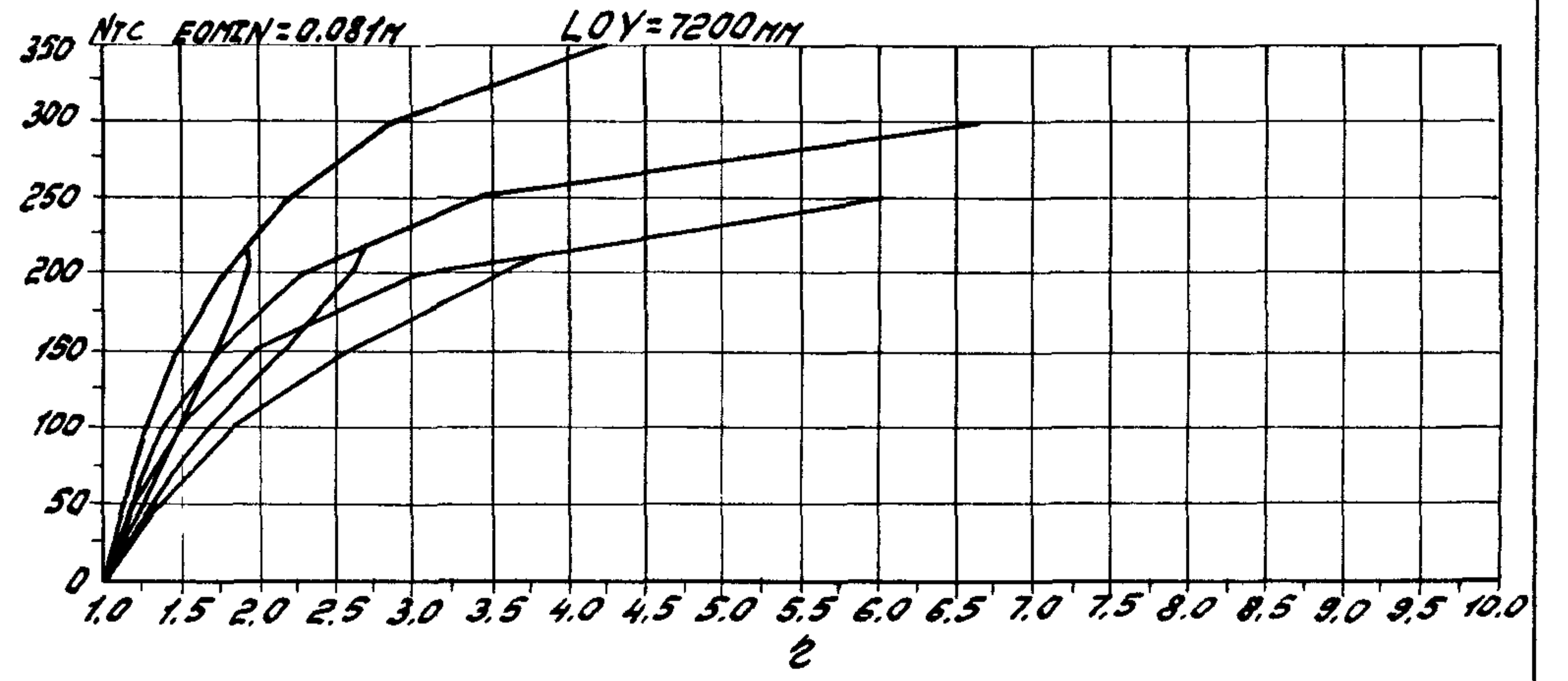
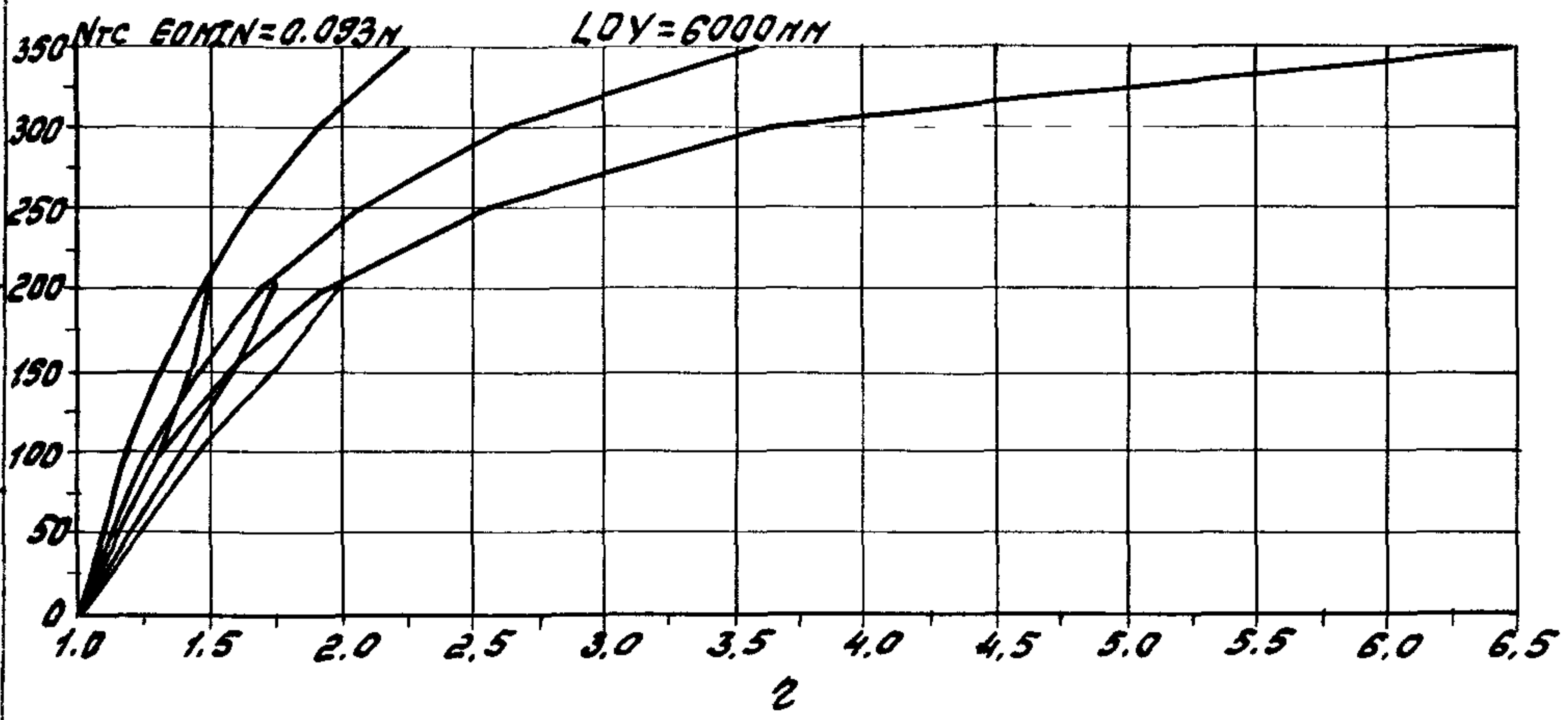
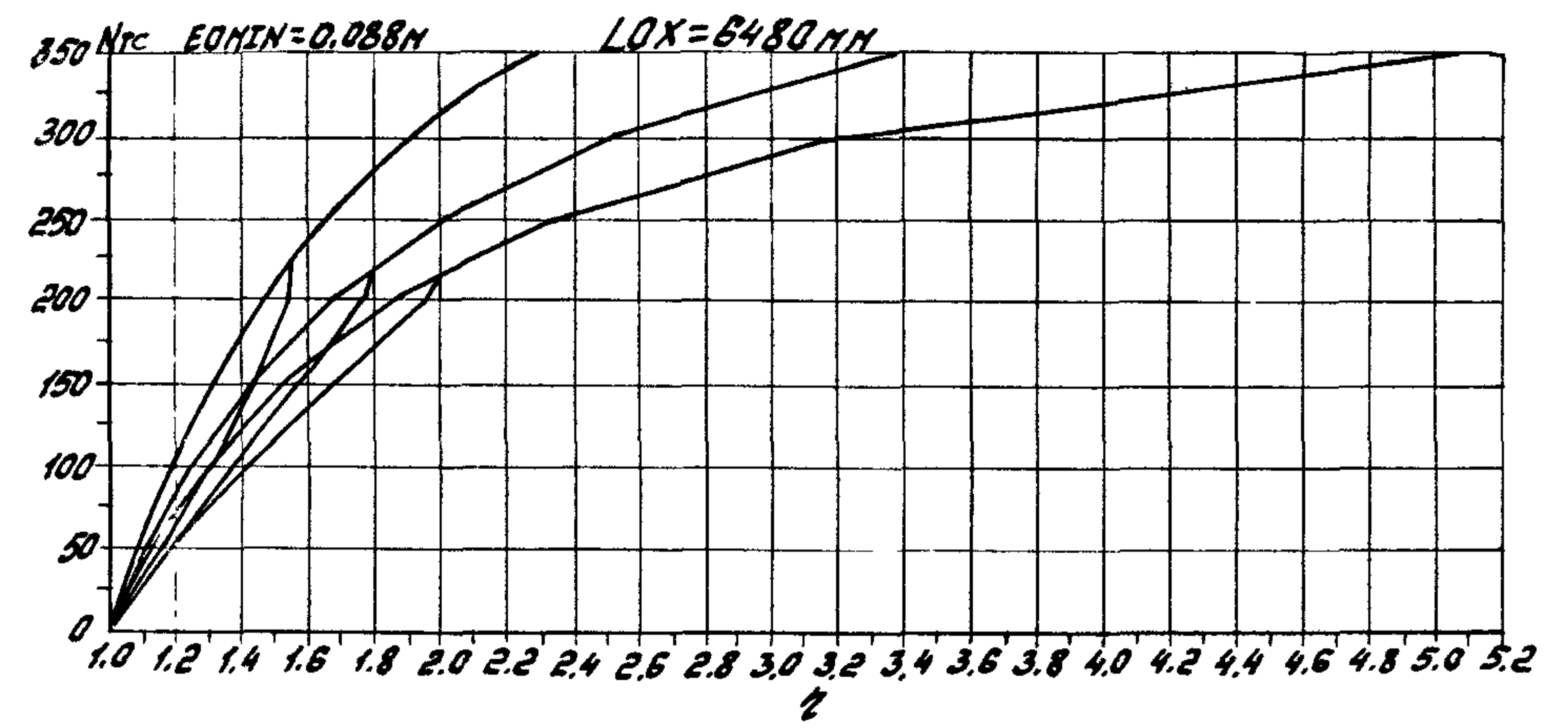
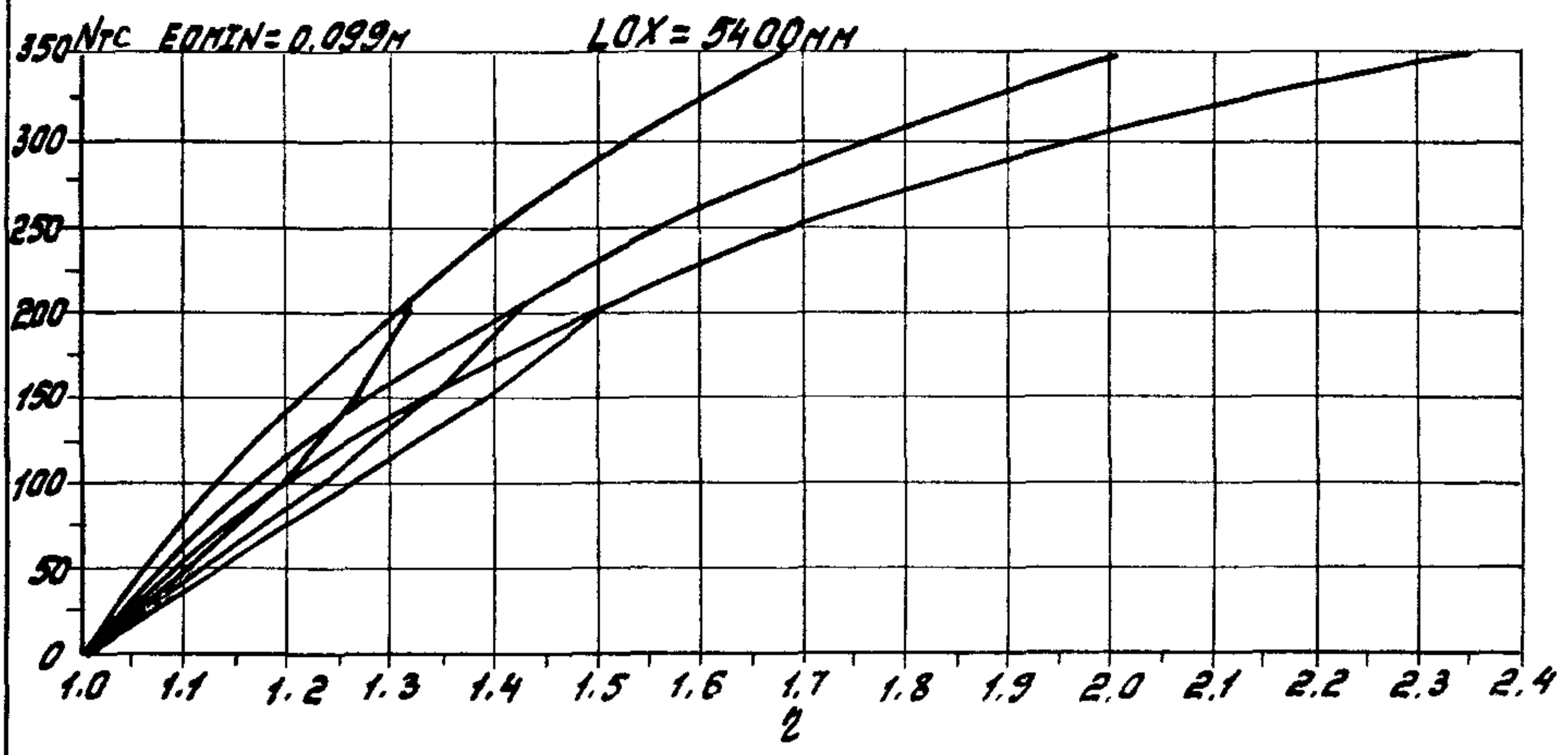

Укв. в. мода. / Страница в докум. / Страница в докум. / Страница в докум. / Страница в докум.

1.020.1-4 0-9 002 Лист 200

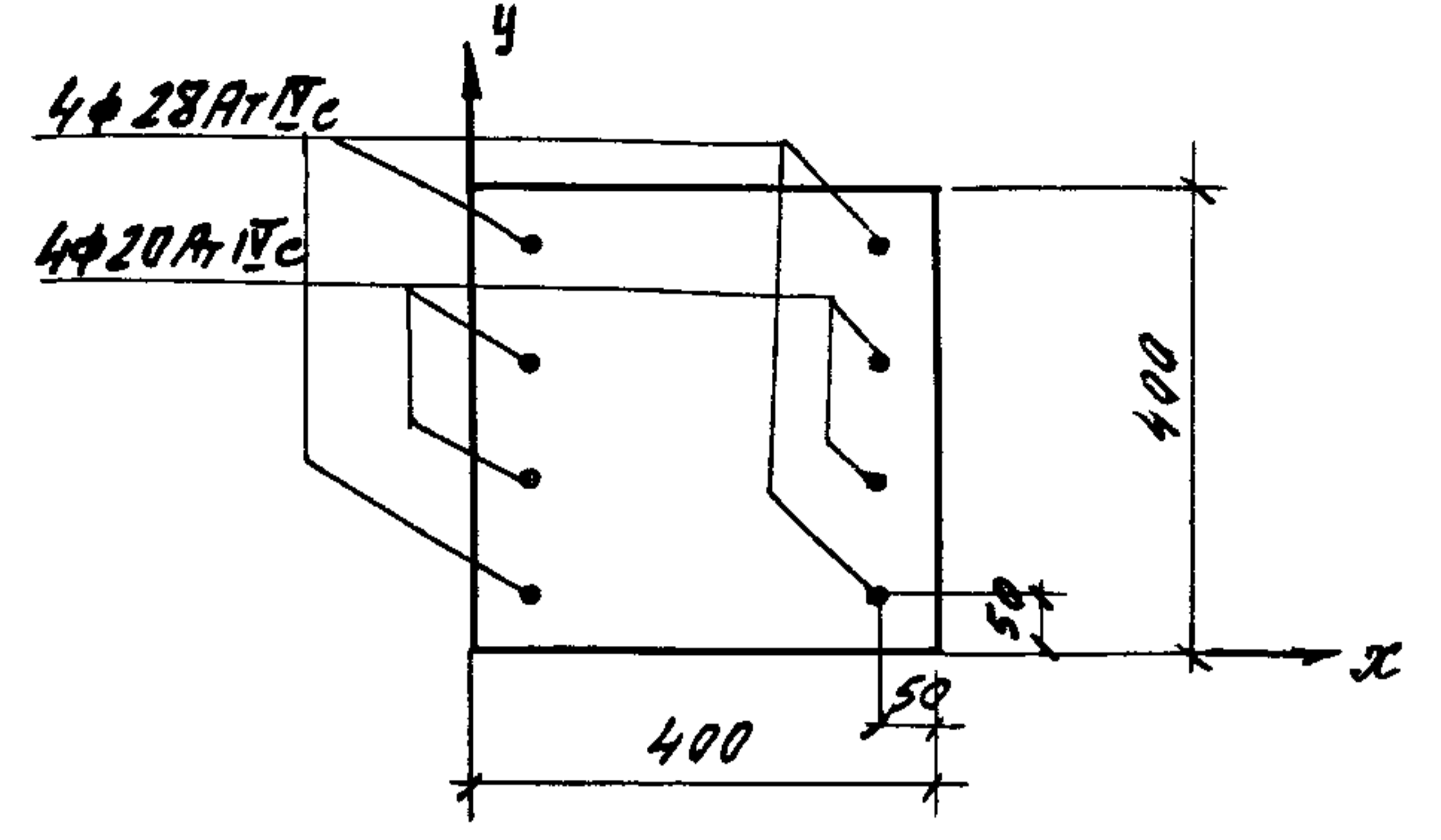
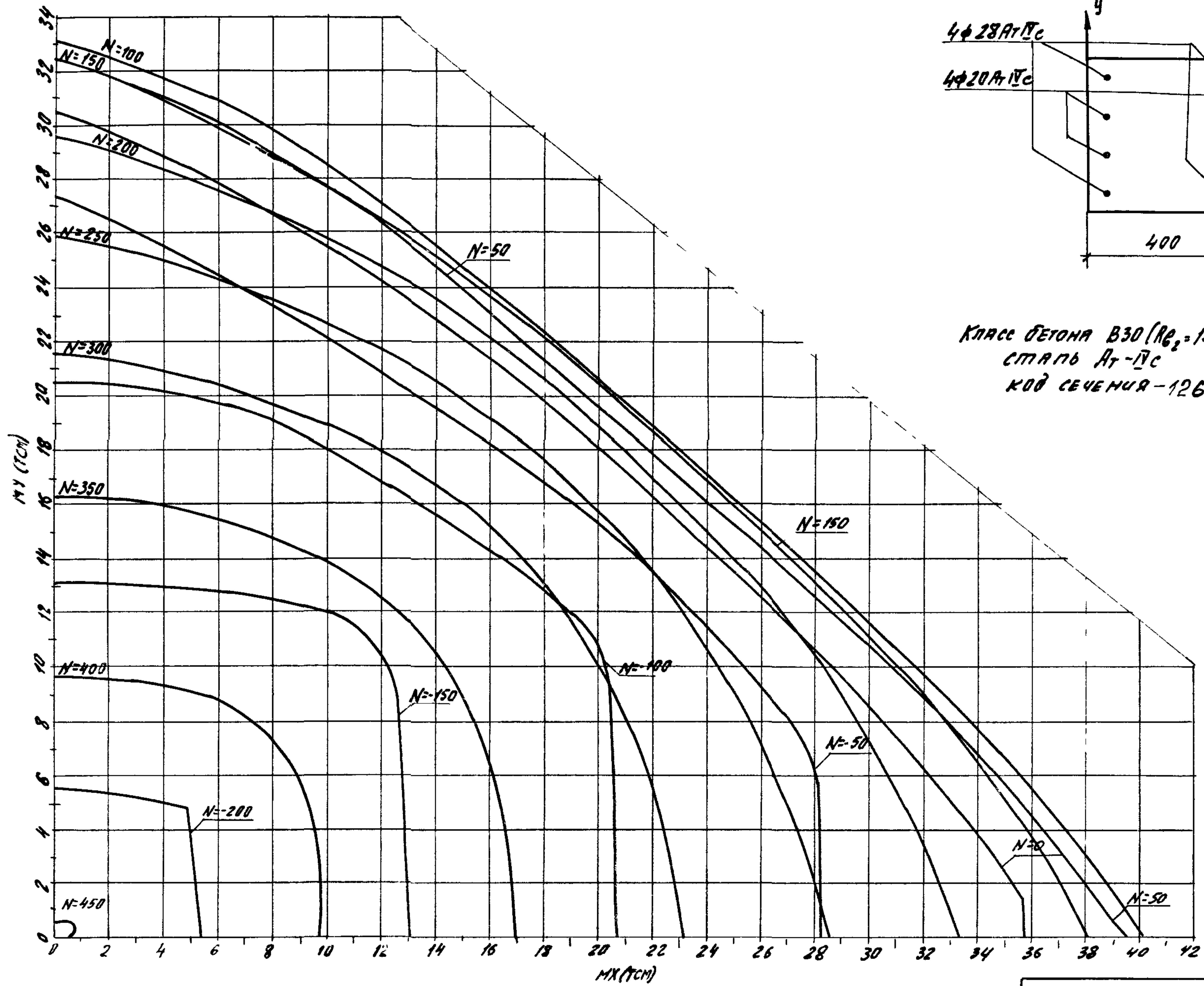

Класс бетона В30 ($R_{b2} = 15,3$ при учете $\gamma_{b2} = 1,1$)
 сталь Ат-III
 код сечения - 126a

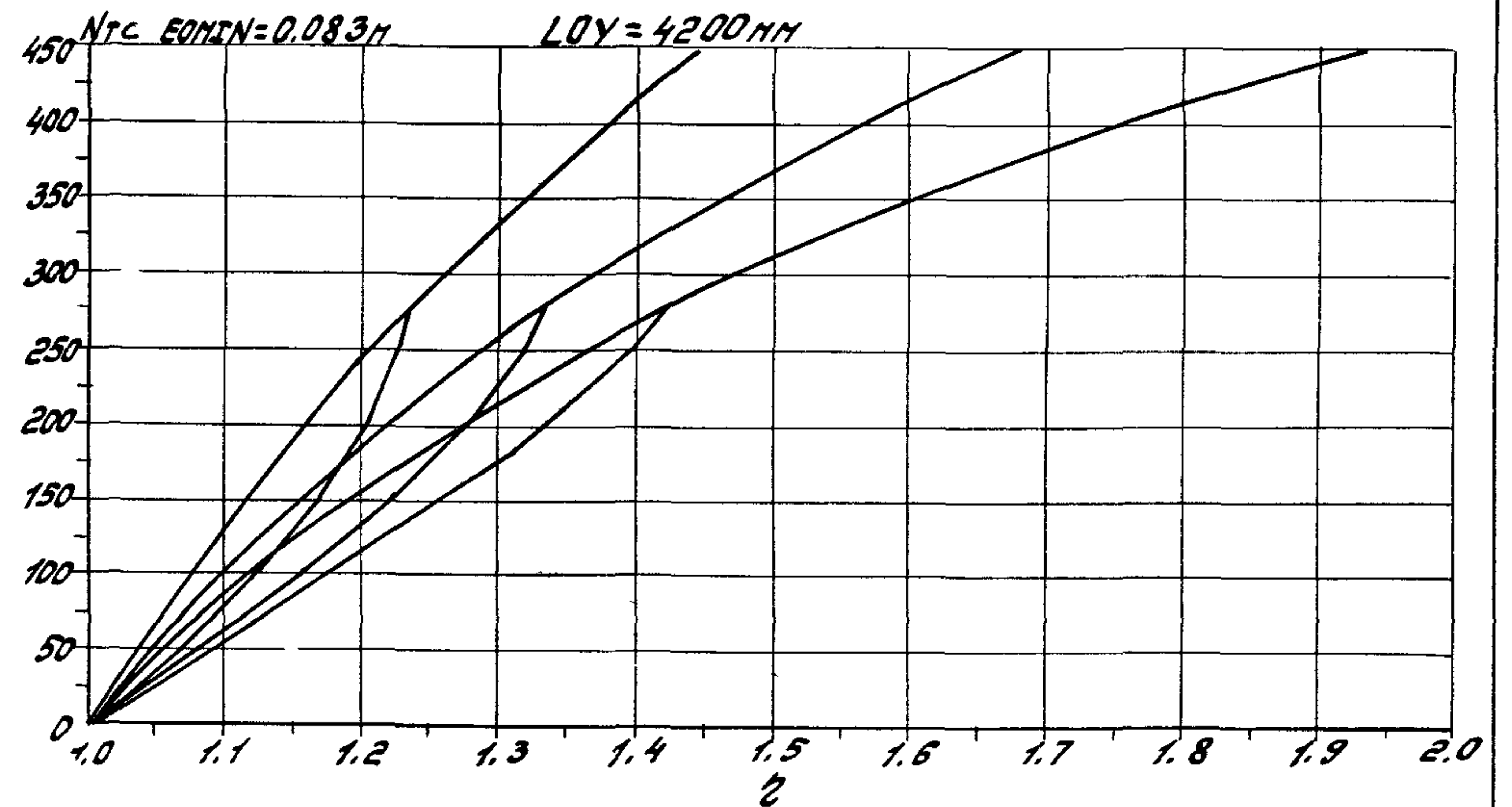
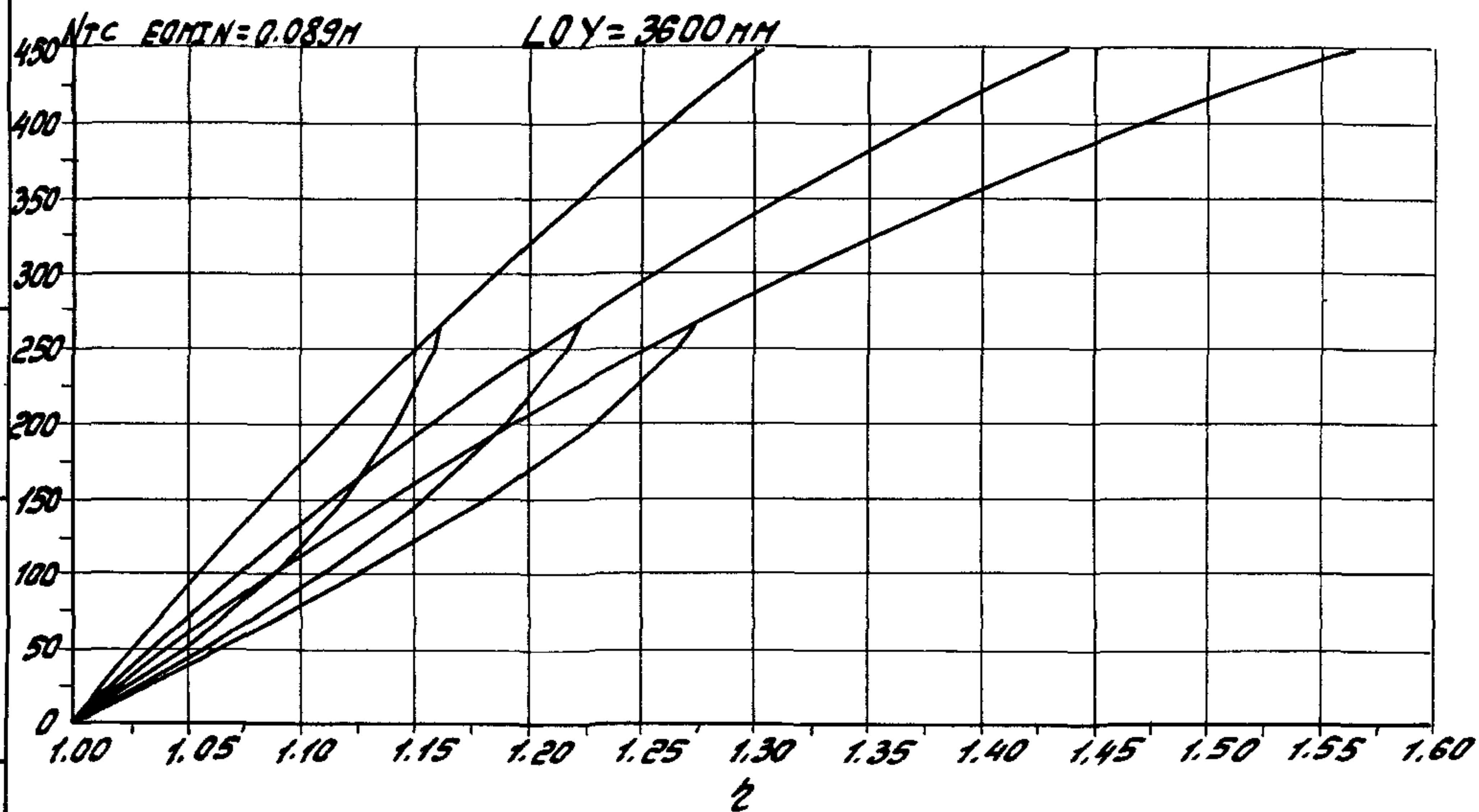
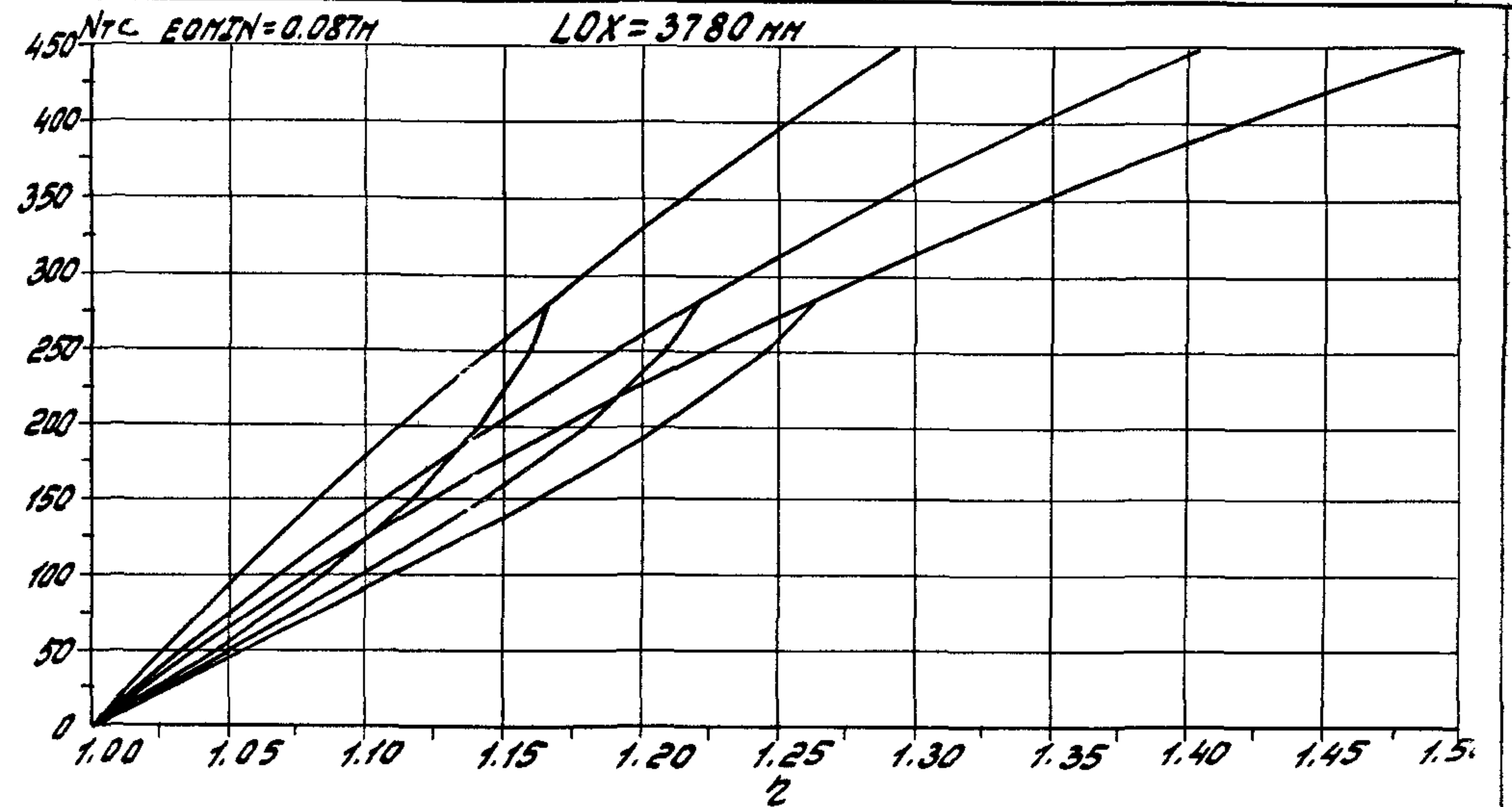
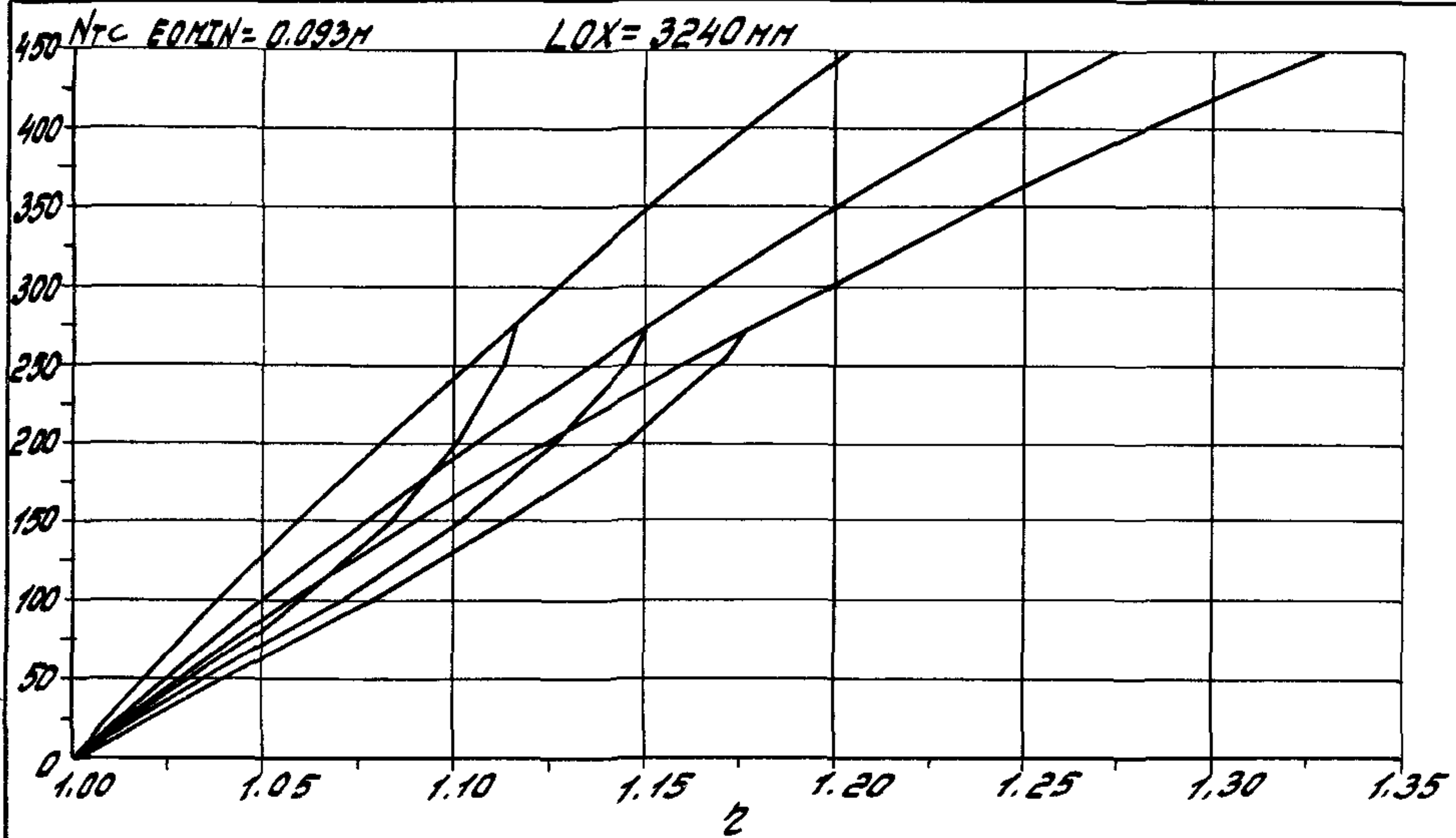

УГОДНИКОВЫЙ ВИД ИСПОЛ. В ДЕТ. В 30 М. УИБ. N

1.020.1-4 0-9 002

Лист
202

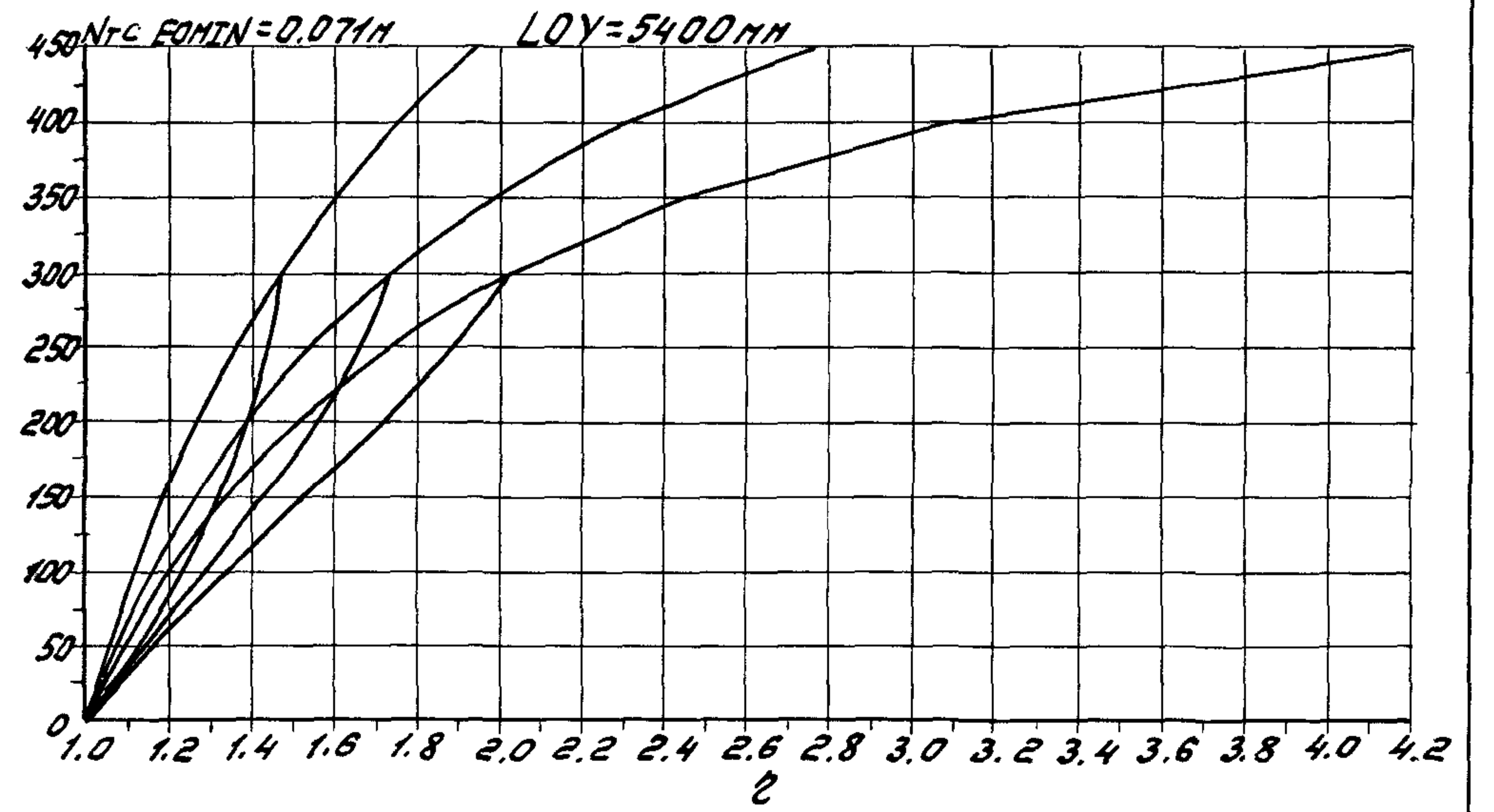
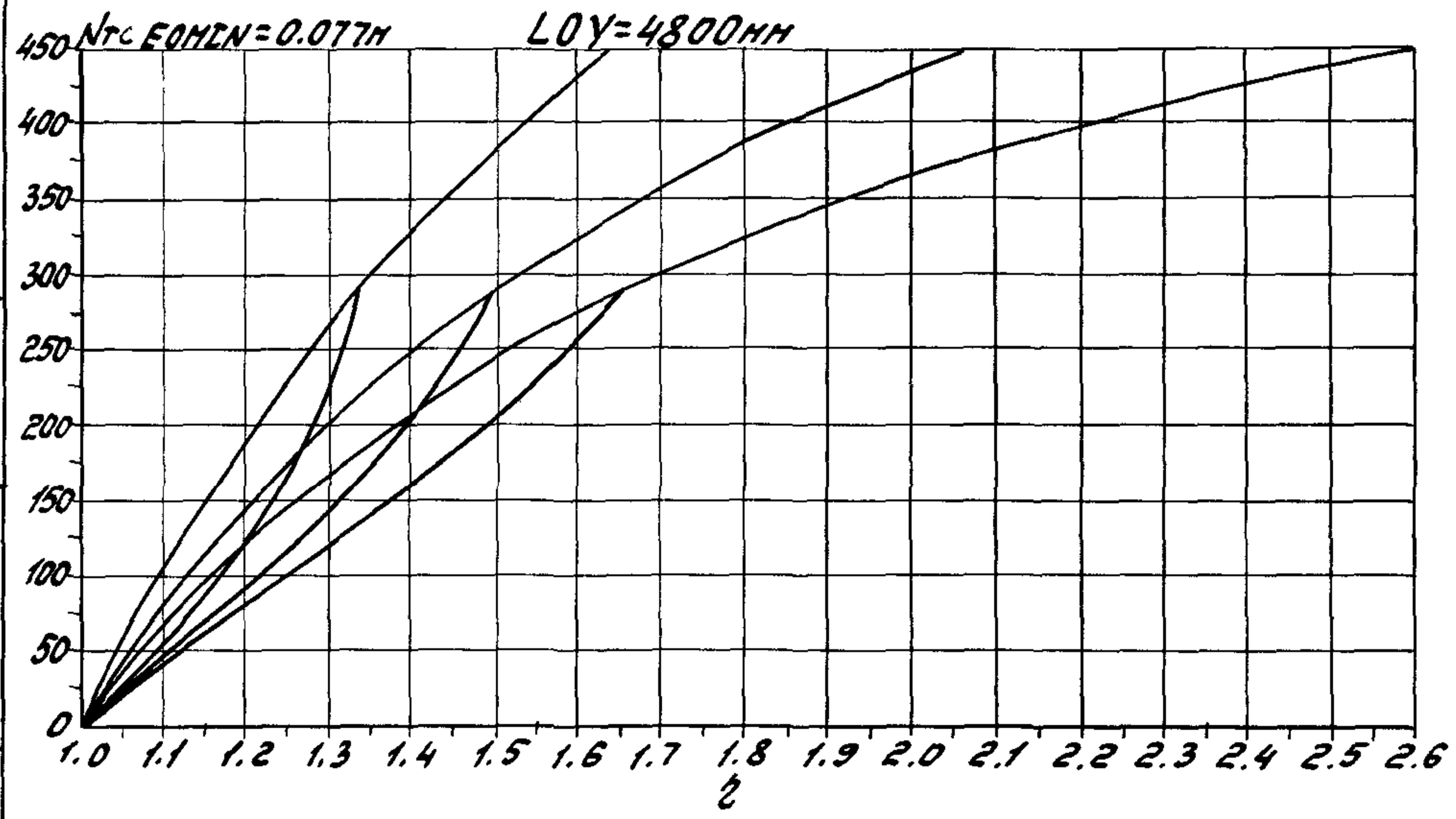
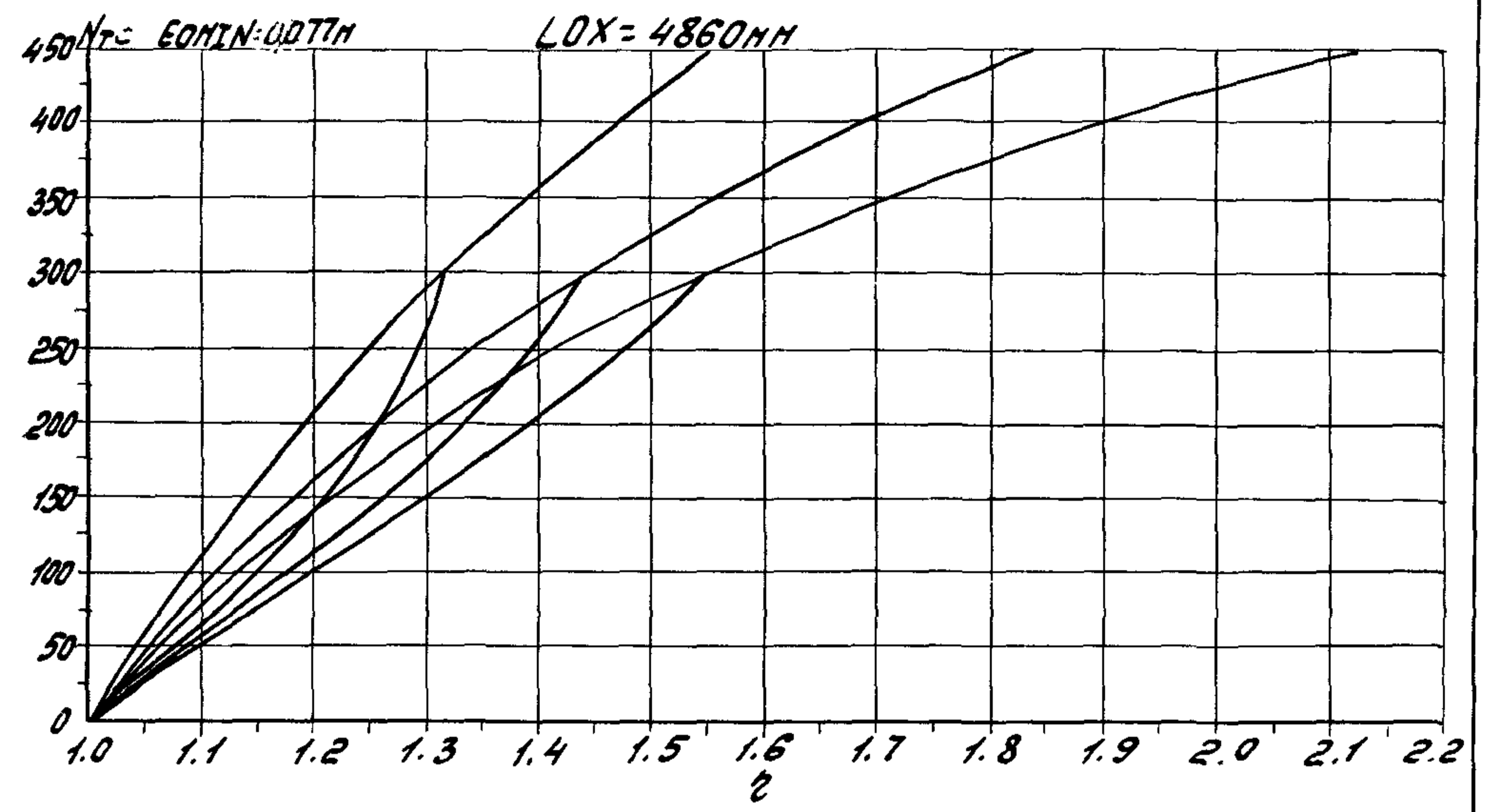
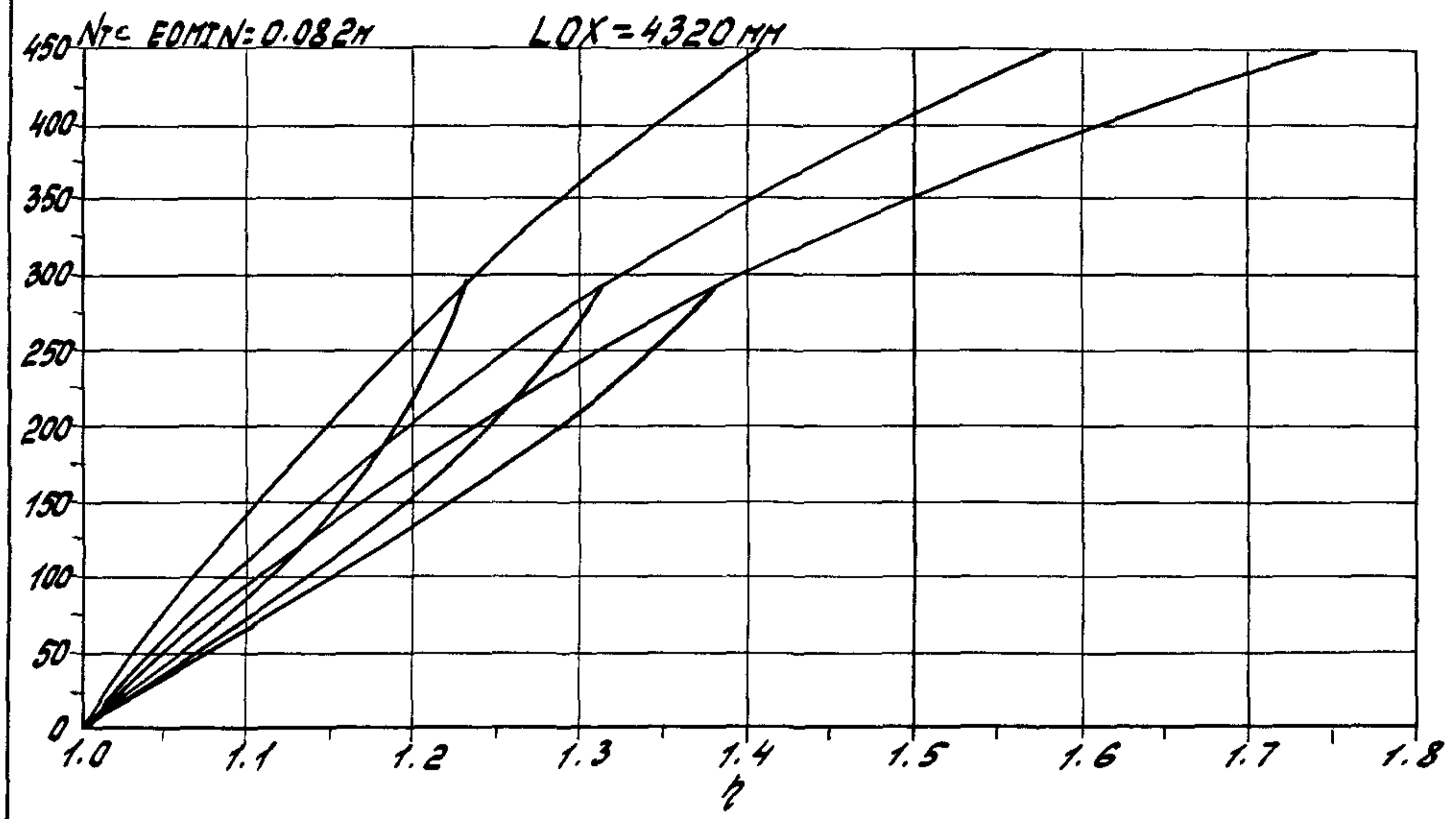

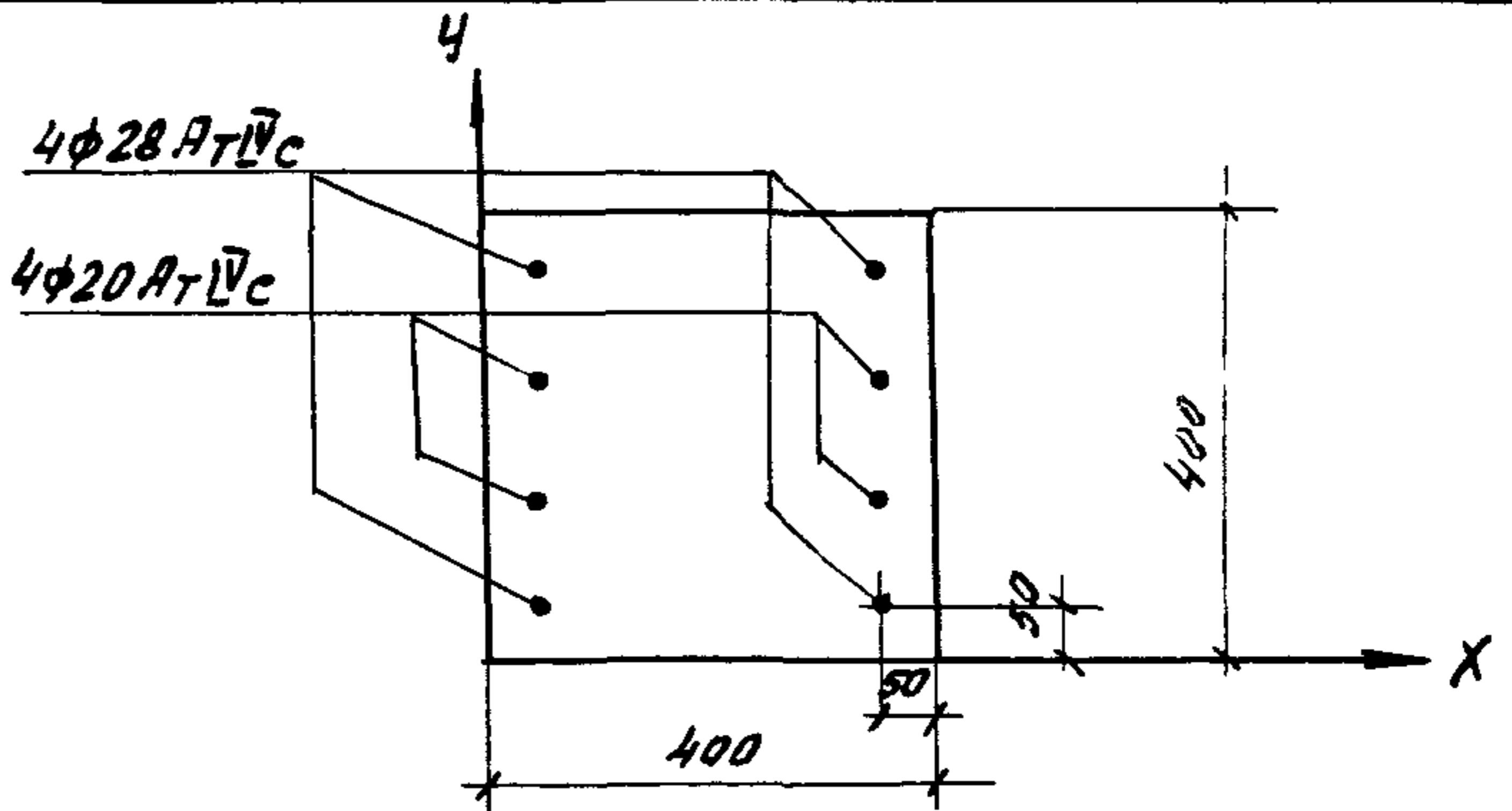
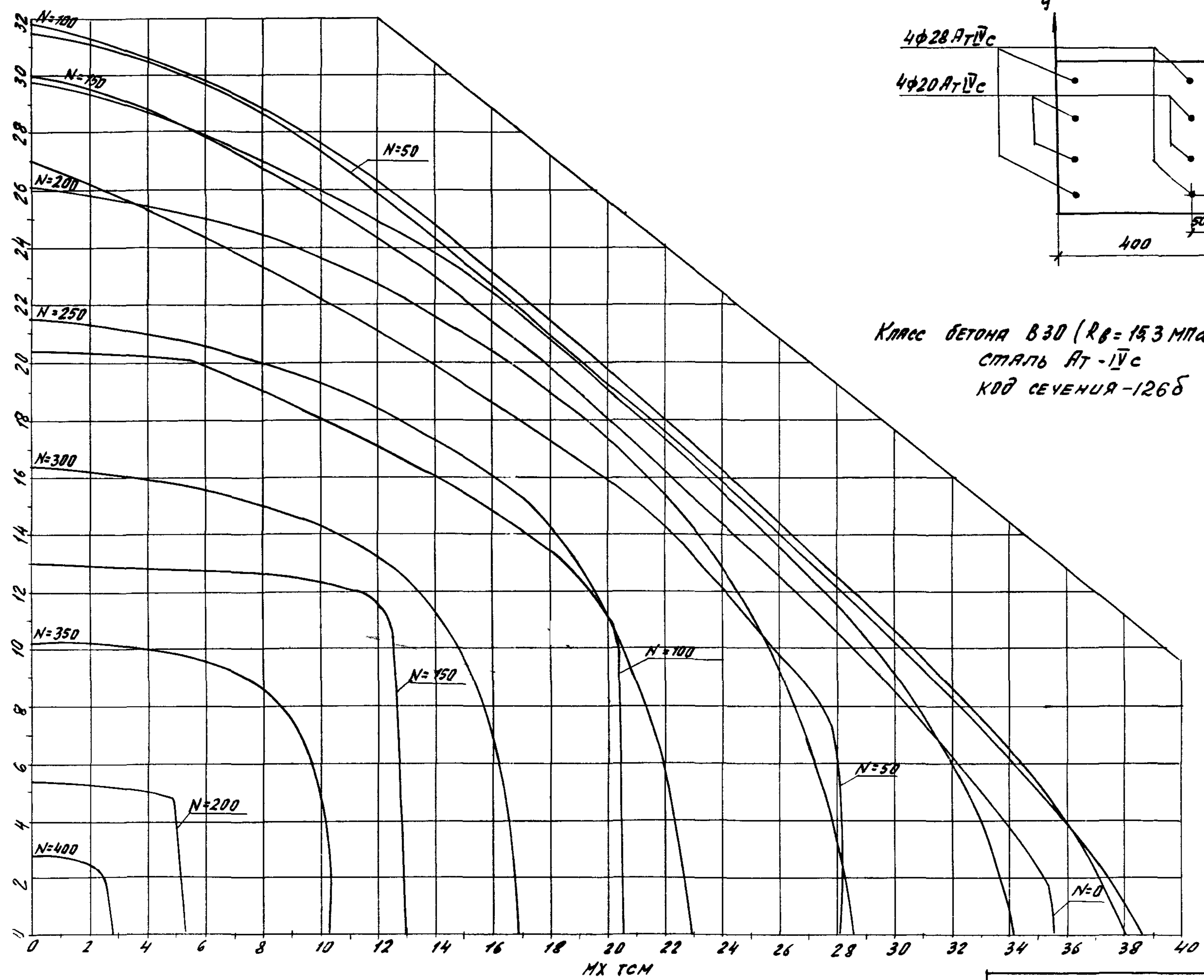

Класс бетона В30 ($R_b = 15.3 \text{ МПа}$ при $\gamma_{c2} = 0.90$)
 сталь АТ-IVс
 код сечения -1268

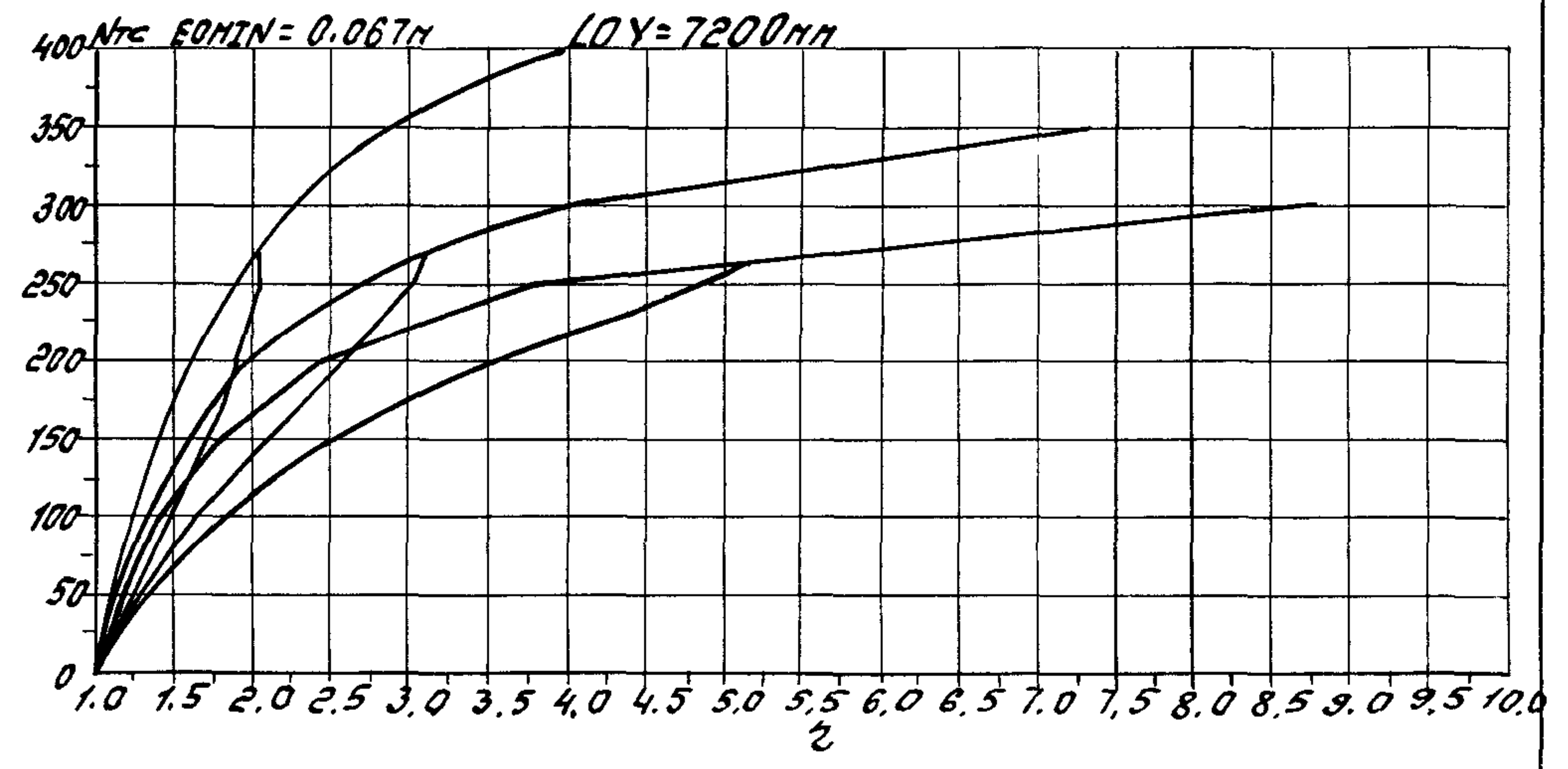
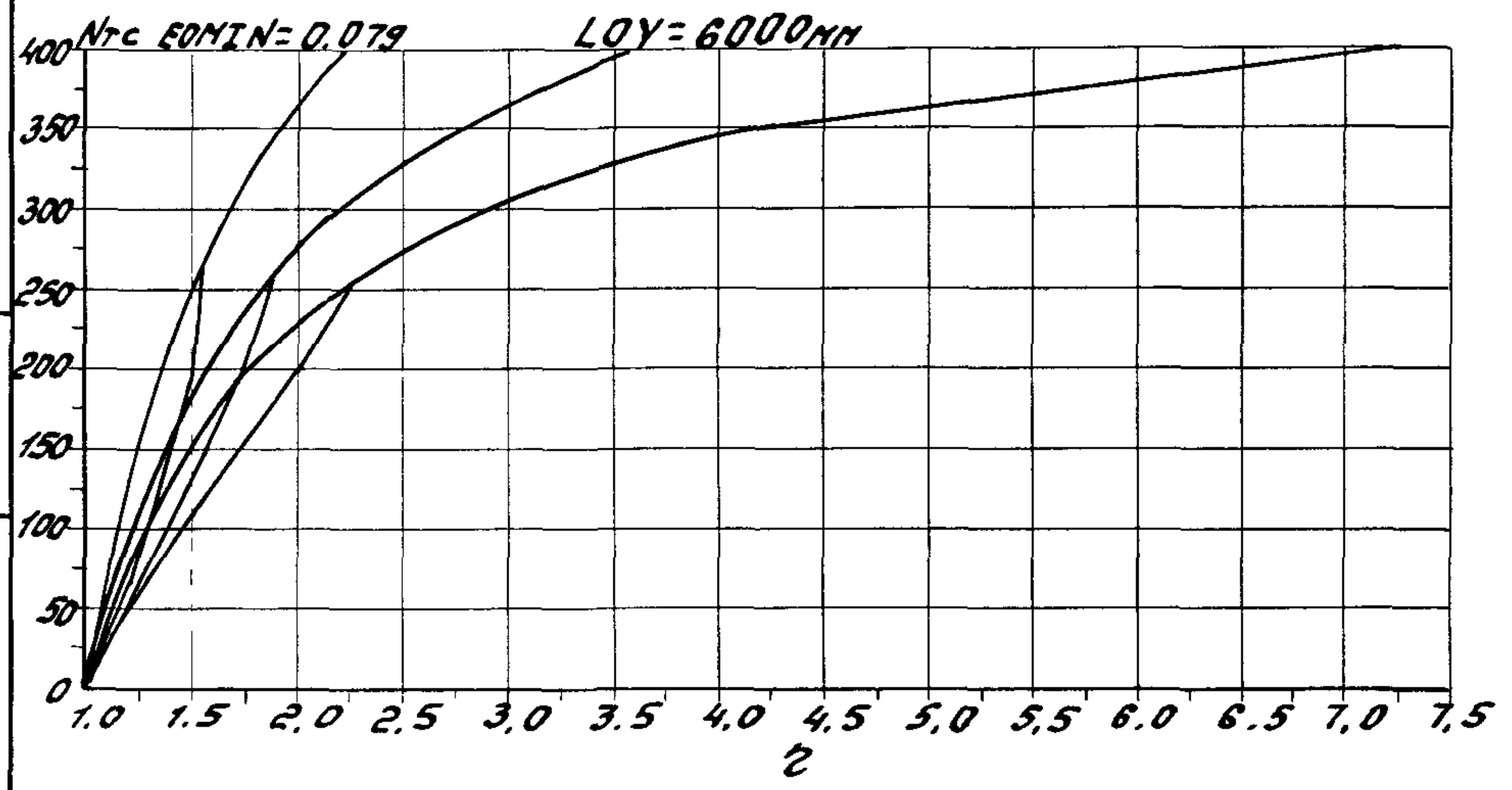
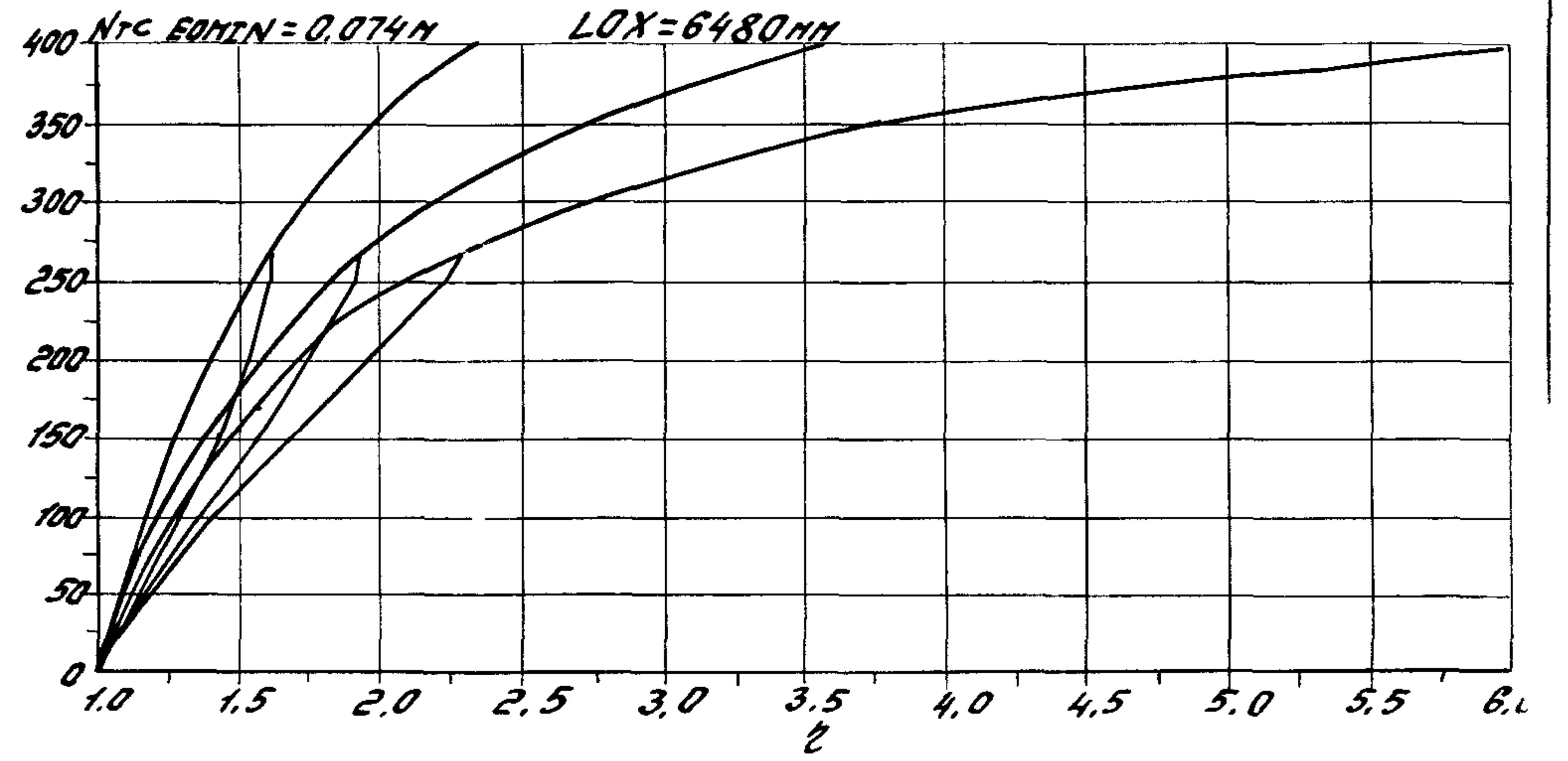
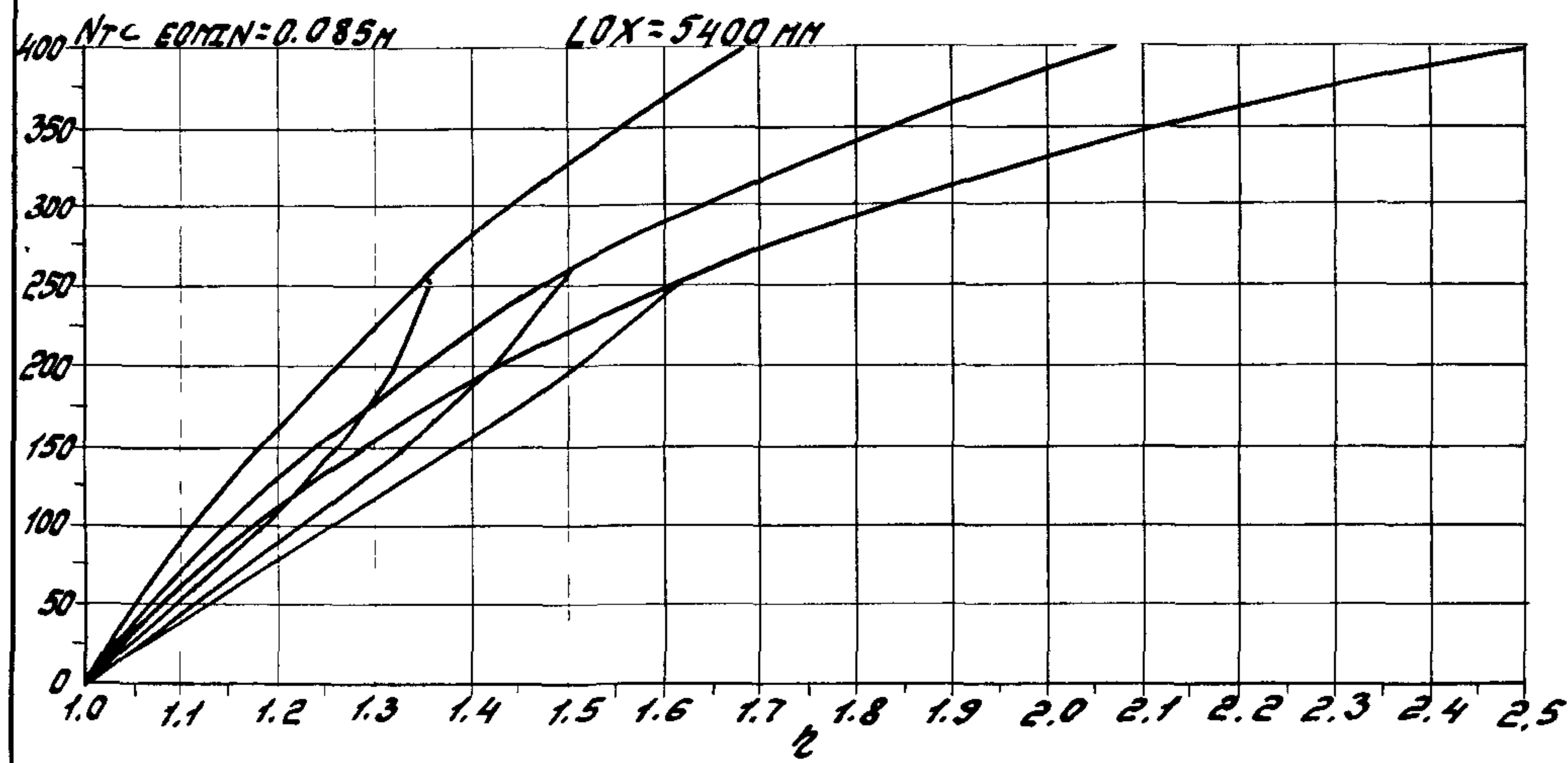

УЧБ. N 10002.1/000156 У ДОТО ВЗРОМ УНБН

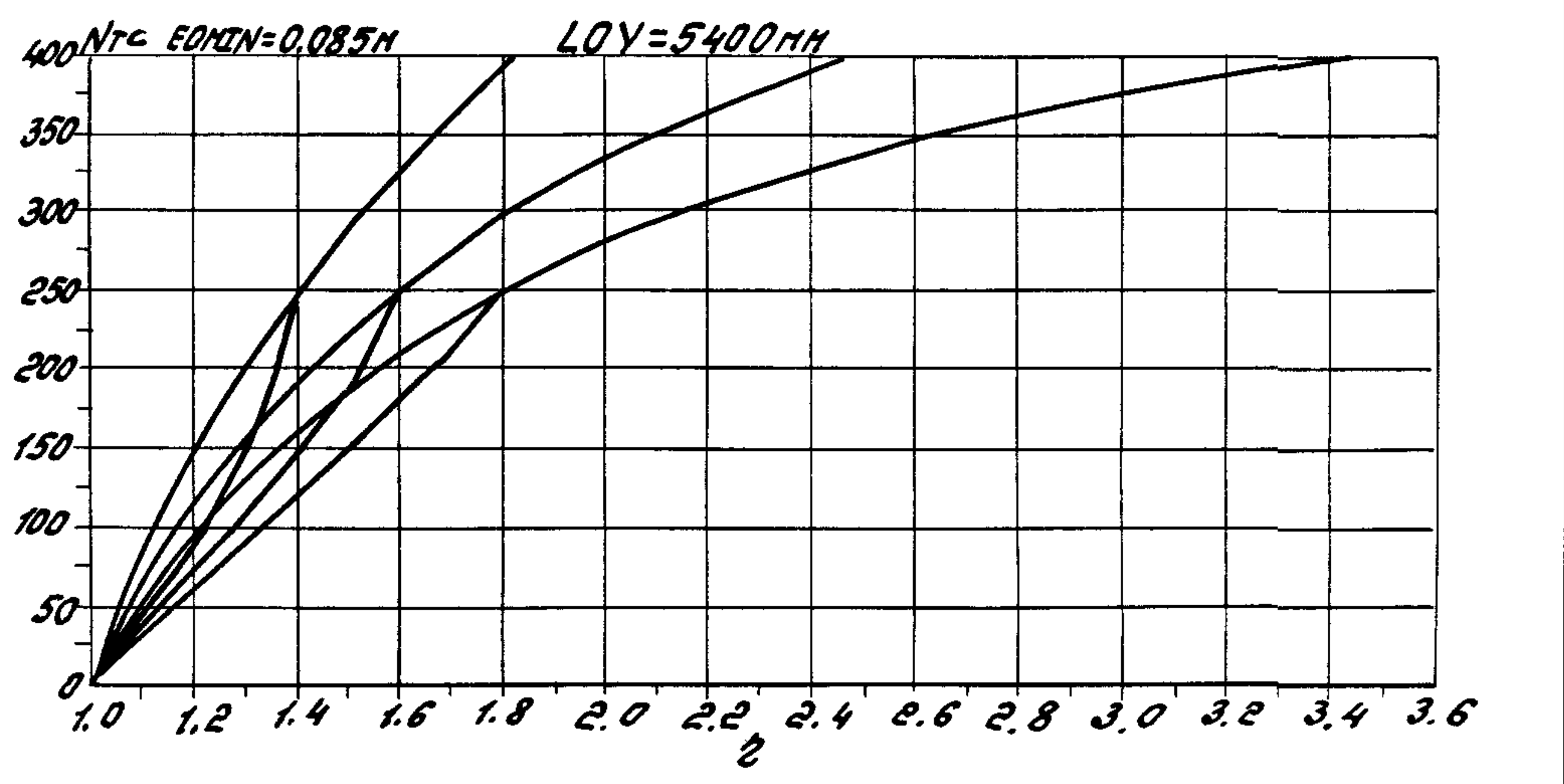
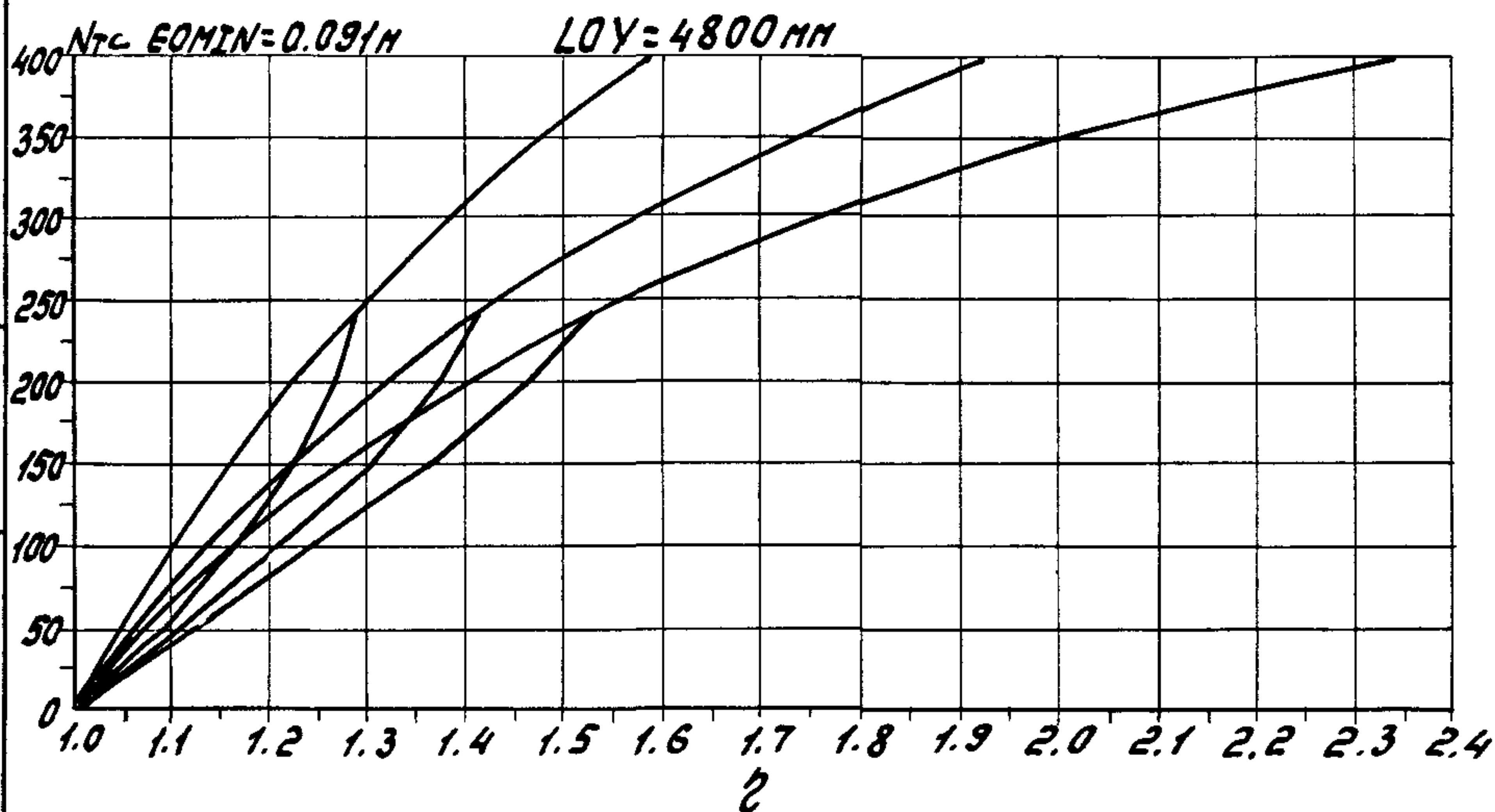
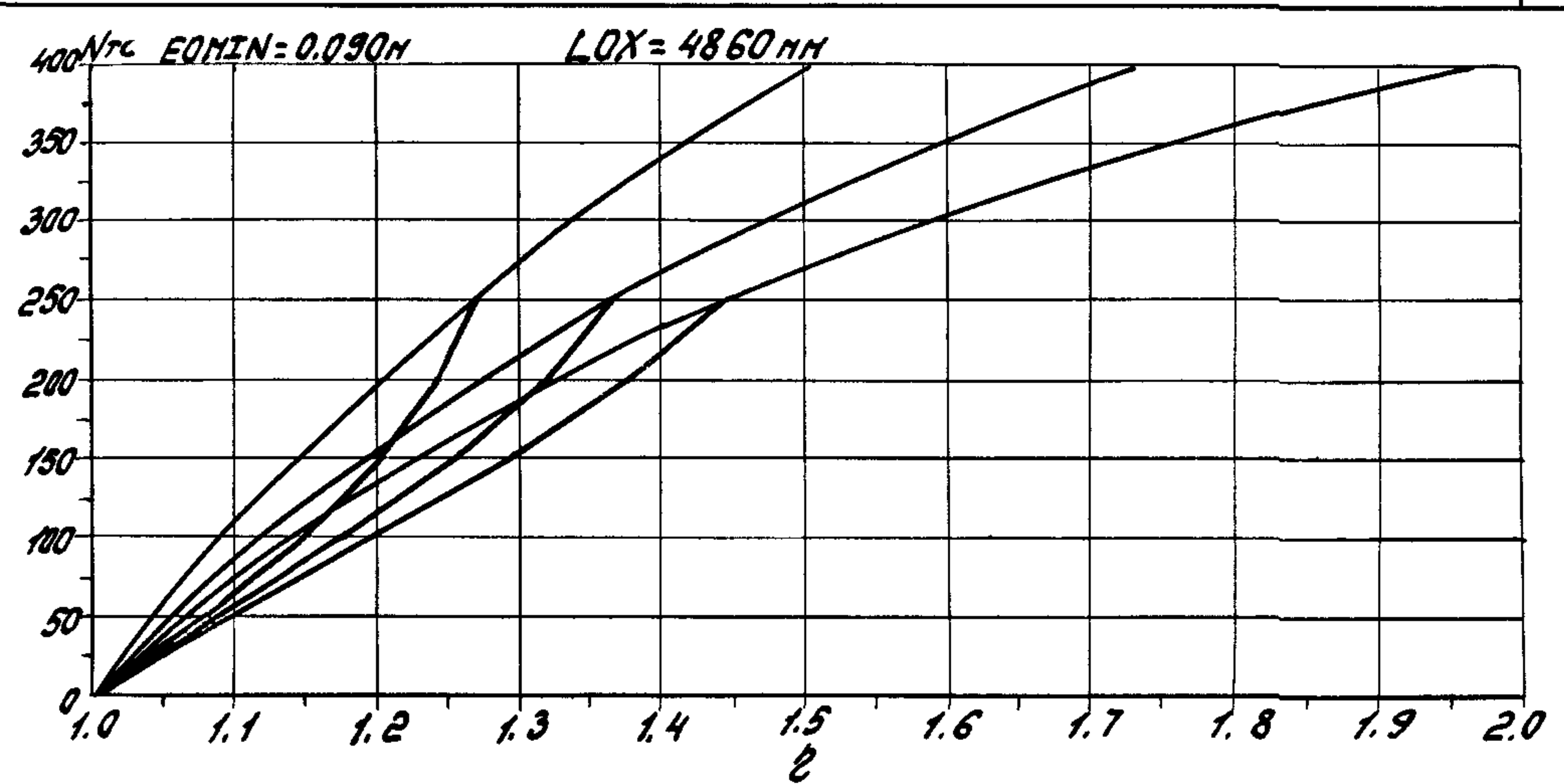
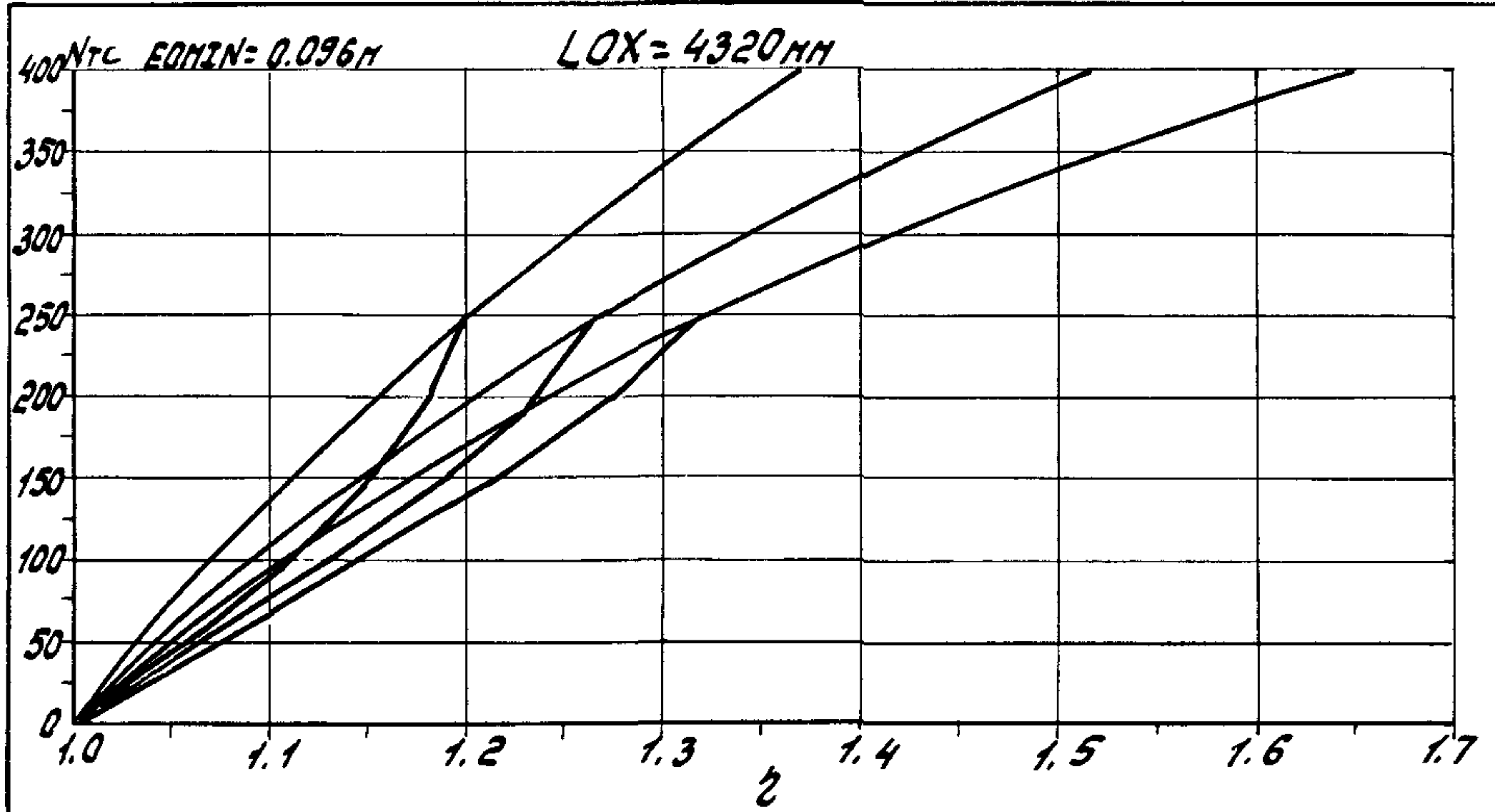

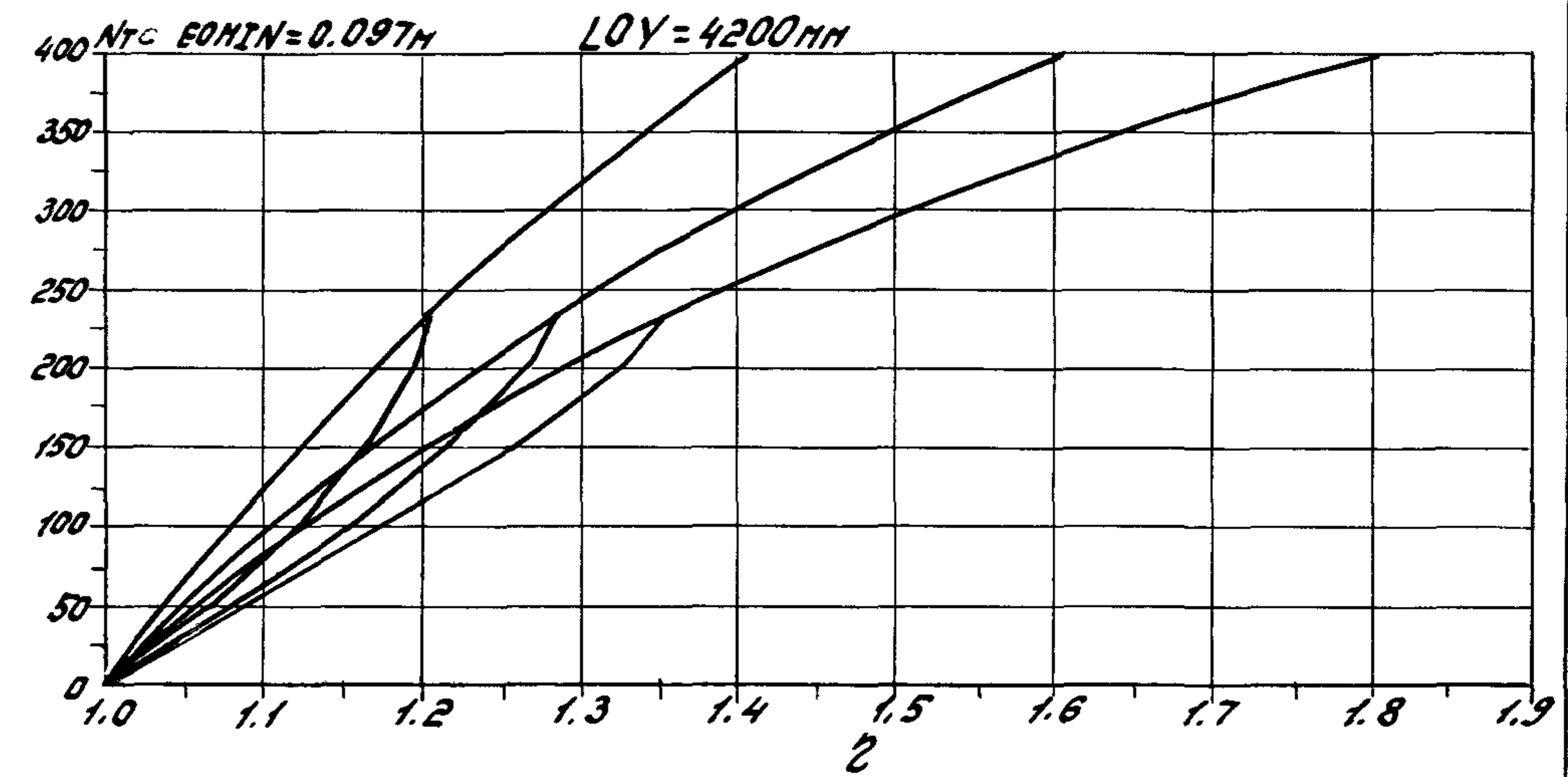
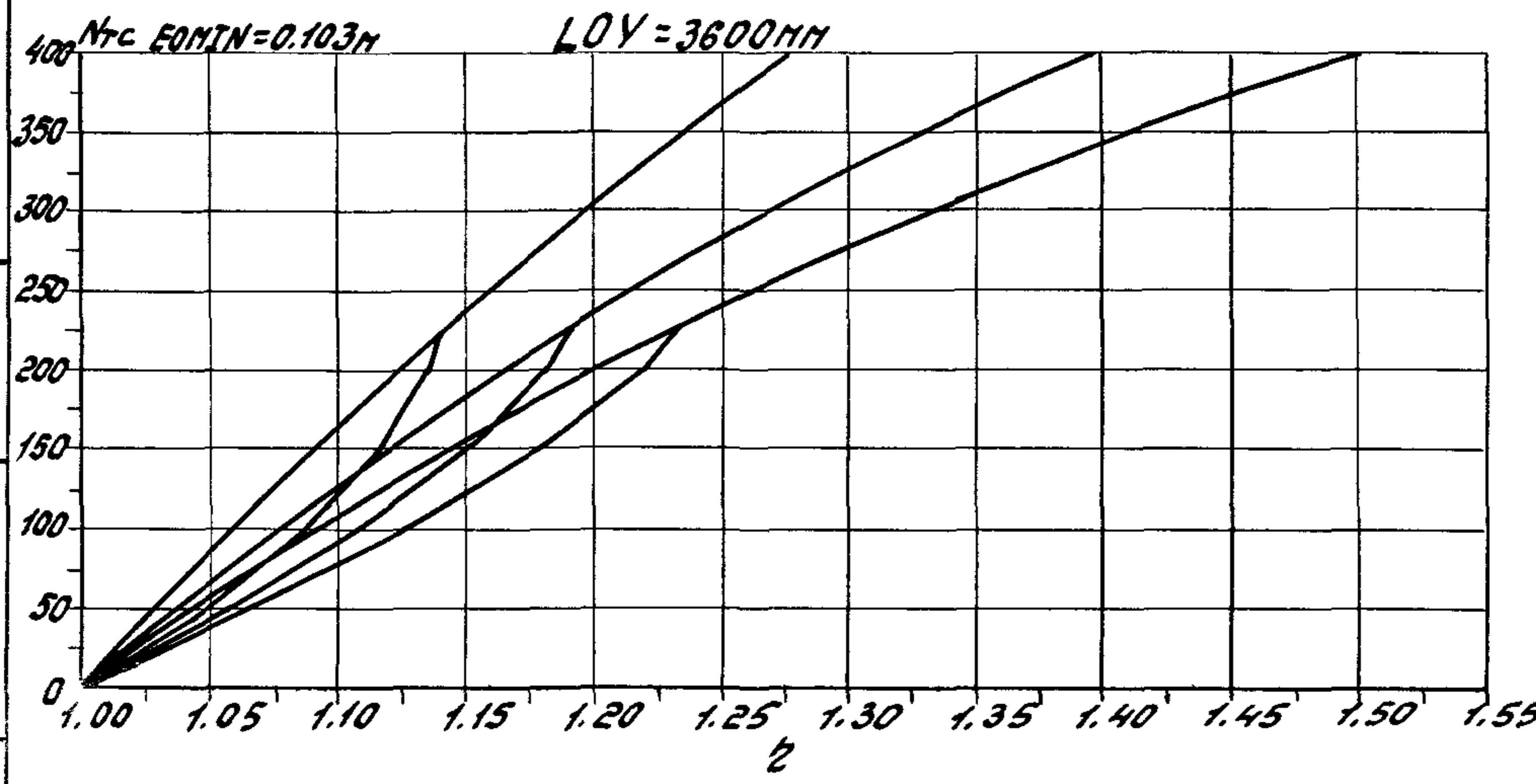
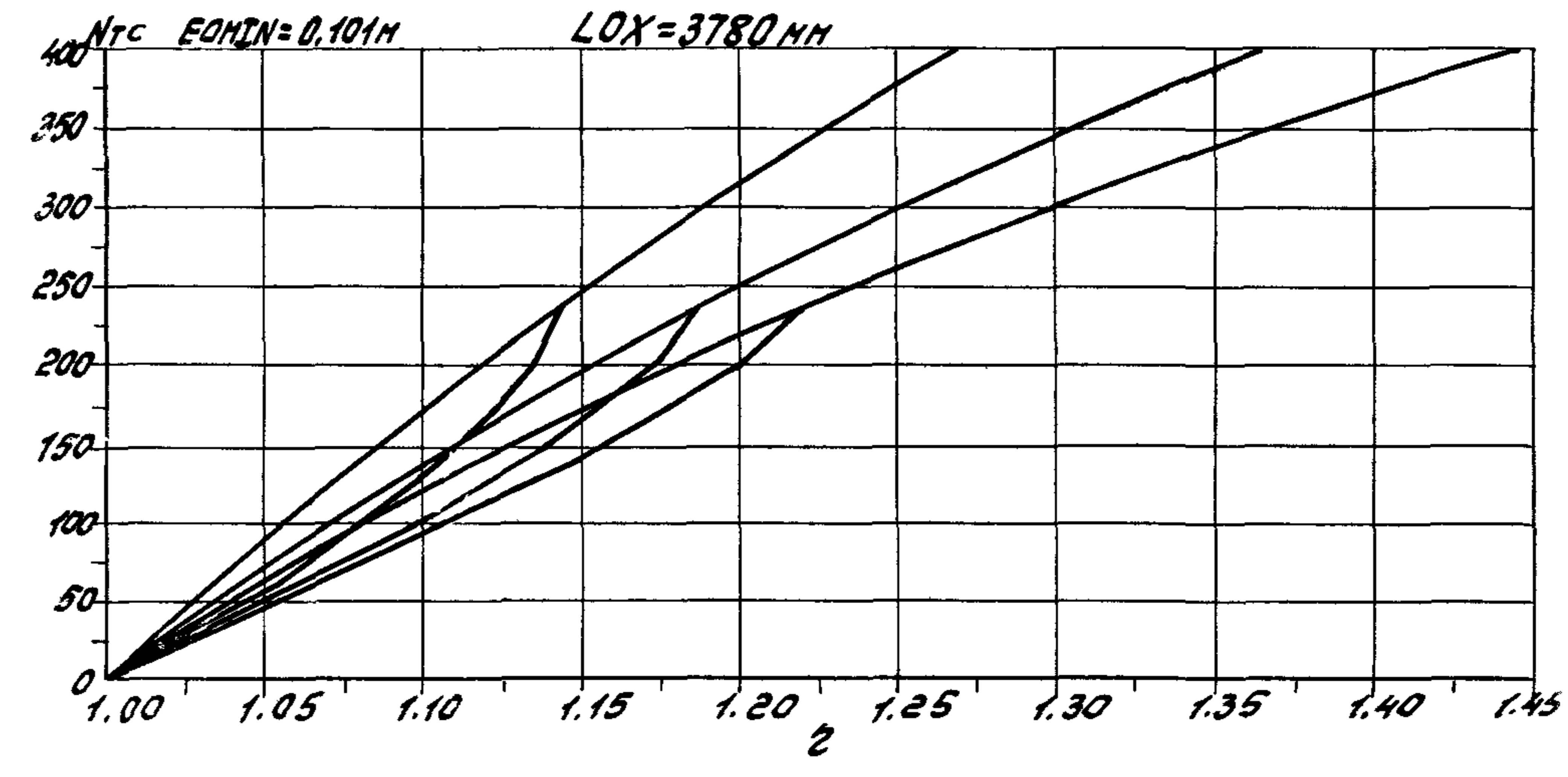
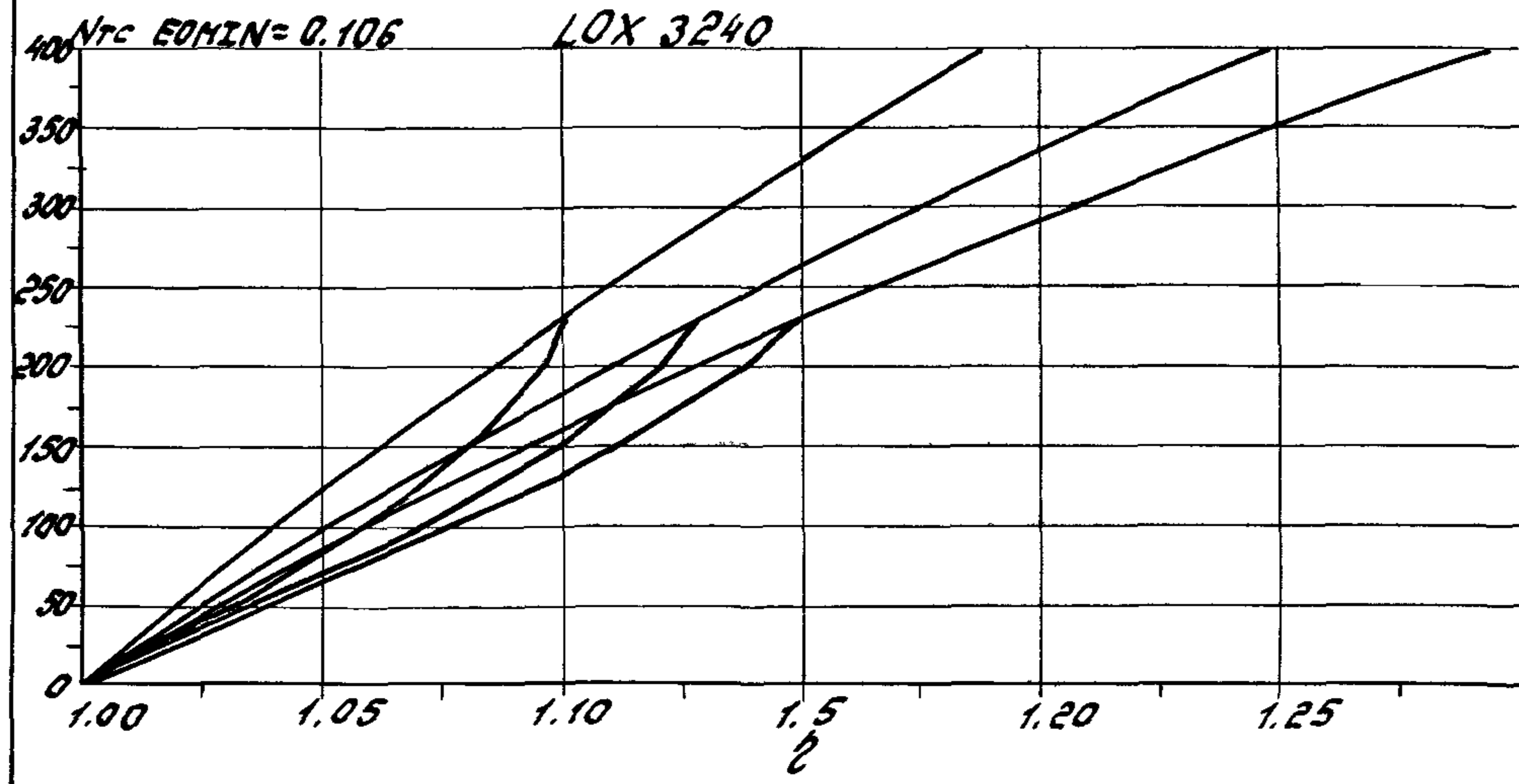

Инв. № подл. Подпись и дата выдачи инв. №

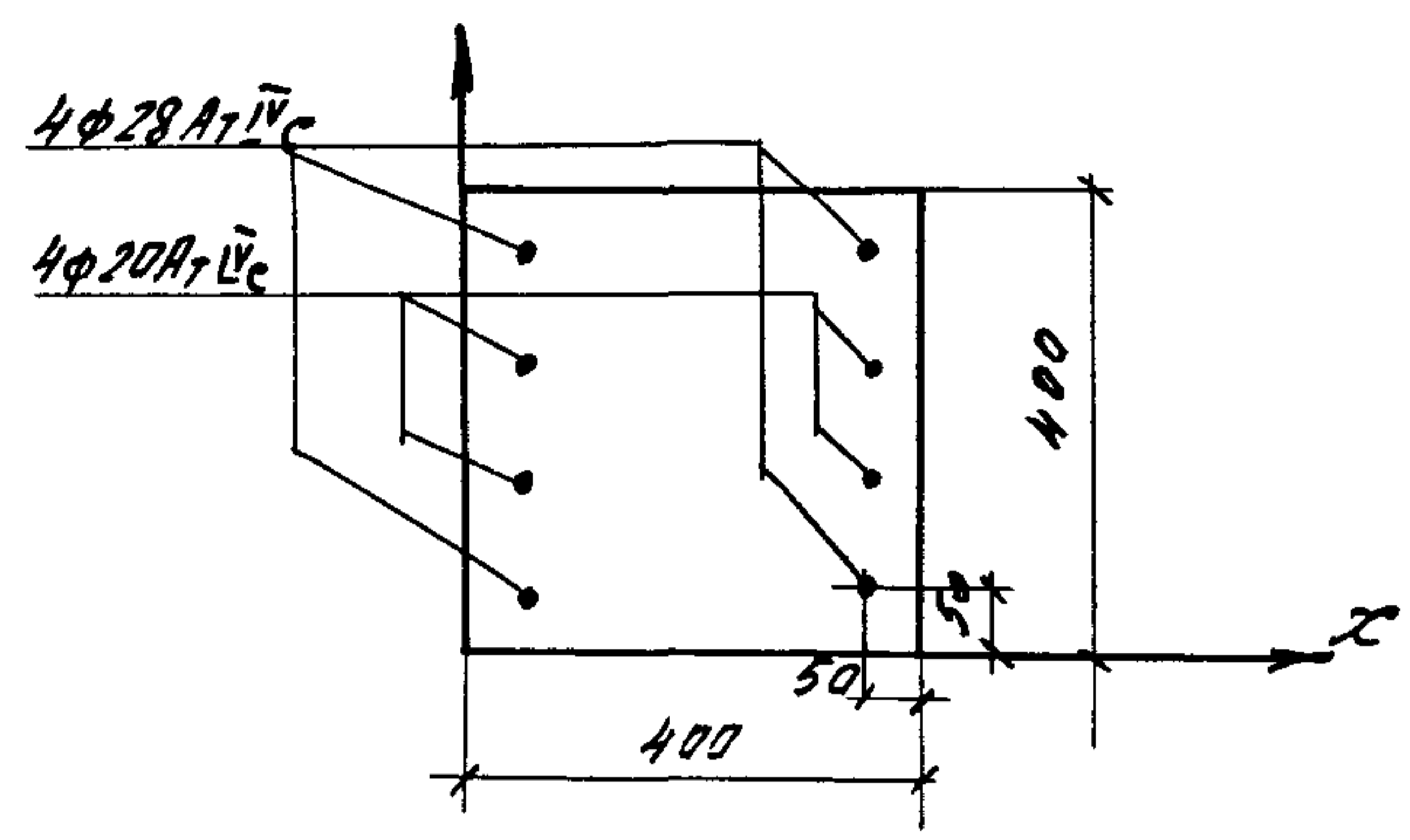
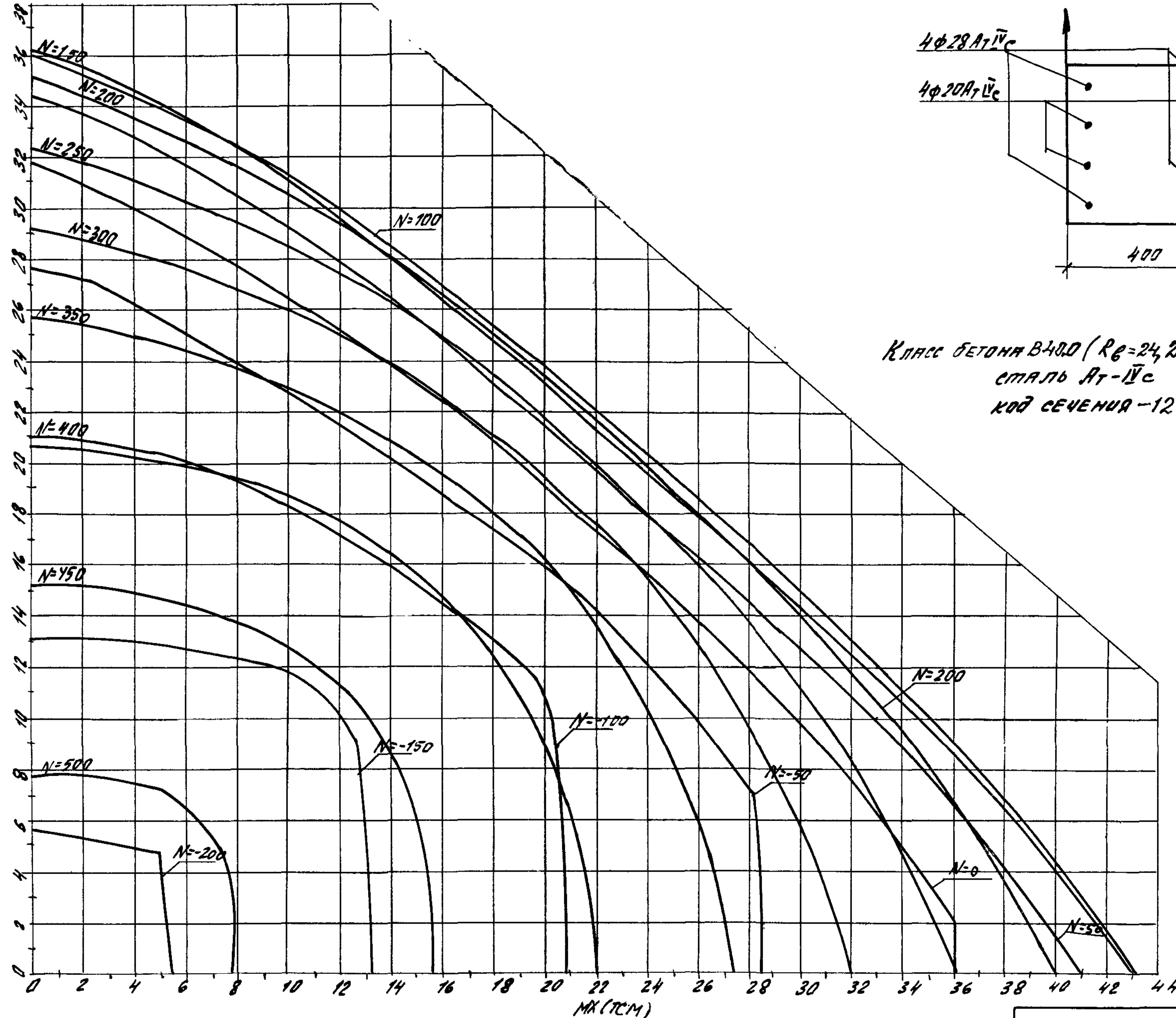

Класс бетона В40.0 ($R_b = 24,2$ МПа при учете $\gamma_{b2} = 1,10$)
 сталь А7-IIc
 код сечения - 127д

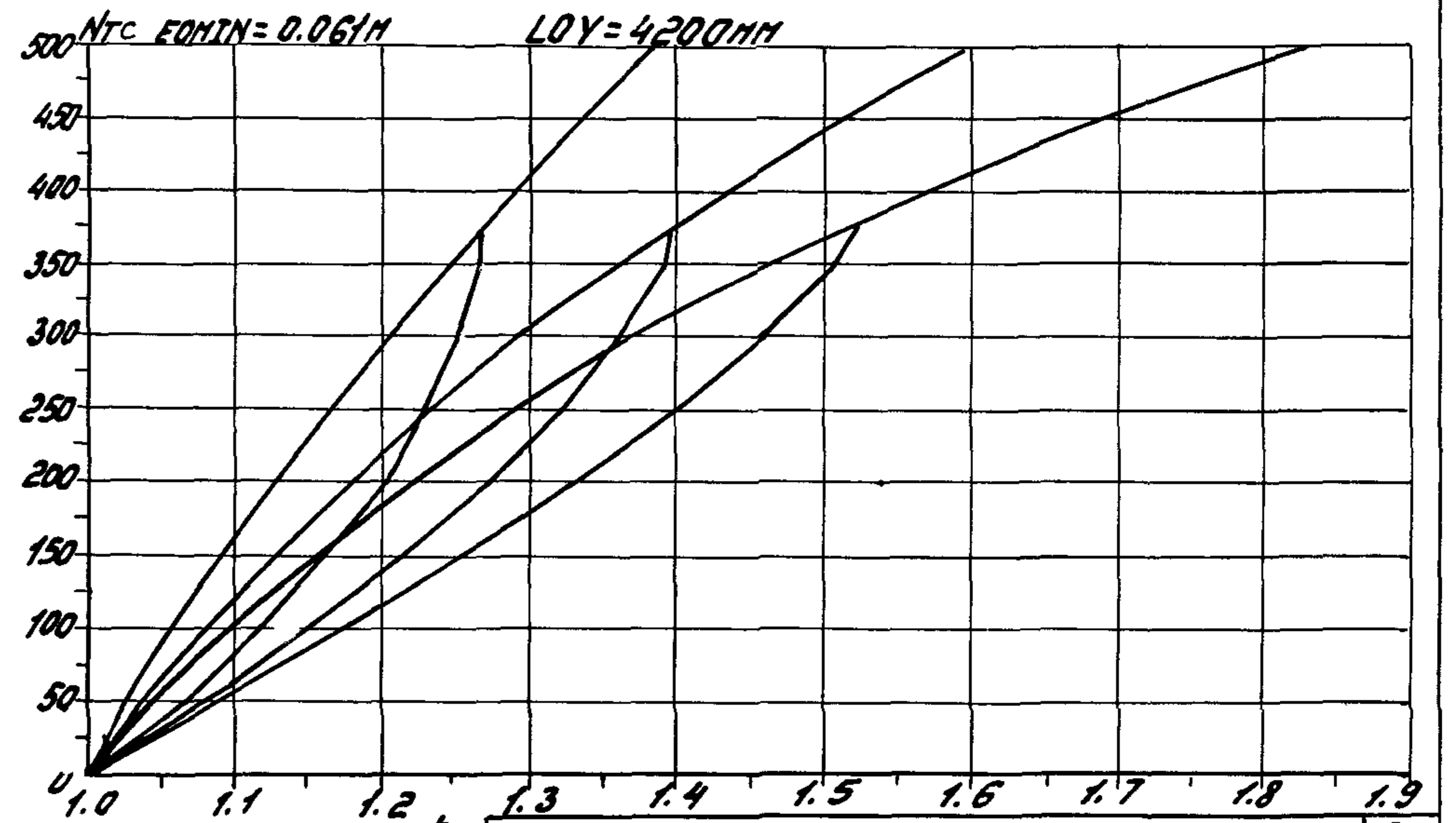
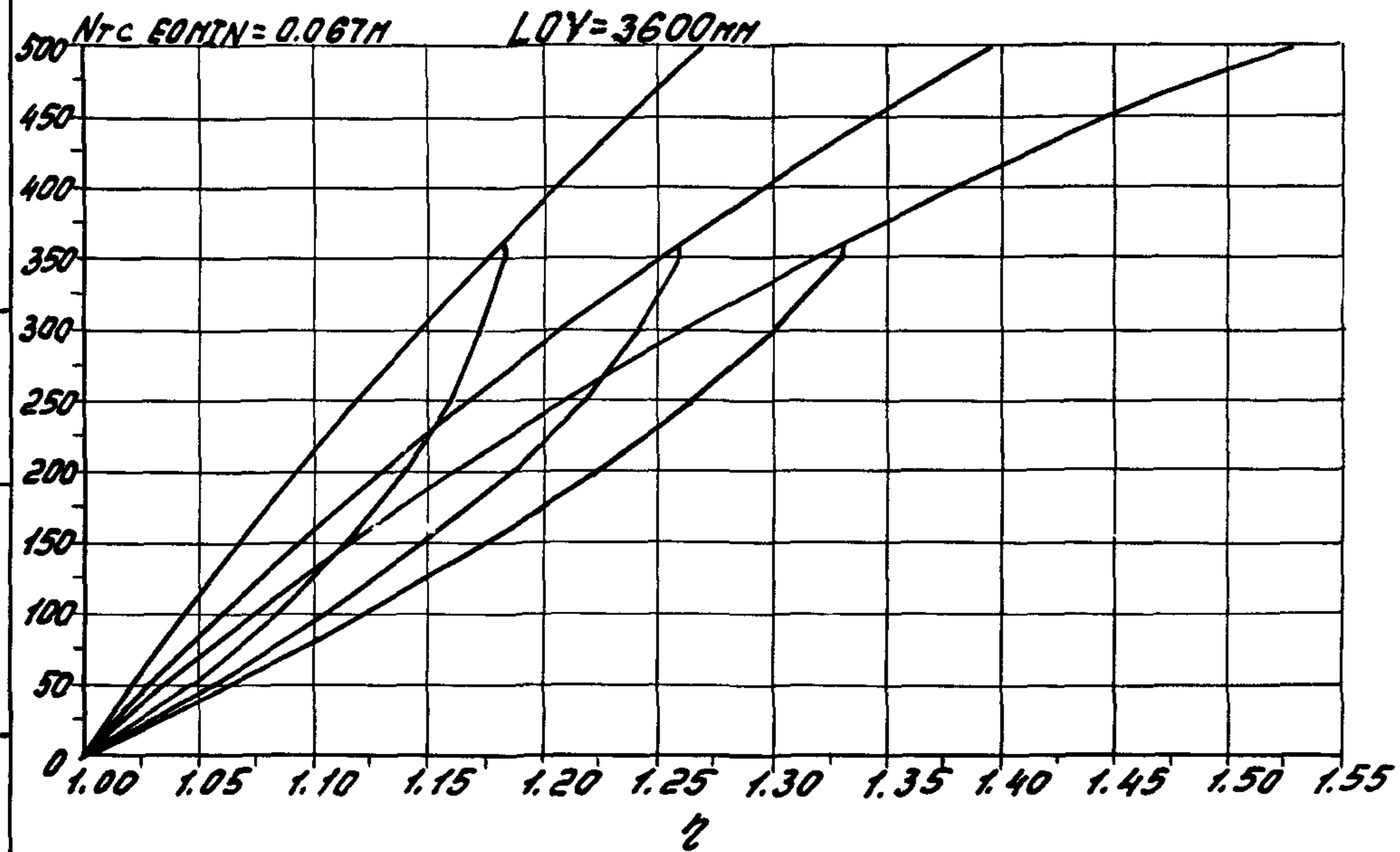
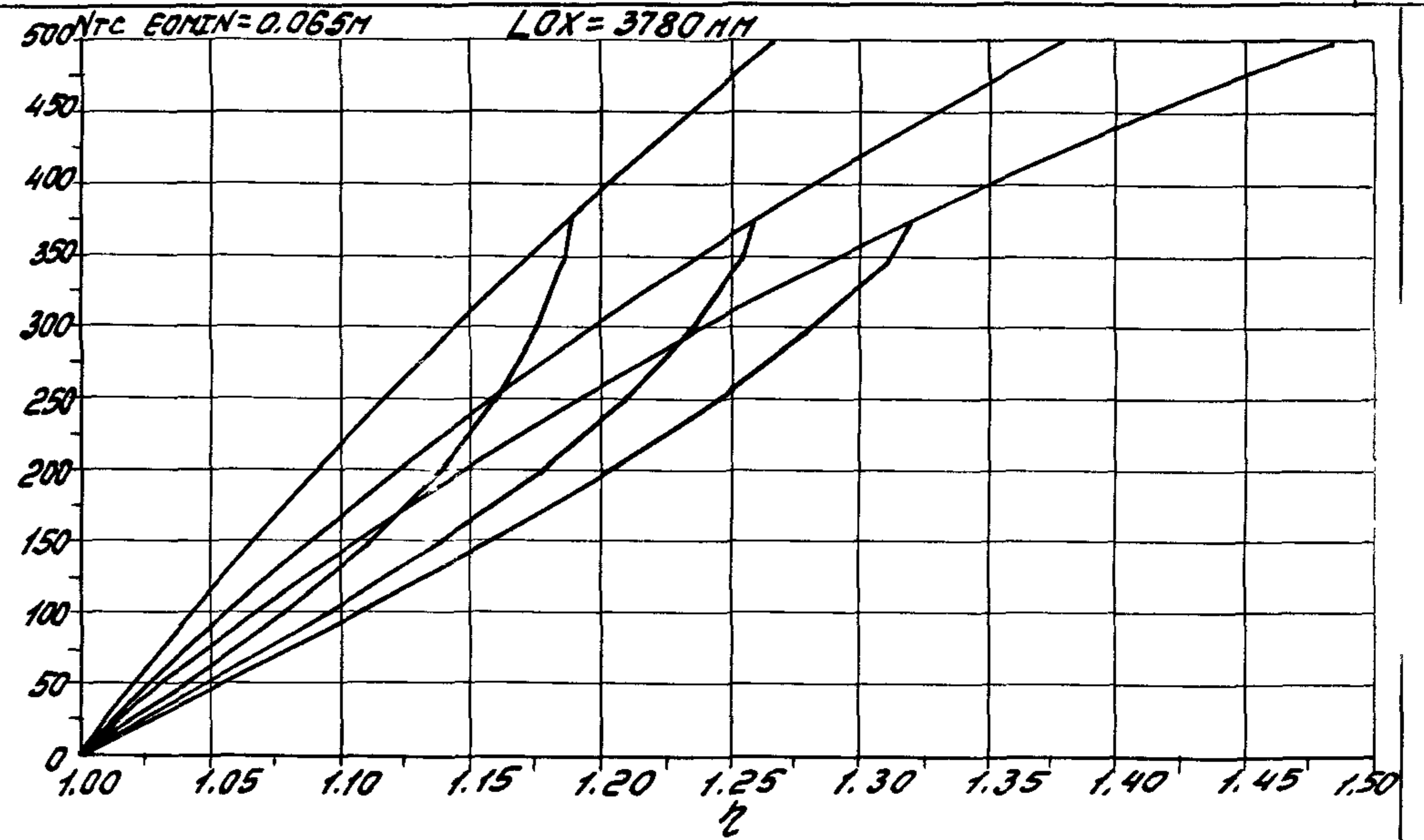
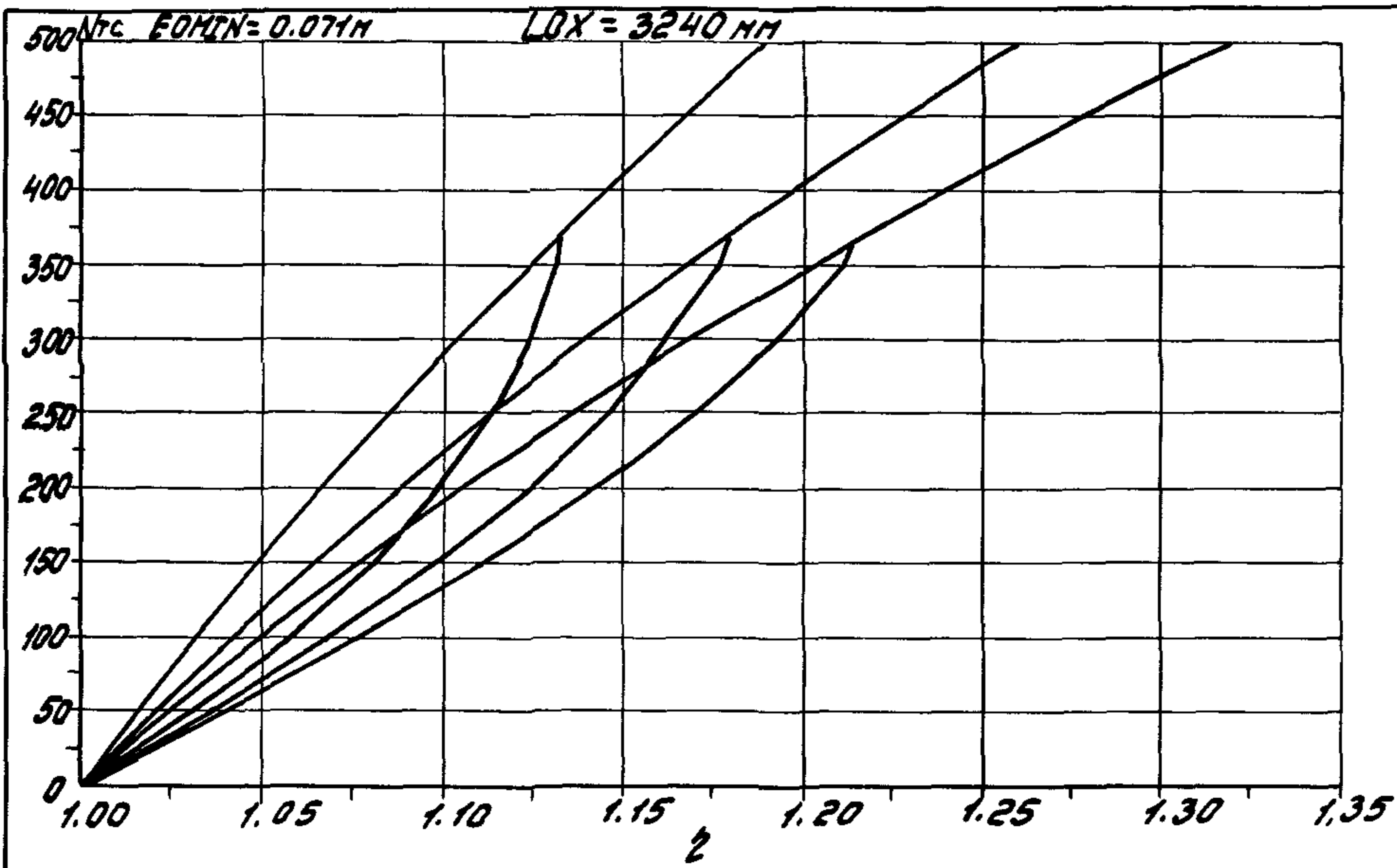

1.020.1-4 0-9 002

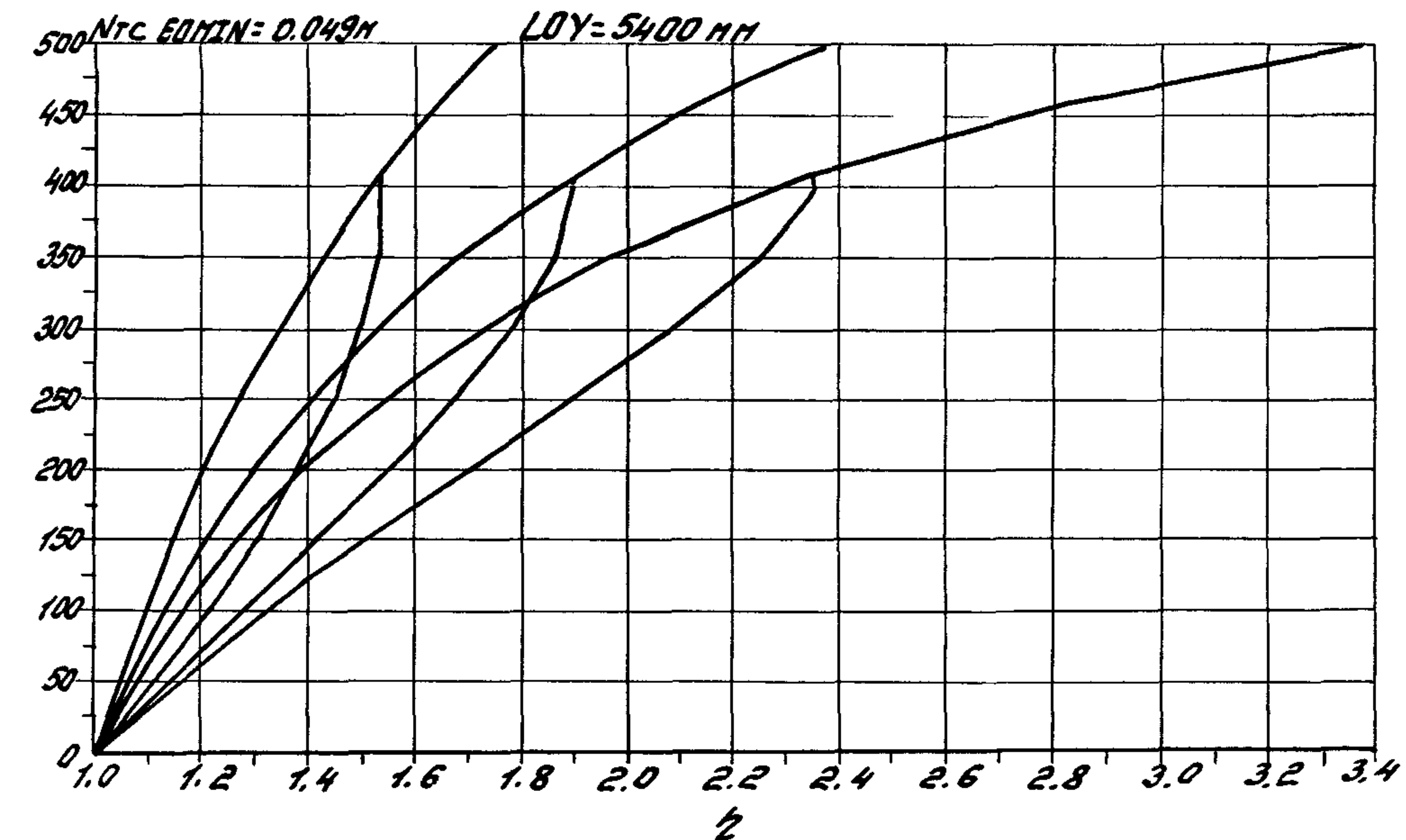
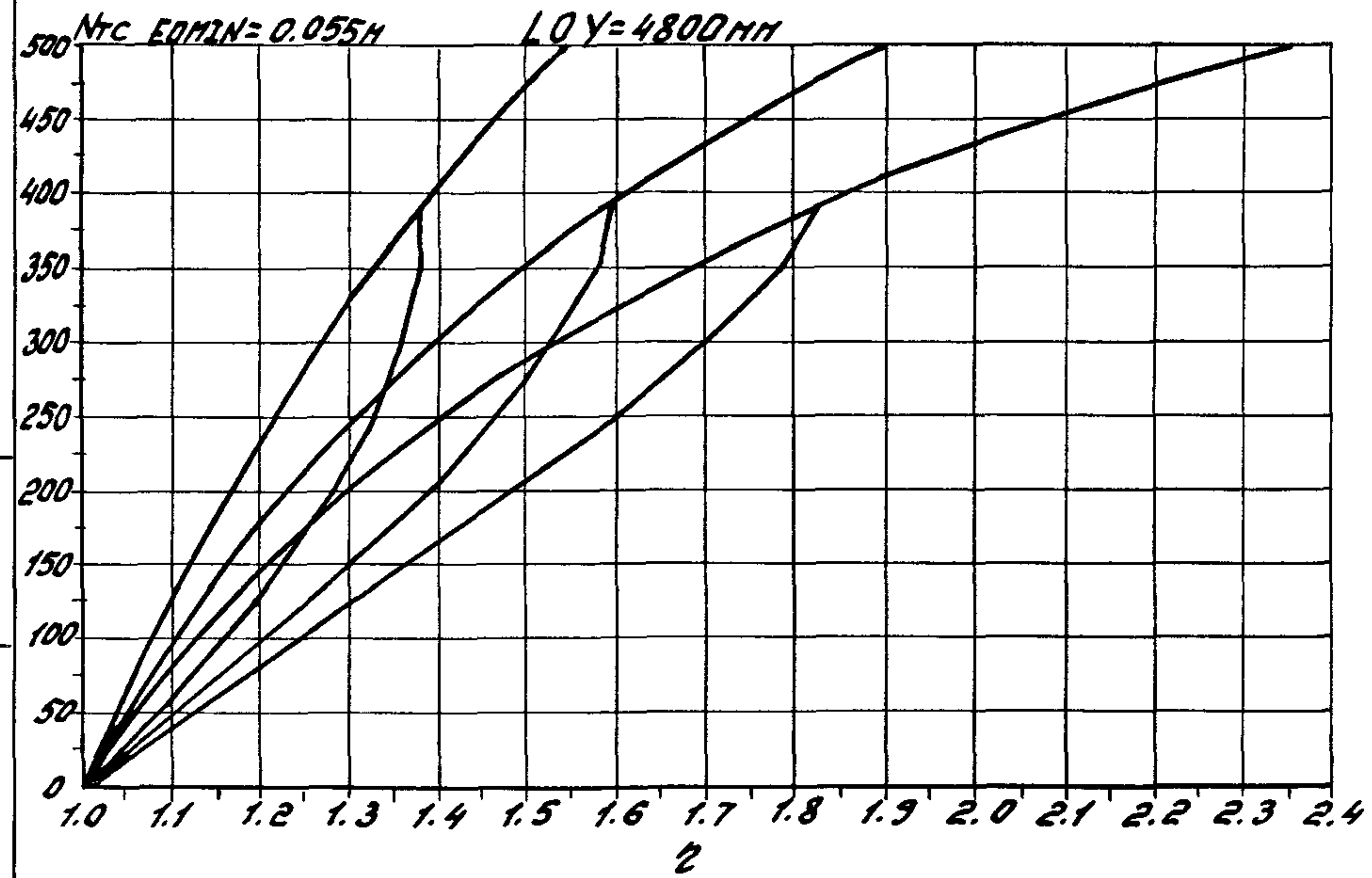
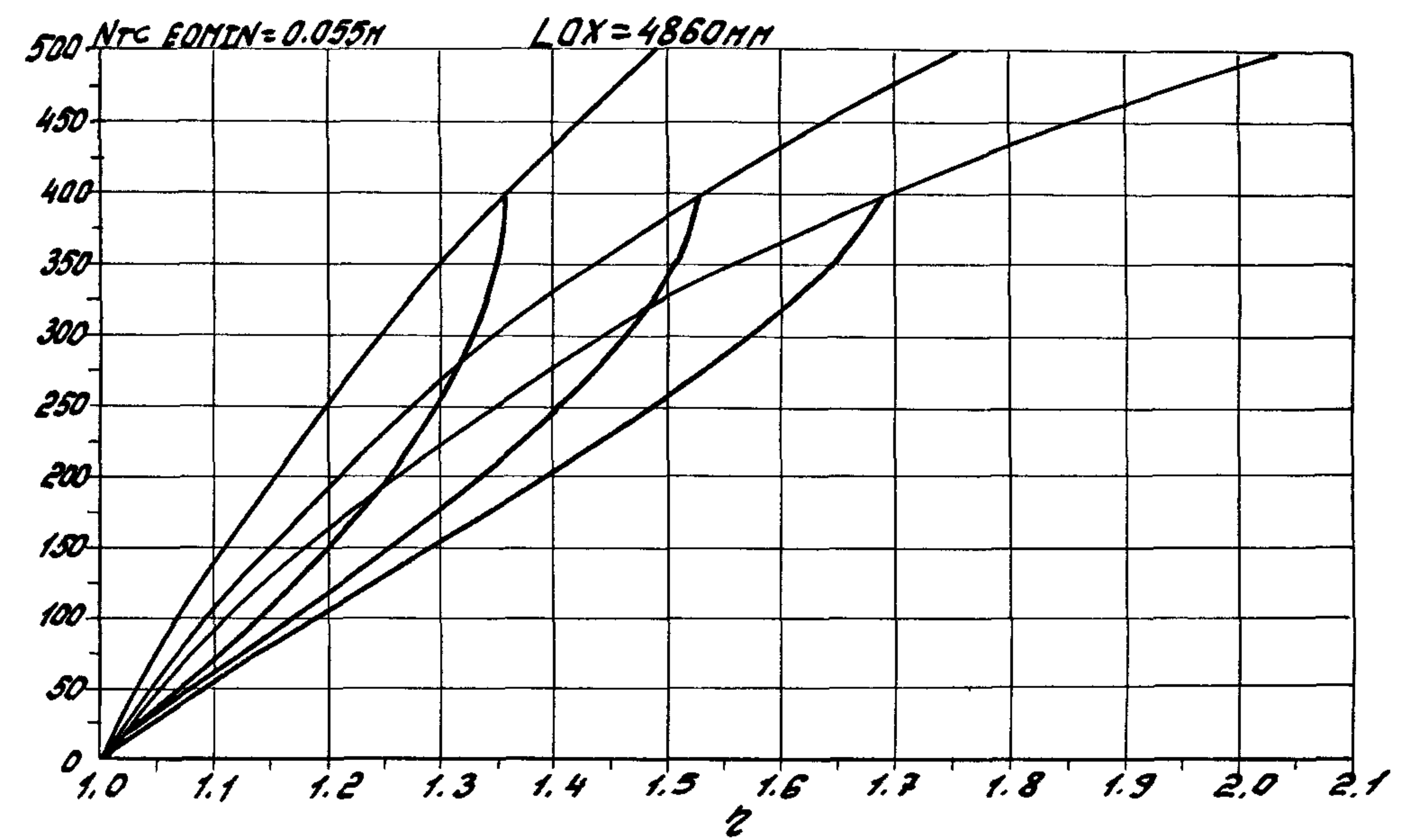
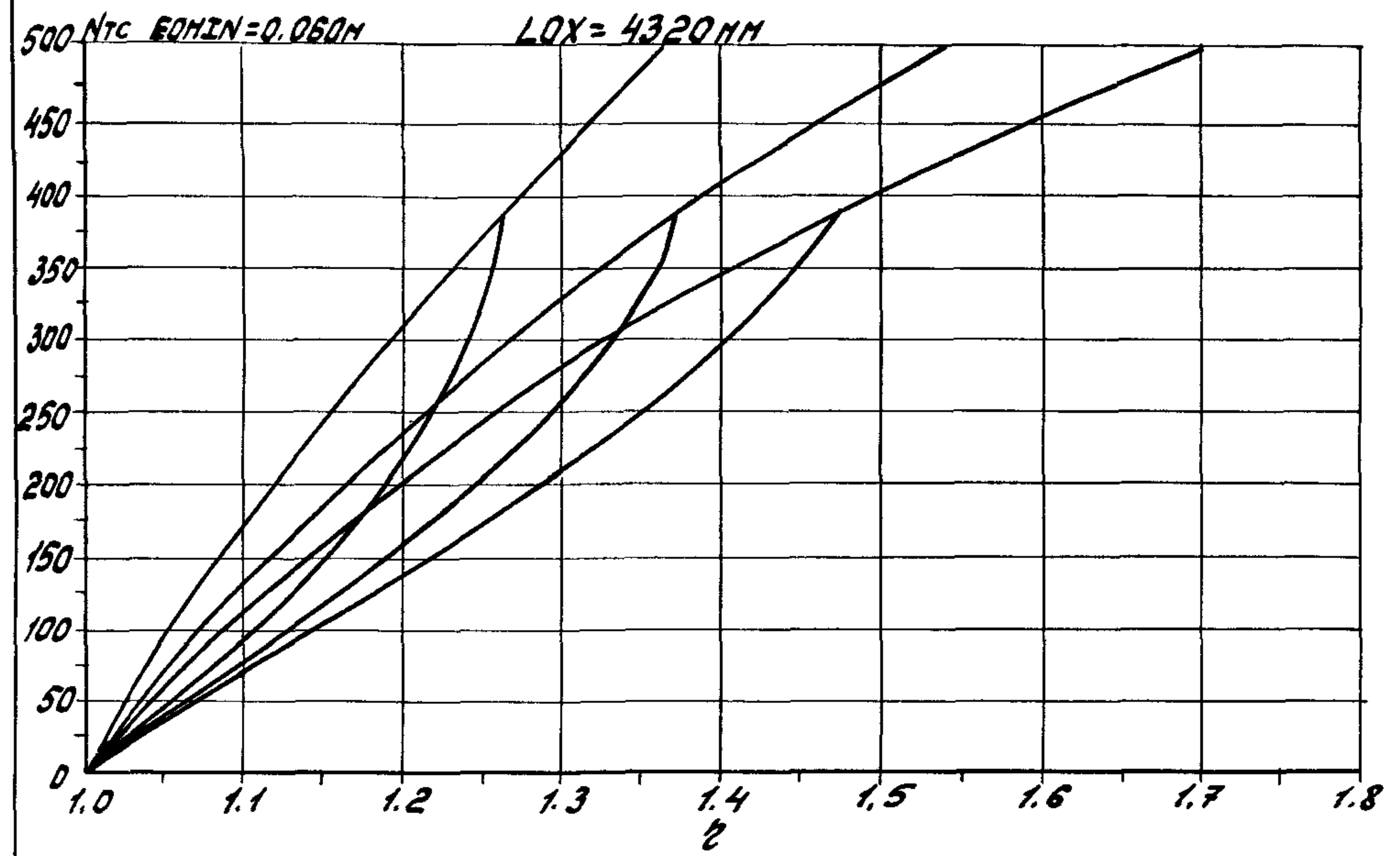

Учб. Нормал. и. Видеосъездотв. В.3071

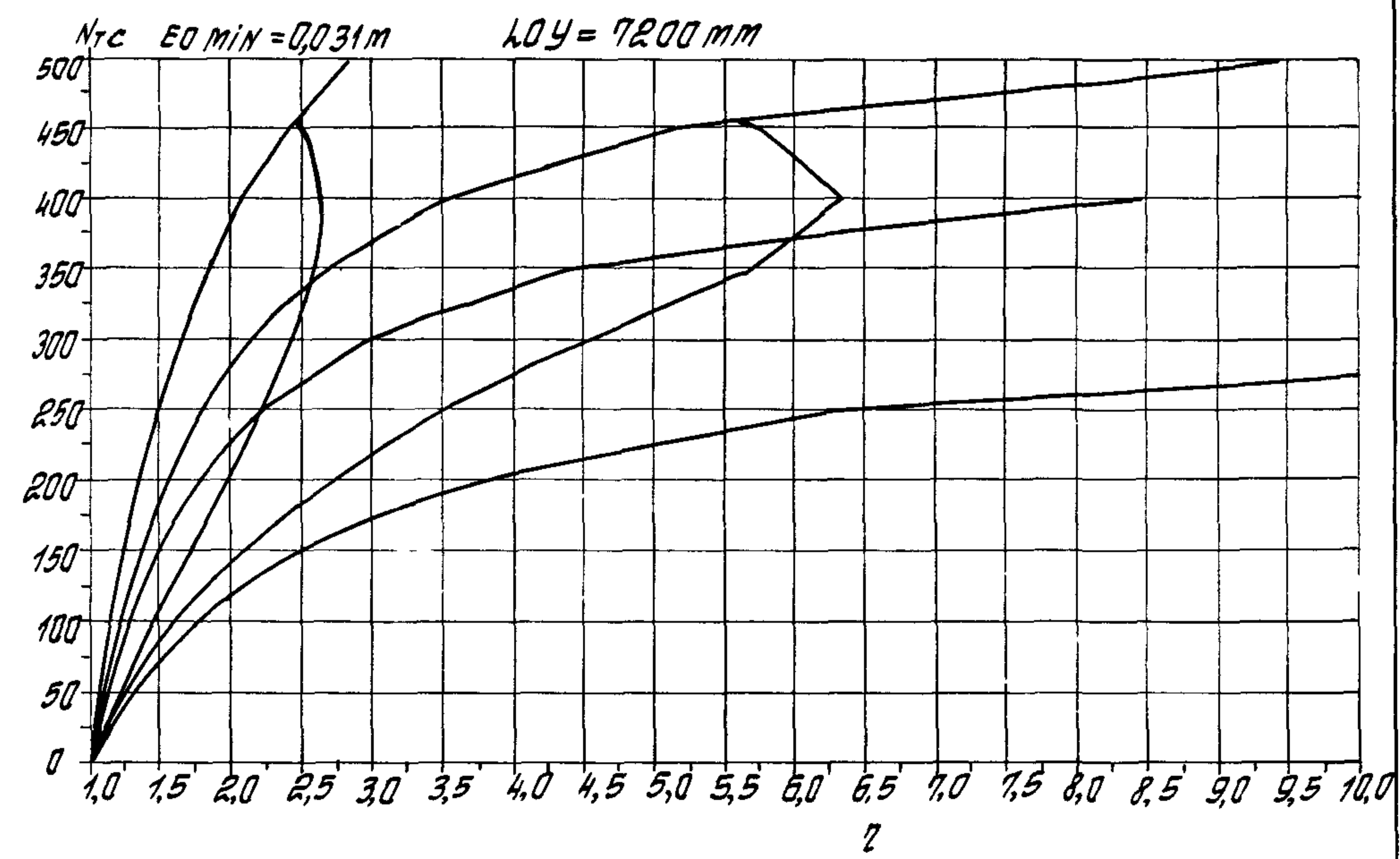
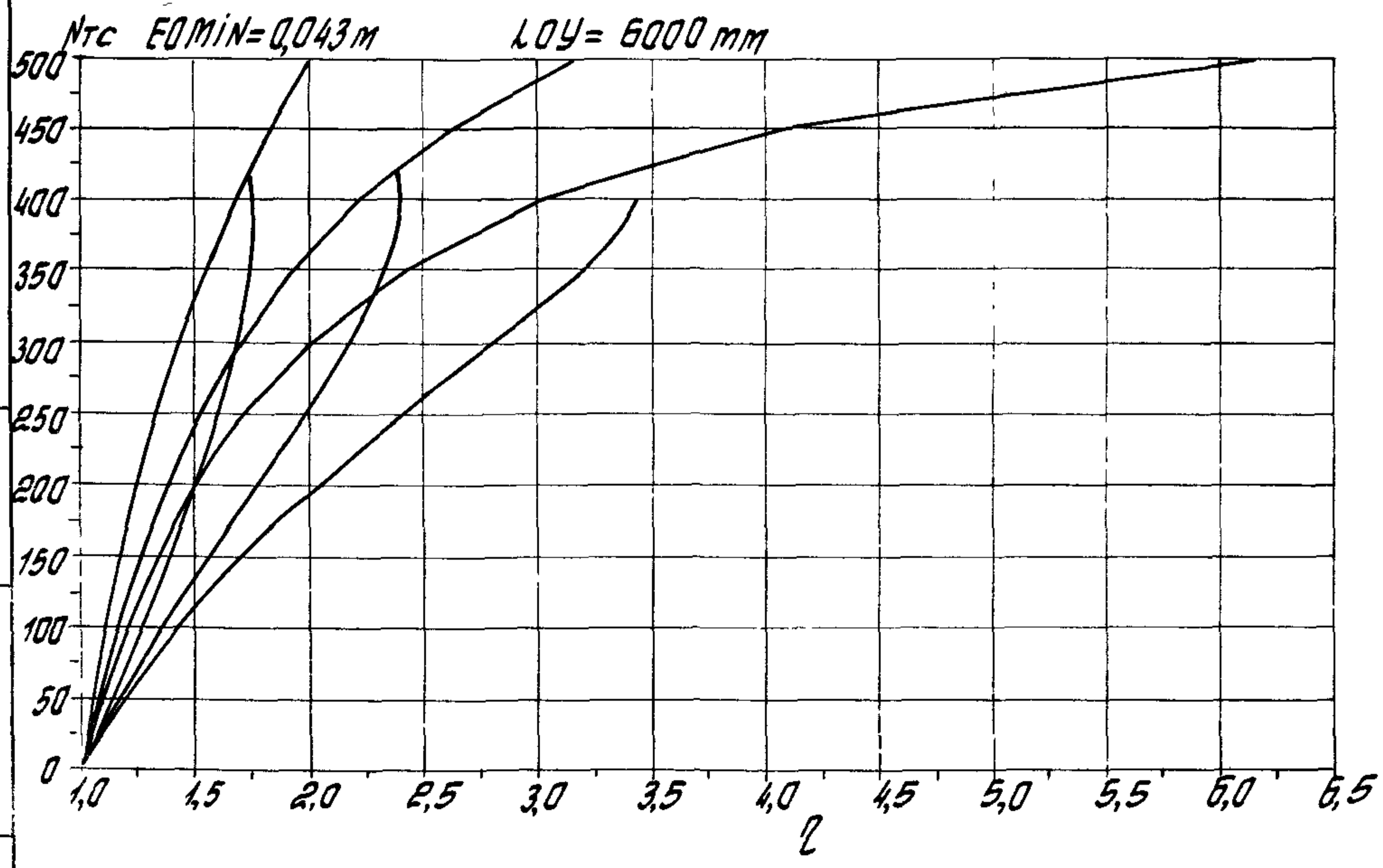
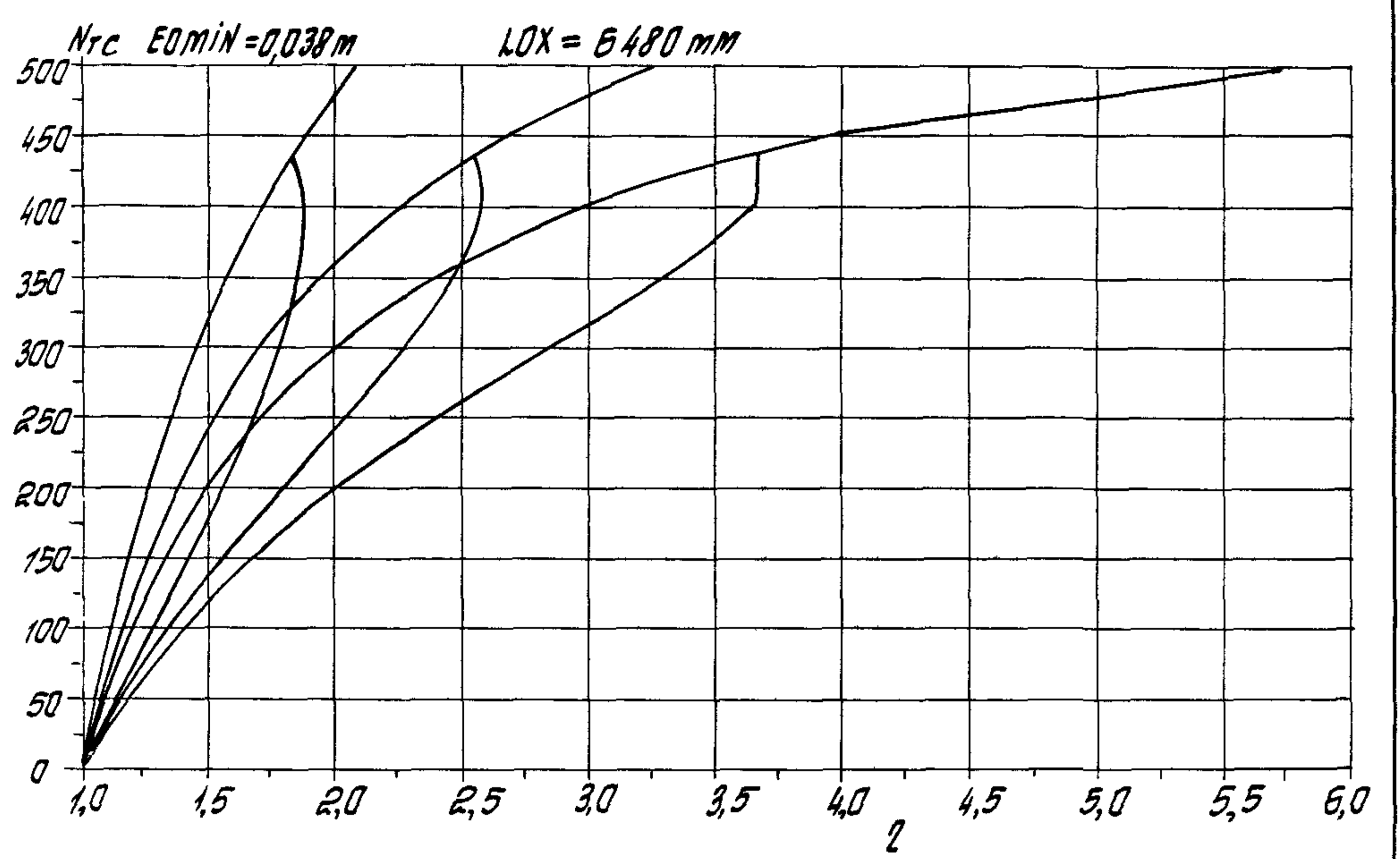
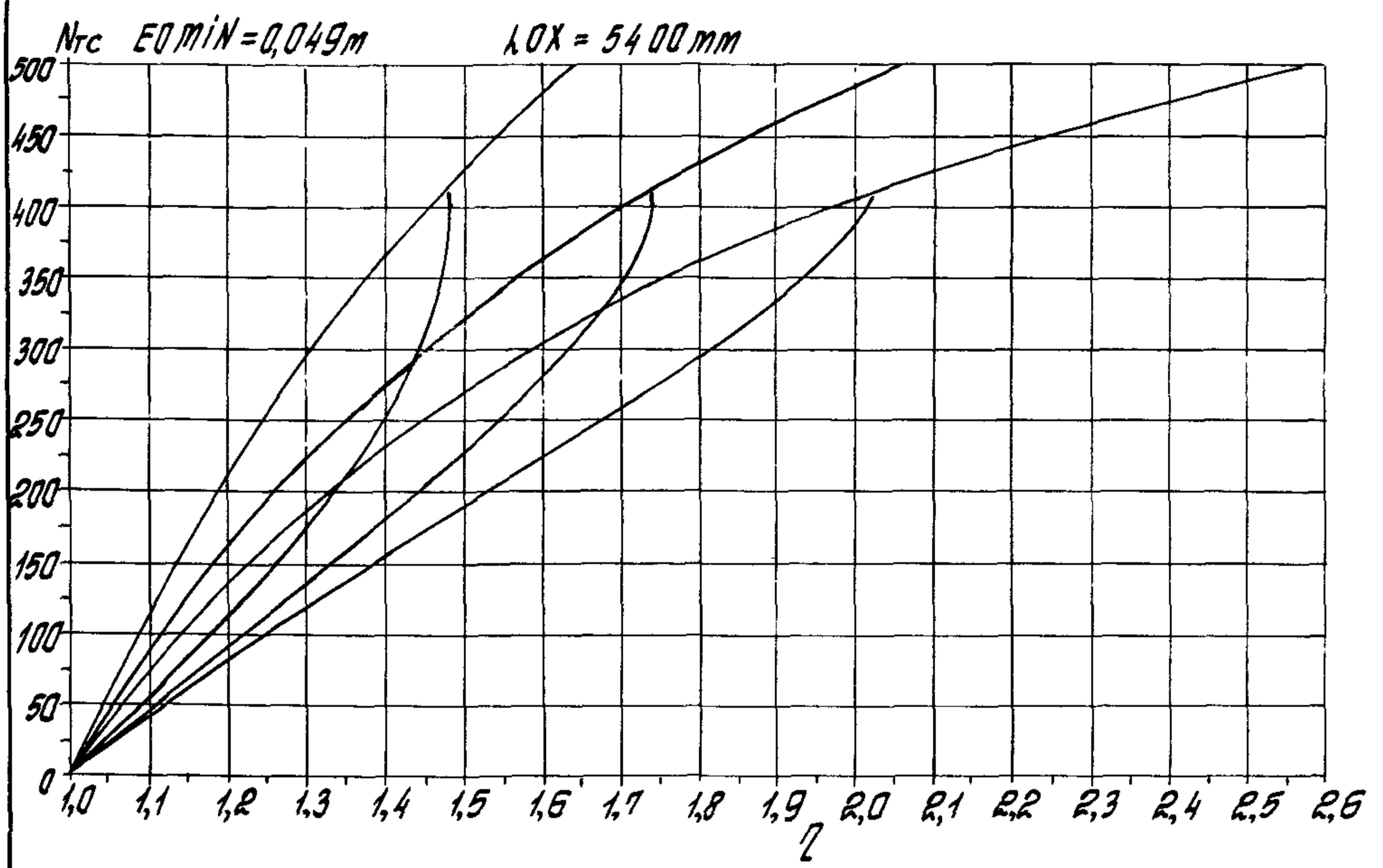

Лист № 1000. Институт Учен. Исслед. Академии Наук СССР

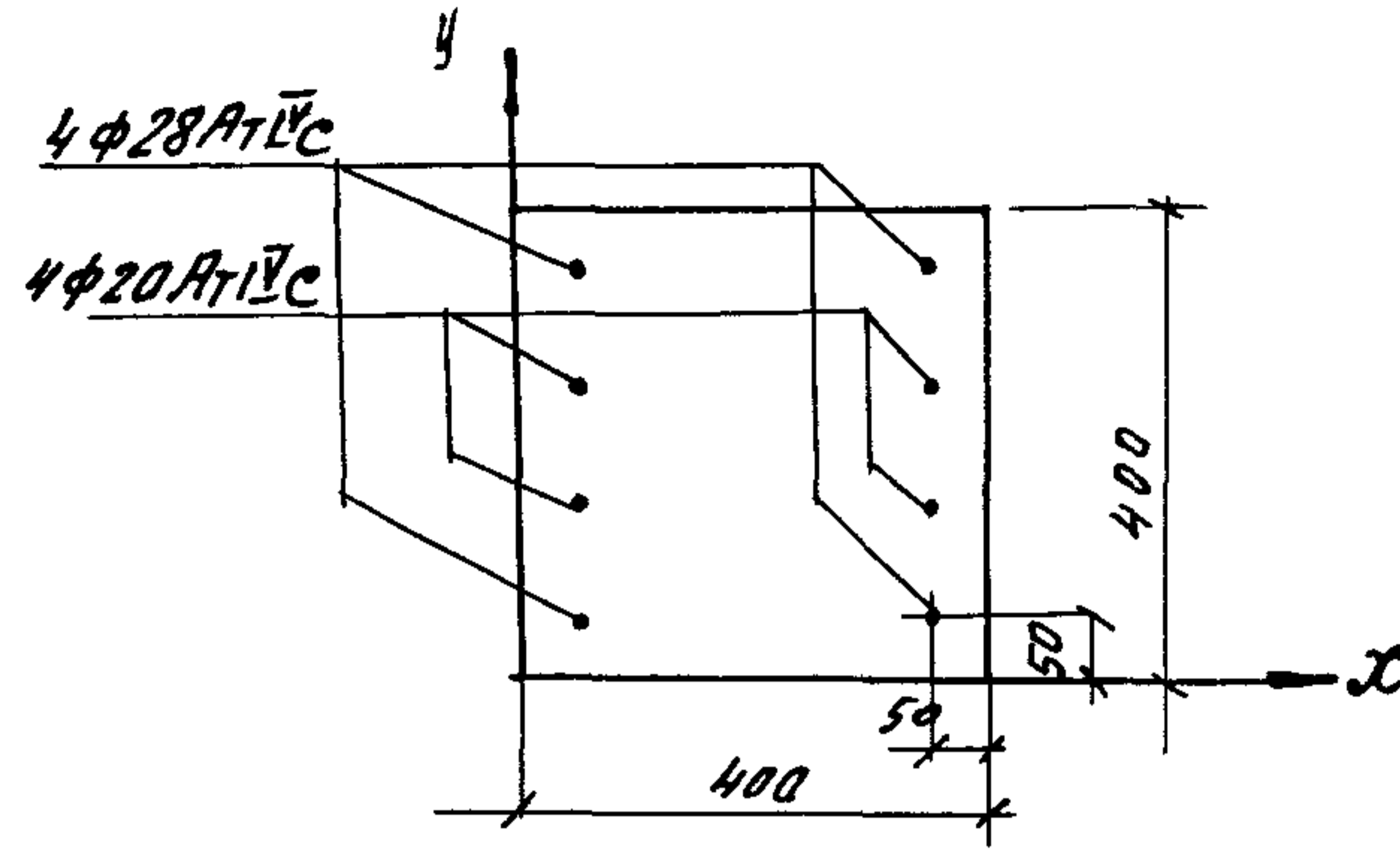
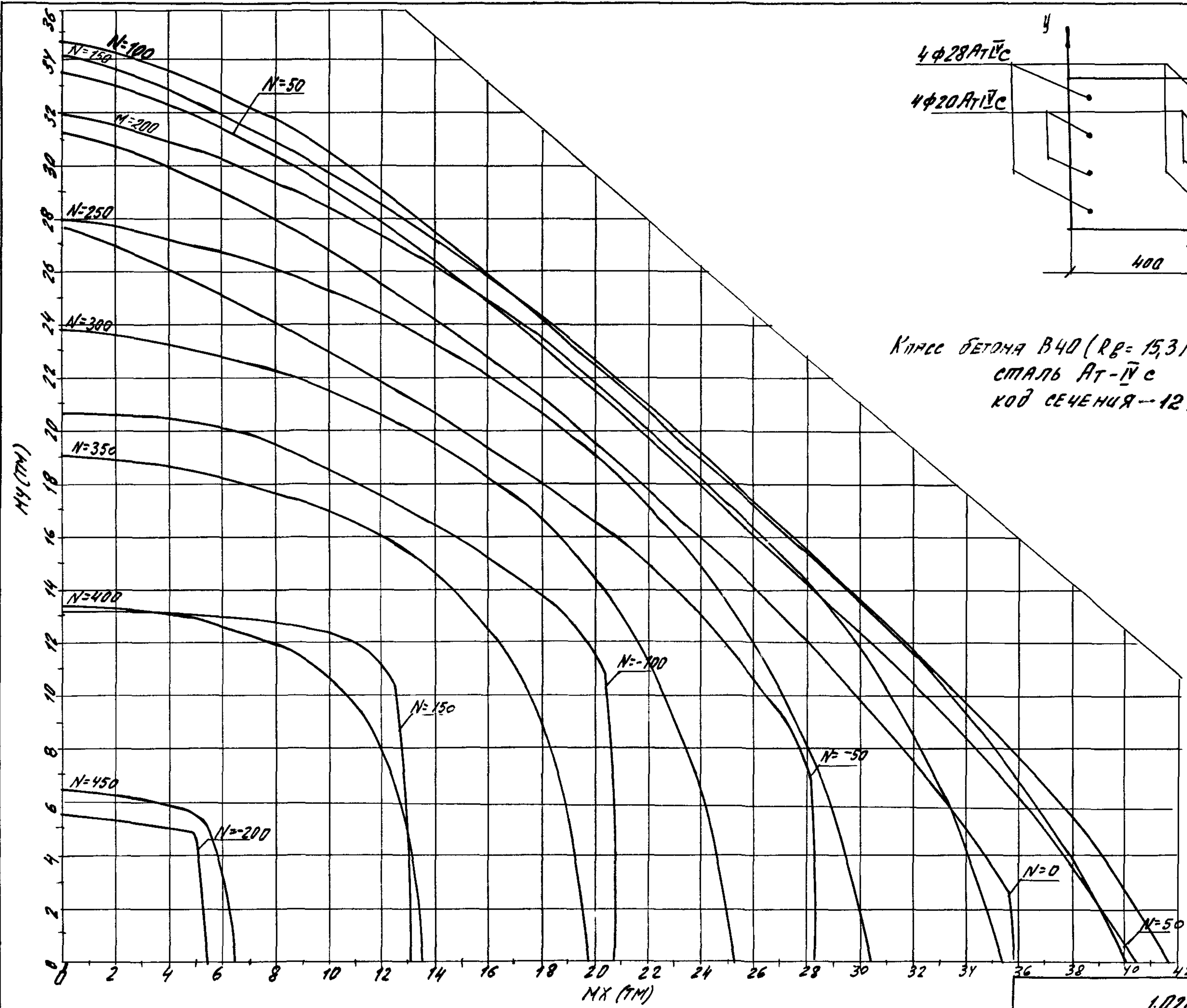

Класс бетона В40 ($R_B = 15,3 \text{ МПа}$ при учете $\gamma_{B2} = 0,90$)
 сталь А1-IV с
 код сечения -- 1278

1:2 № 100/11-12-13-14-15-16-17-18-19-20-21-22-23-24-25-26-27-28-29-30-31-32-33-34-35-36-37-38-39-40-41-42

1.020.1-4 0-9 002

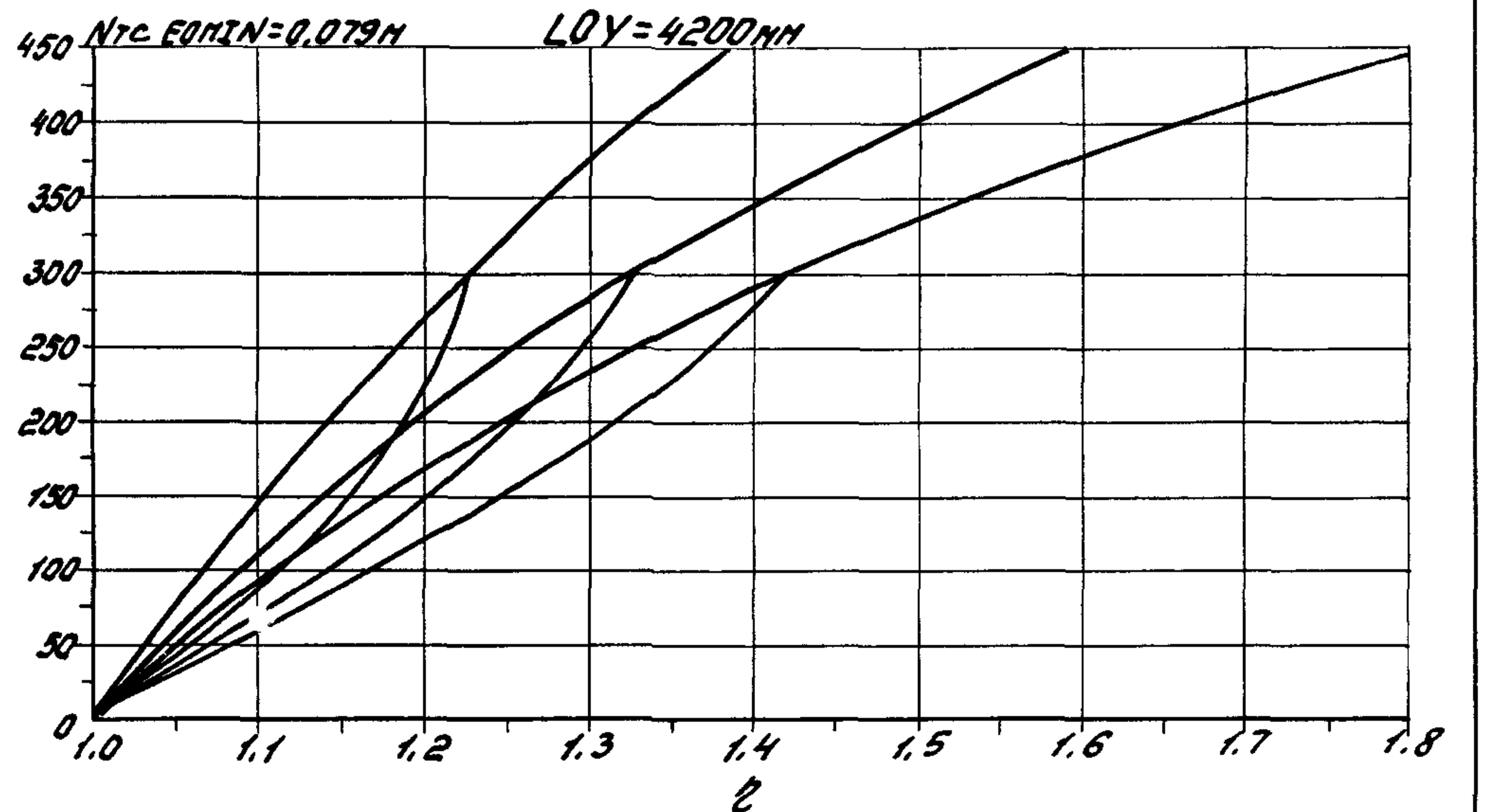
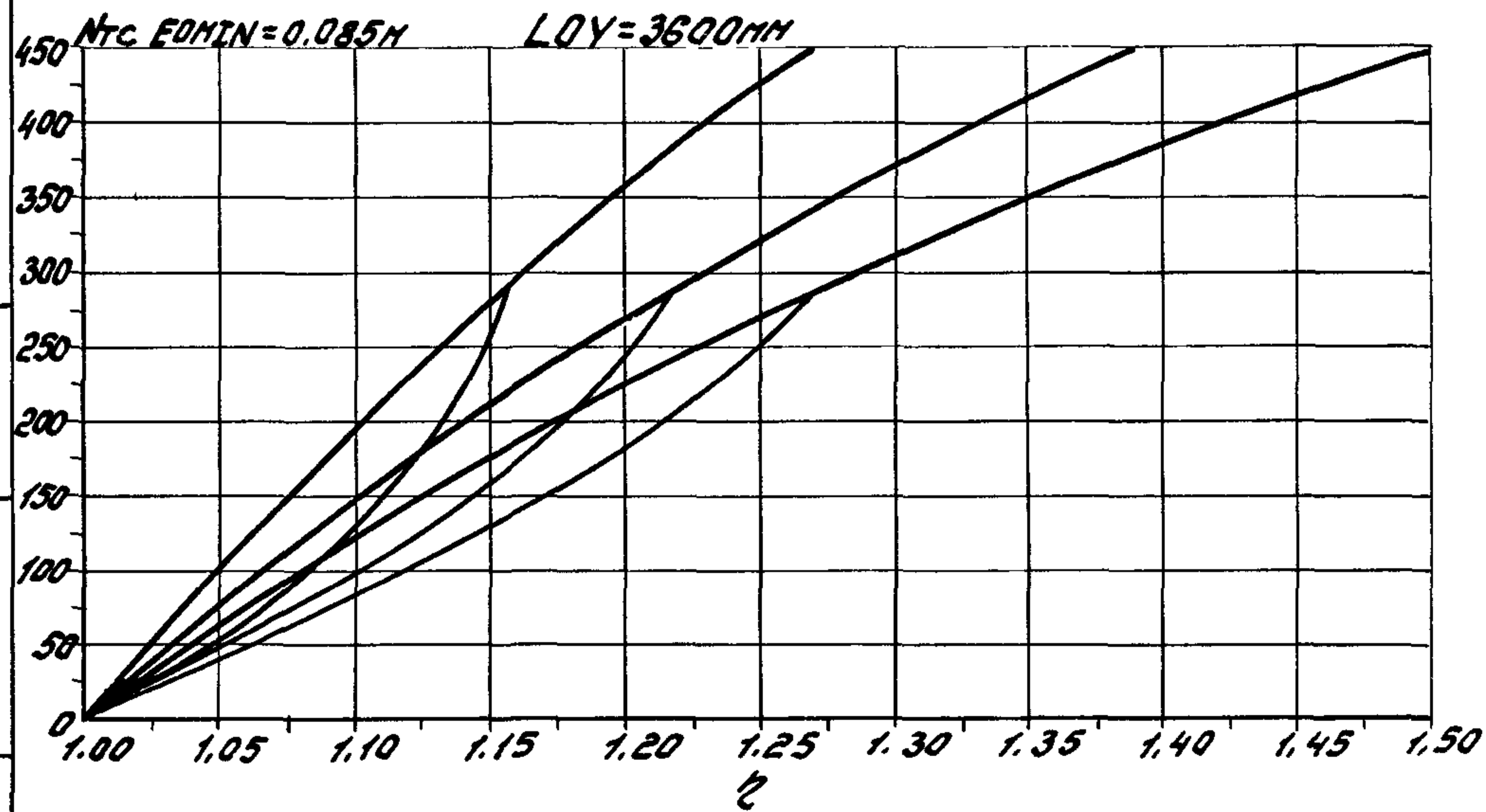
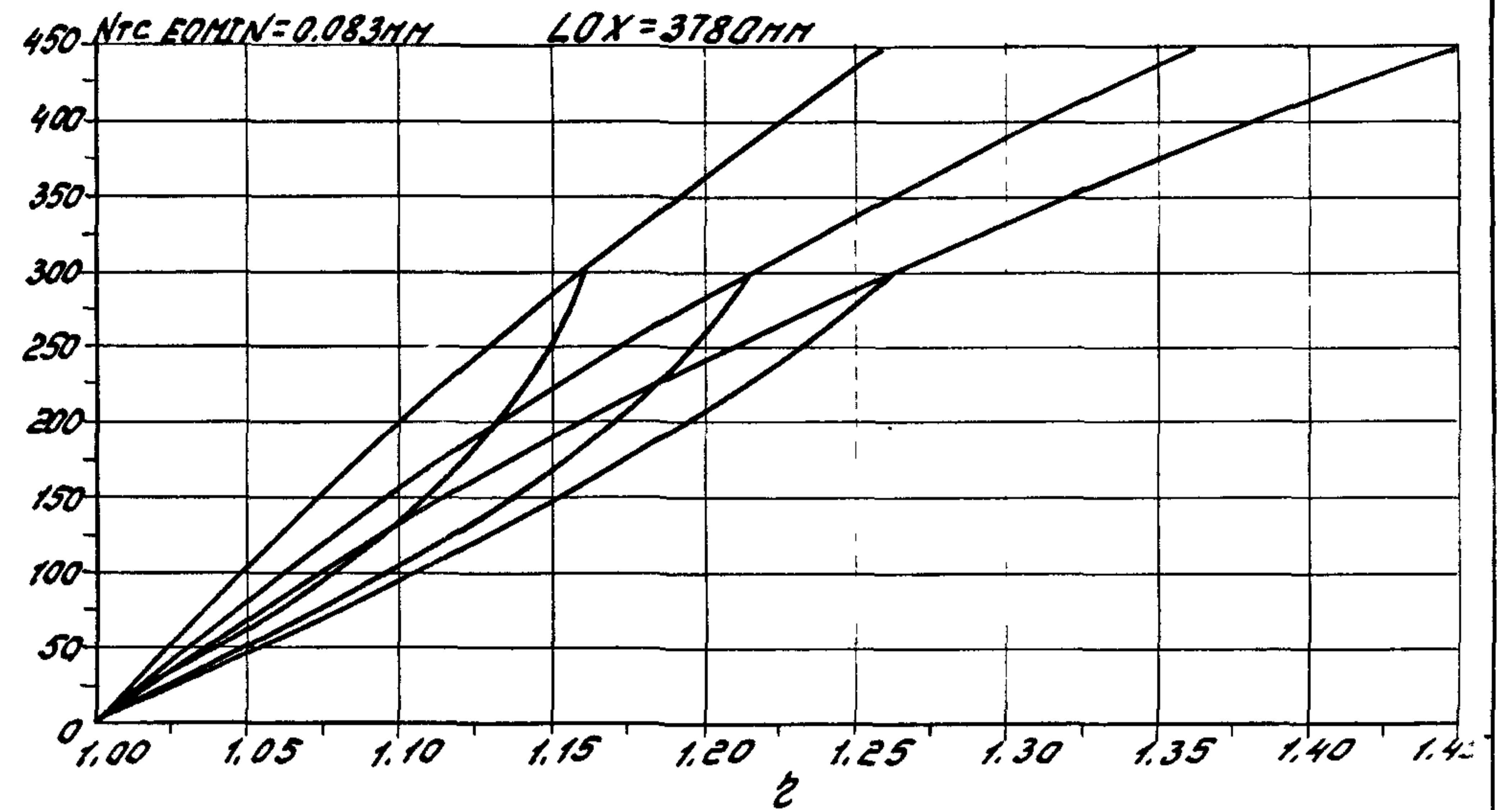
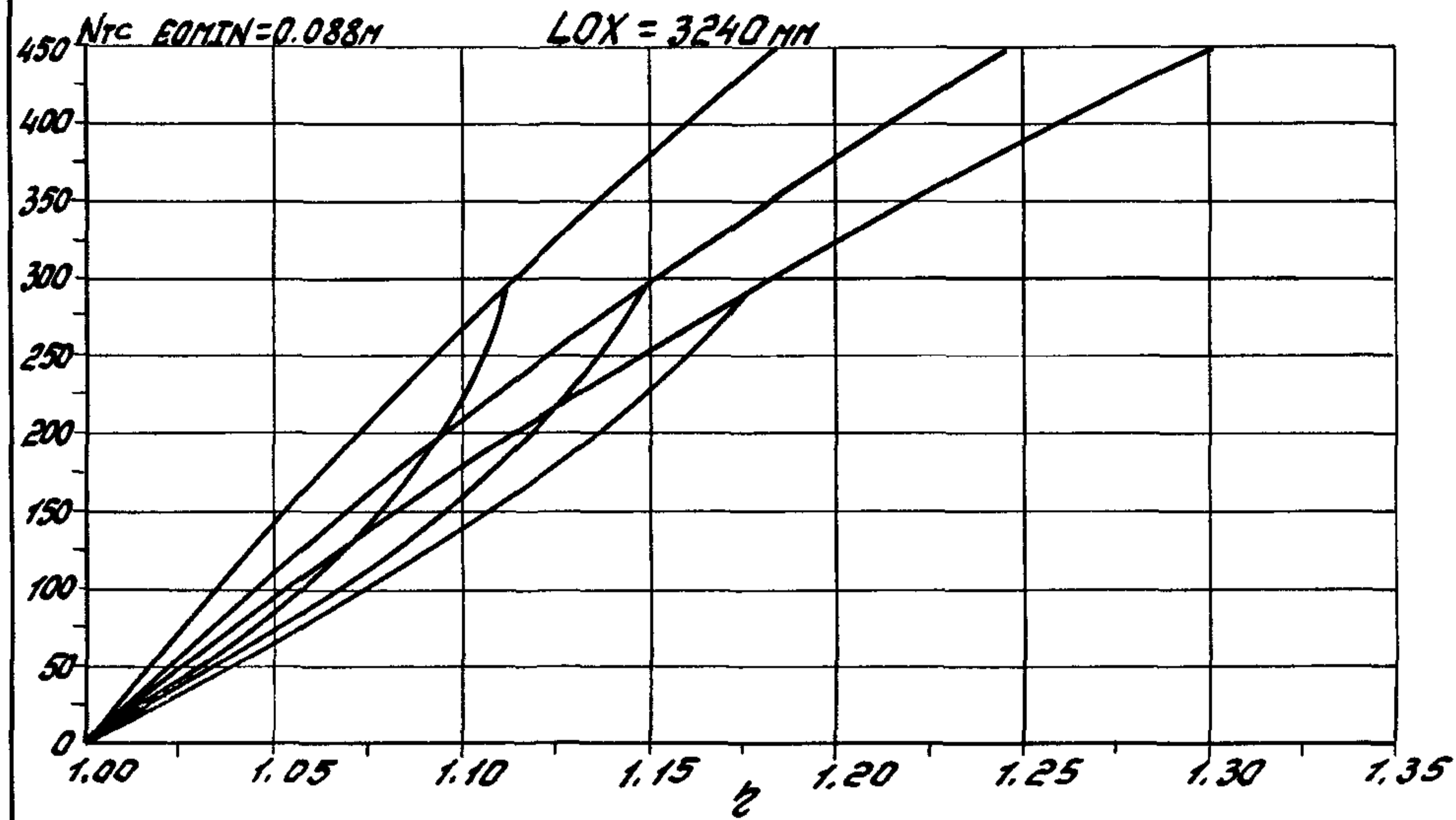

Инв. и подл. Подпись и дата ВЗНП. ИИВ.М

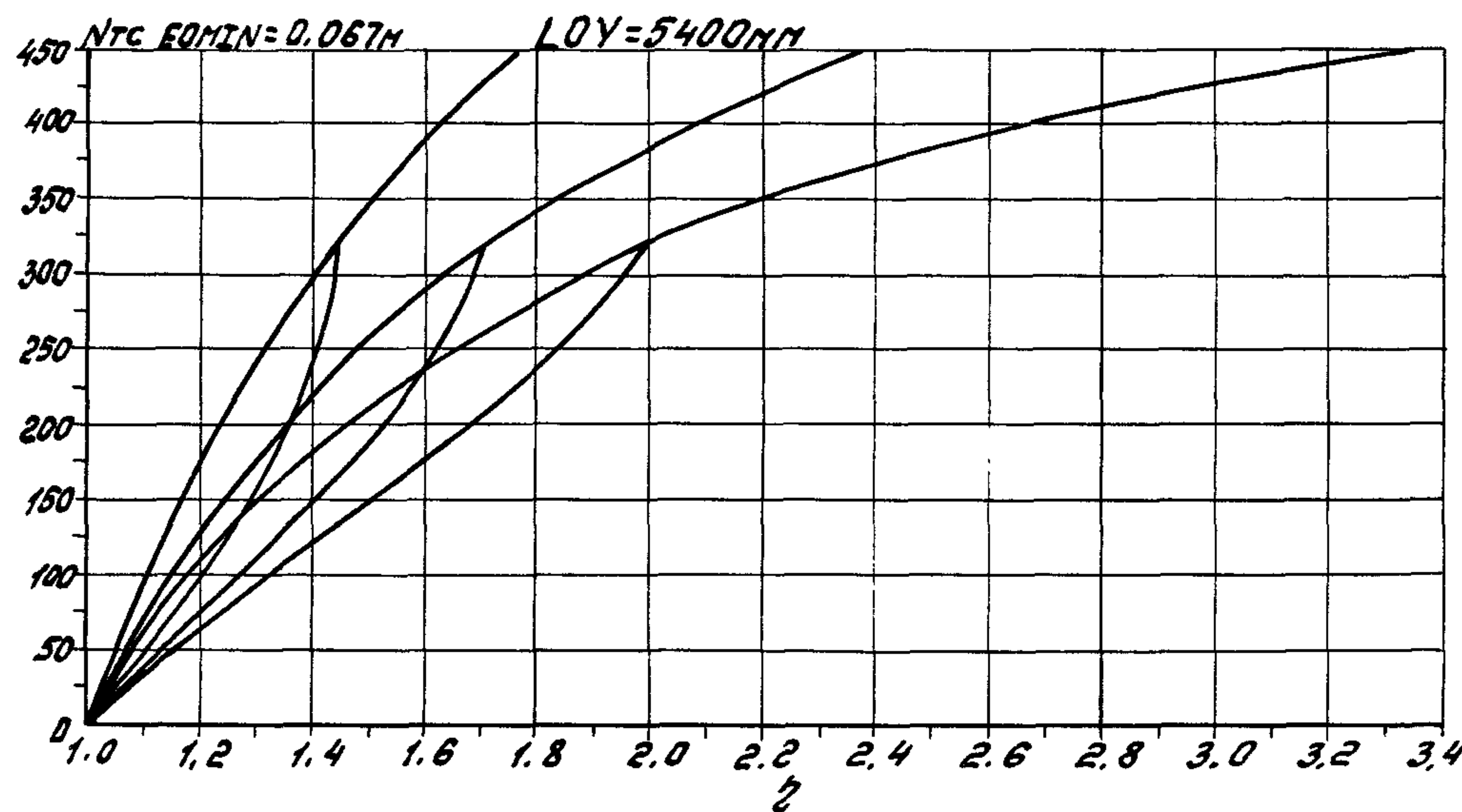
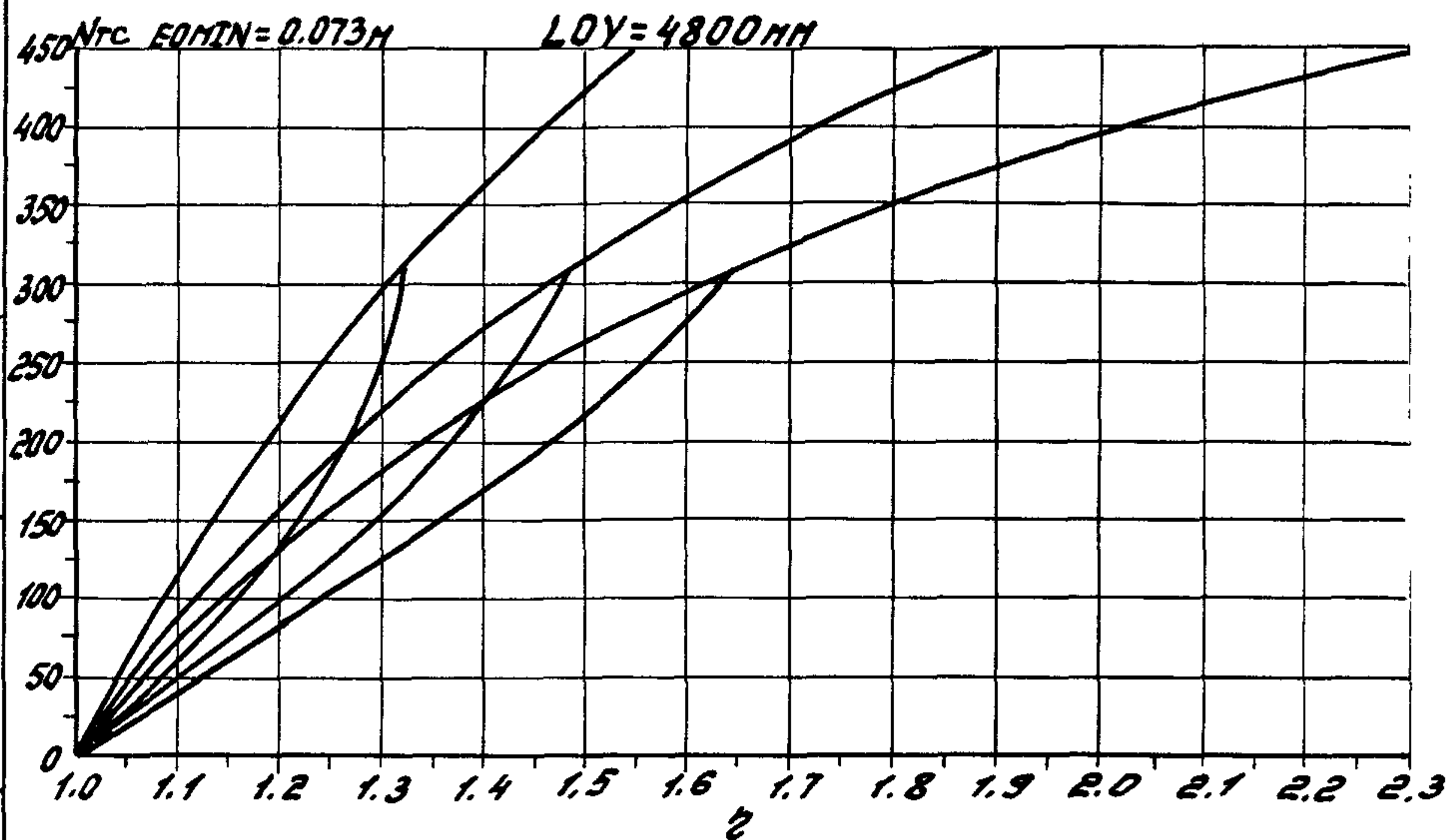
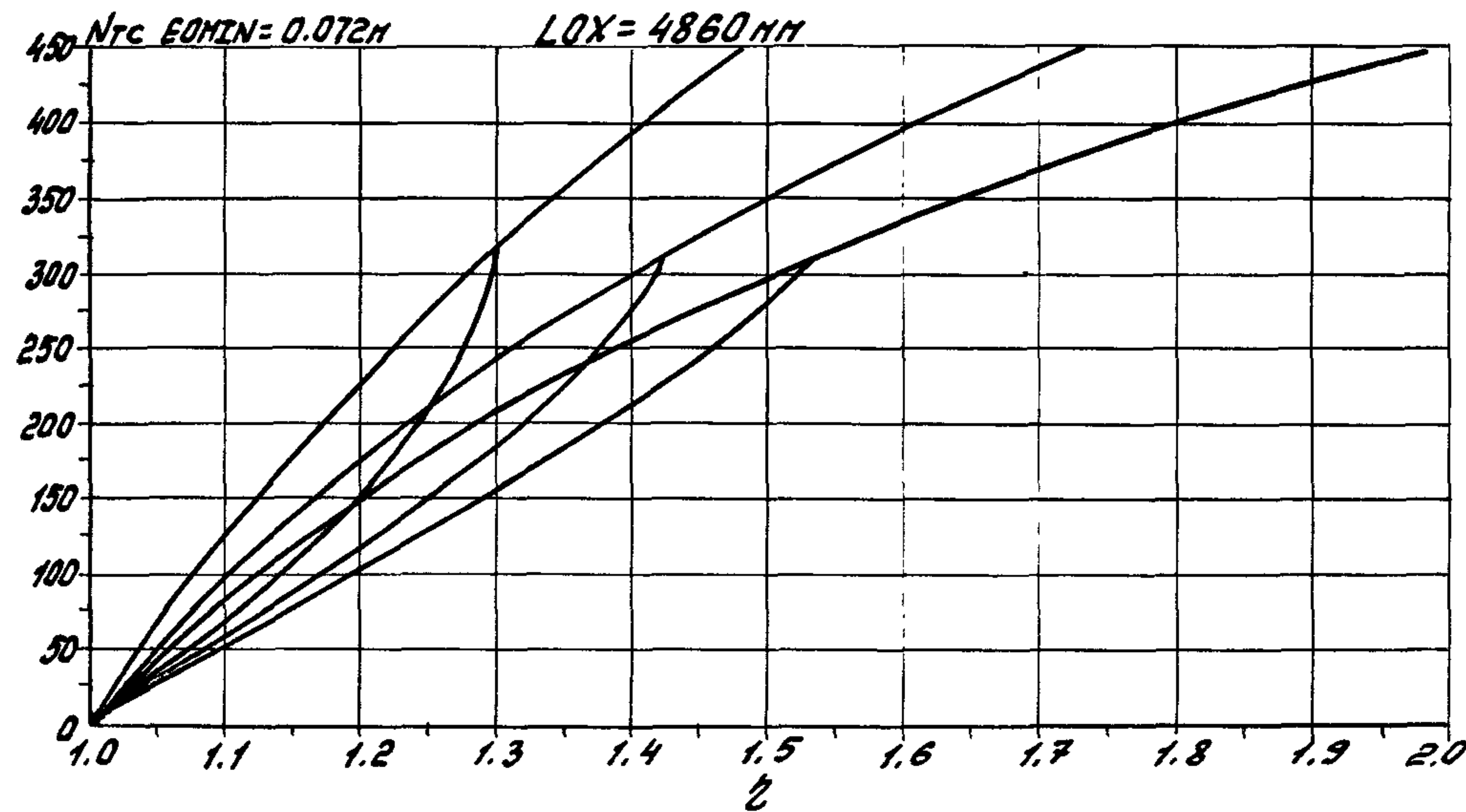
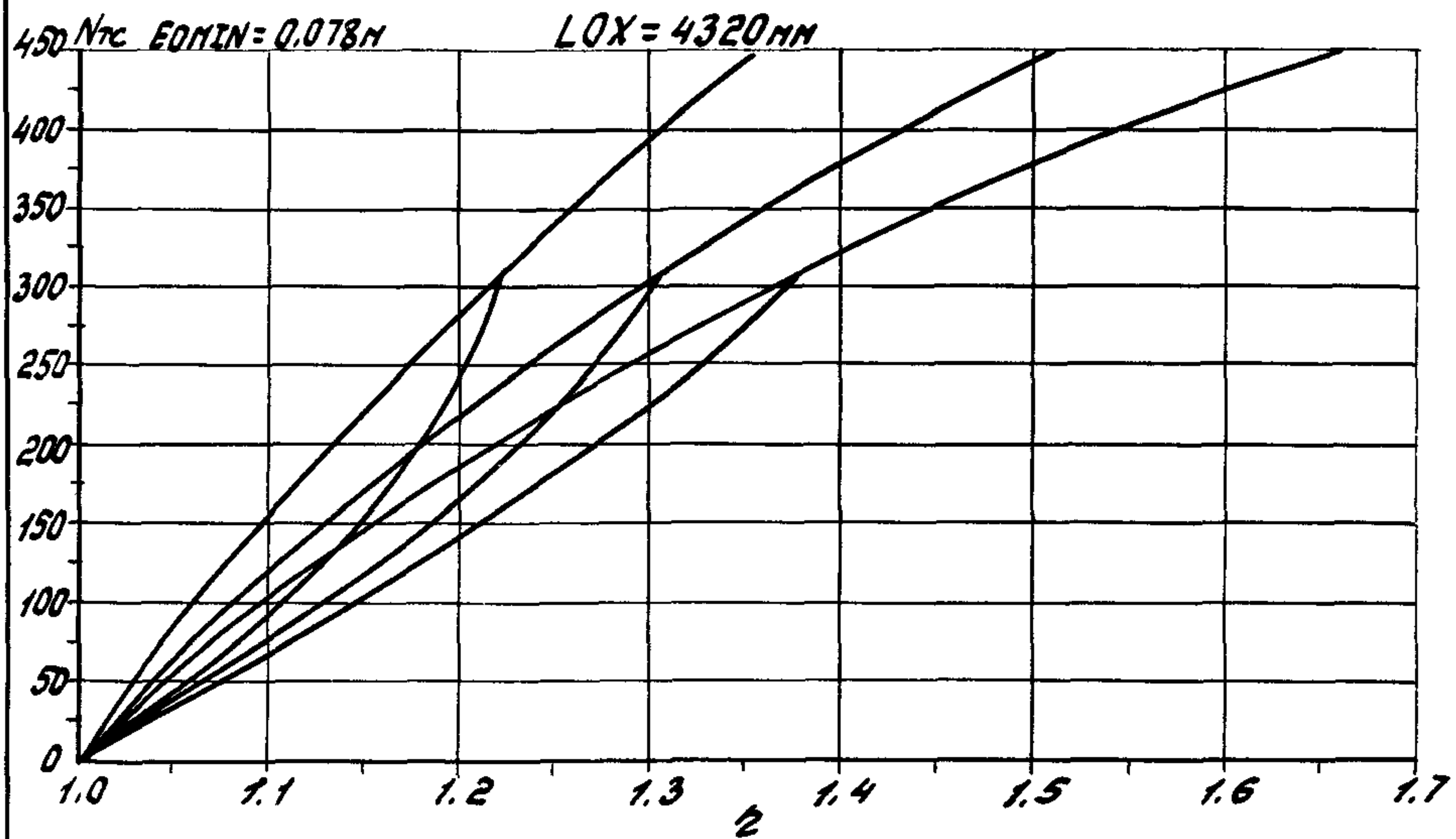

Уч. № 0001. 7120.0000 0301. УР 15 М

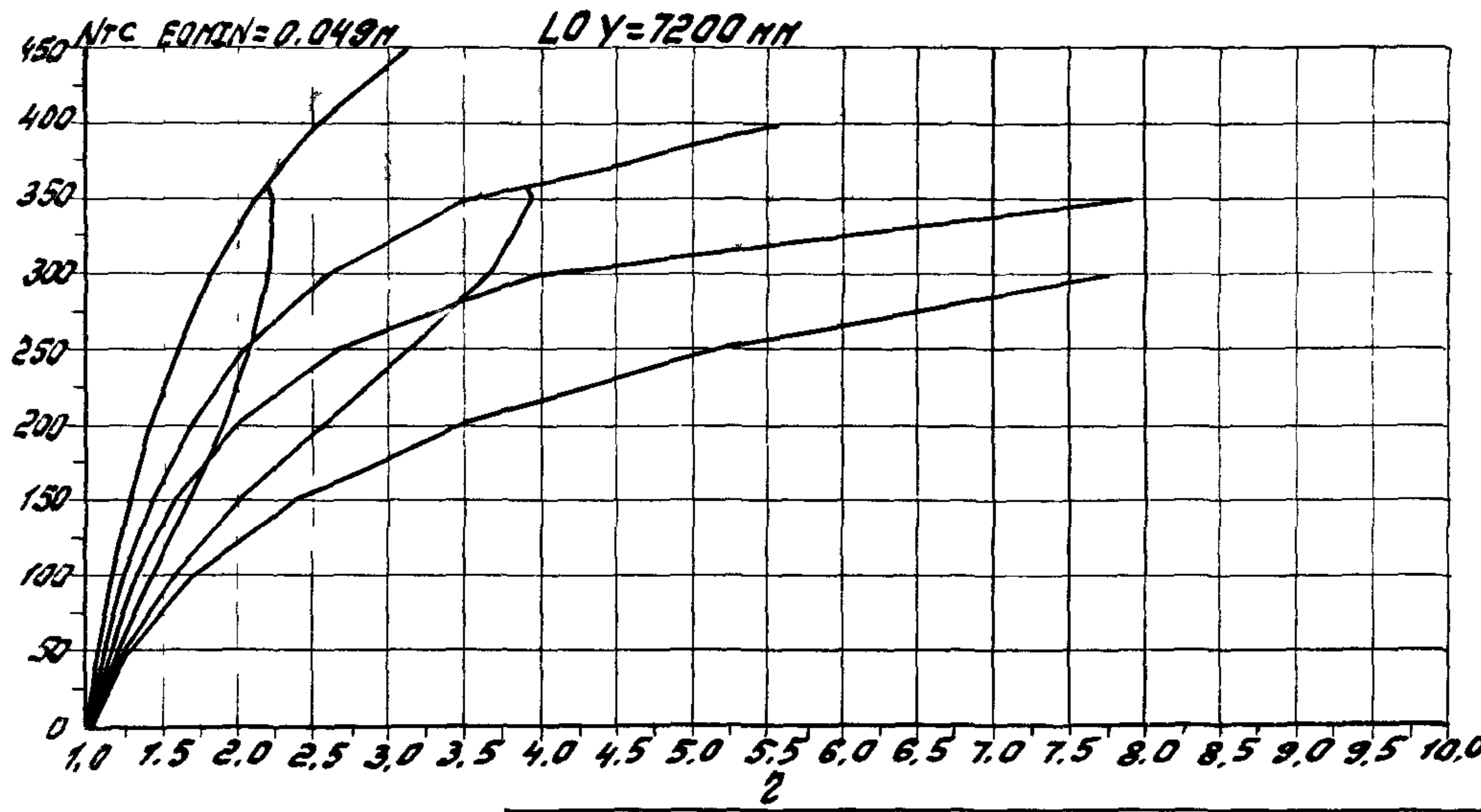
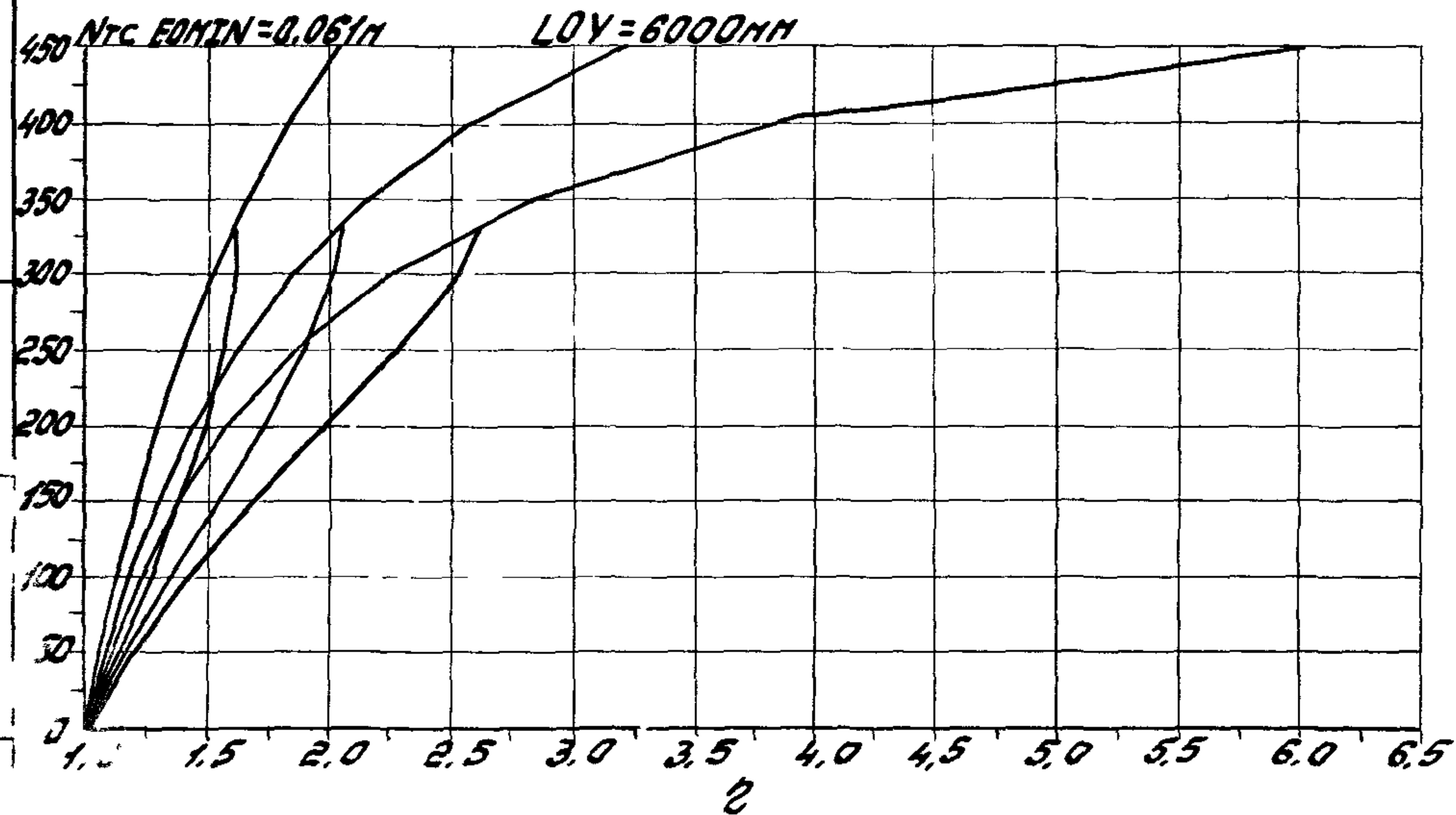
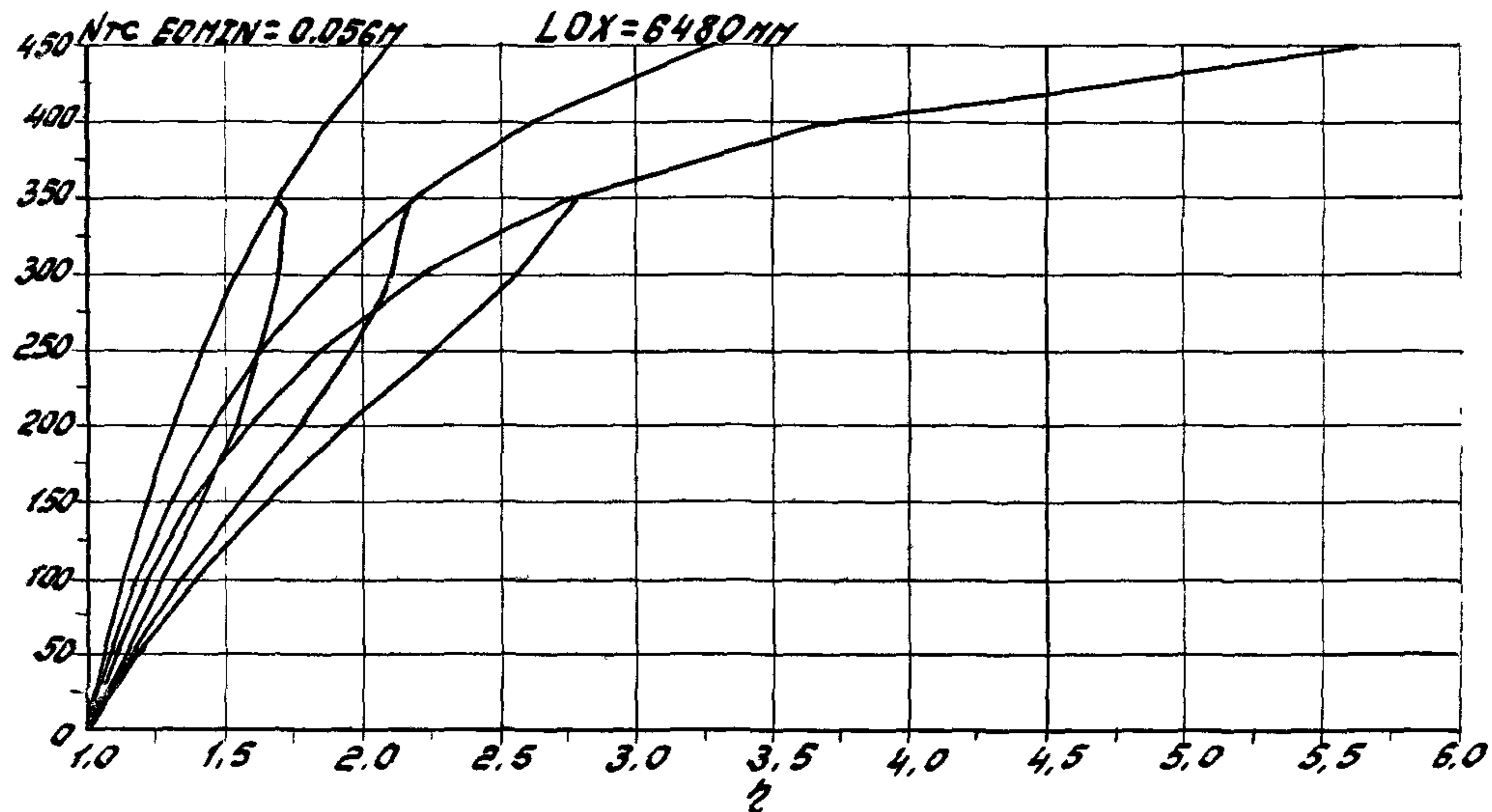
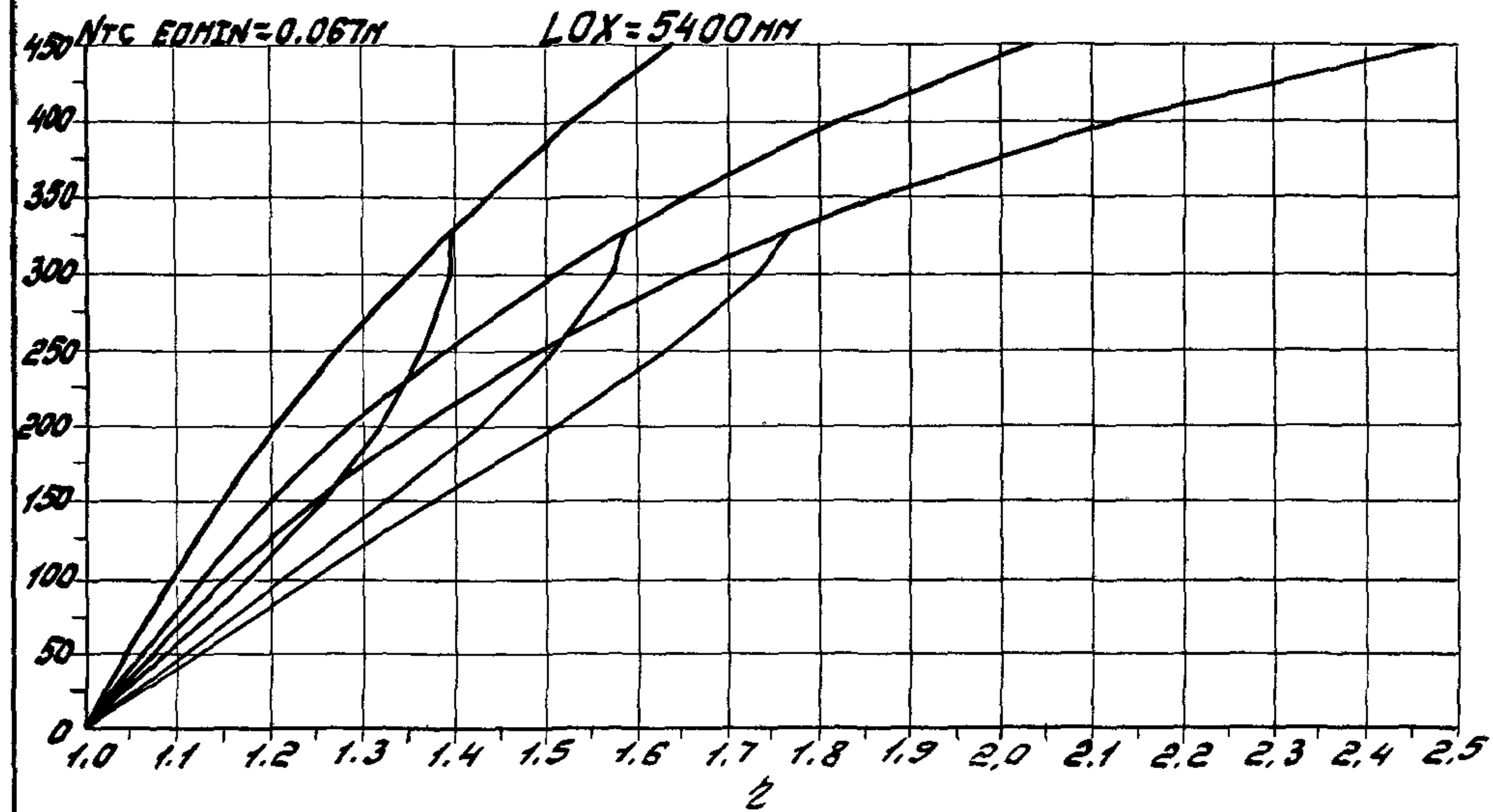

УИВ NTC Подпись и дата В.З.И.И.И.

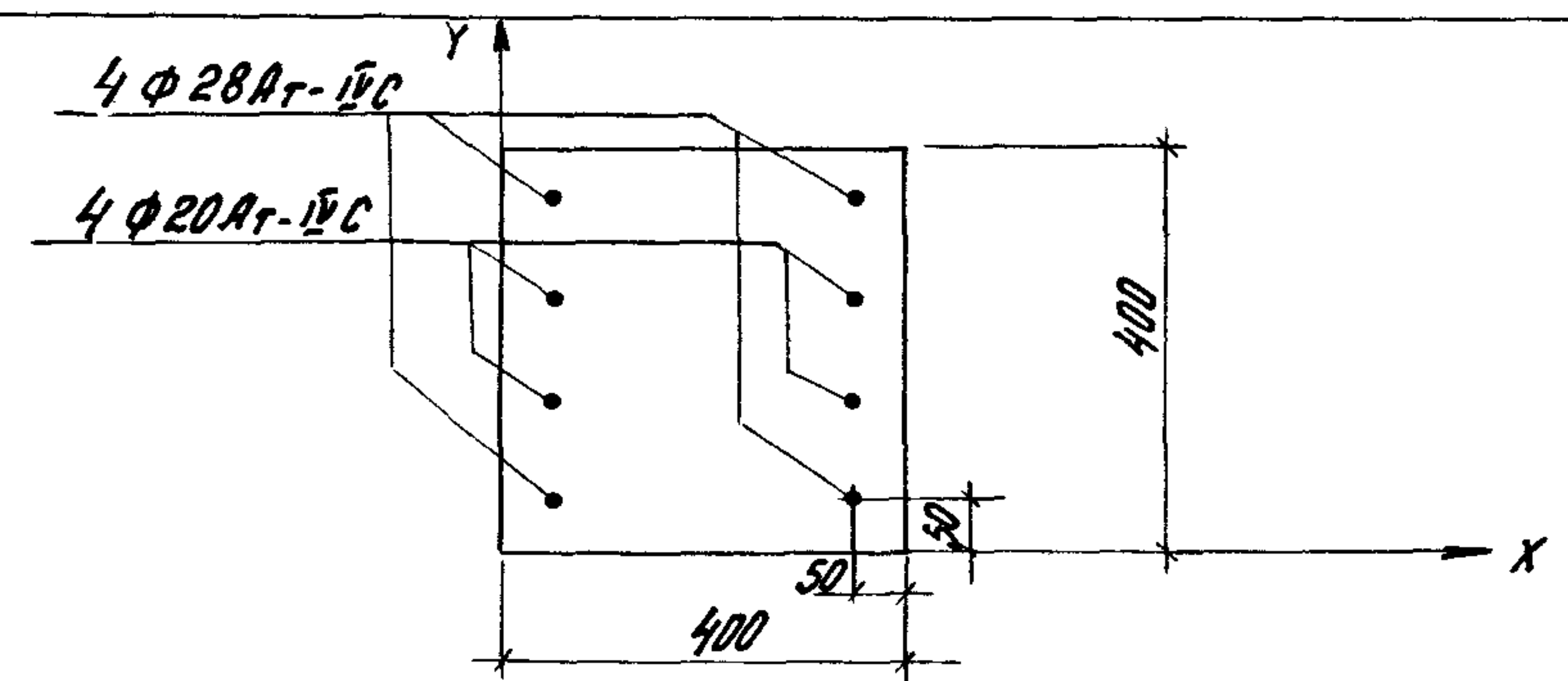
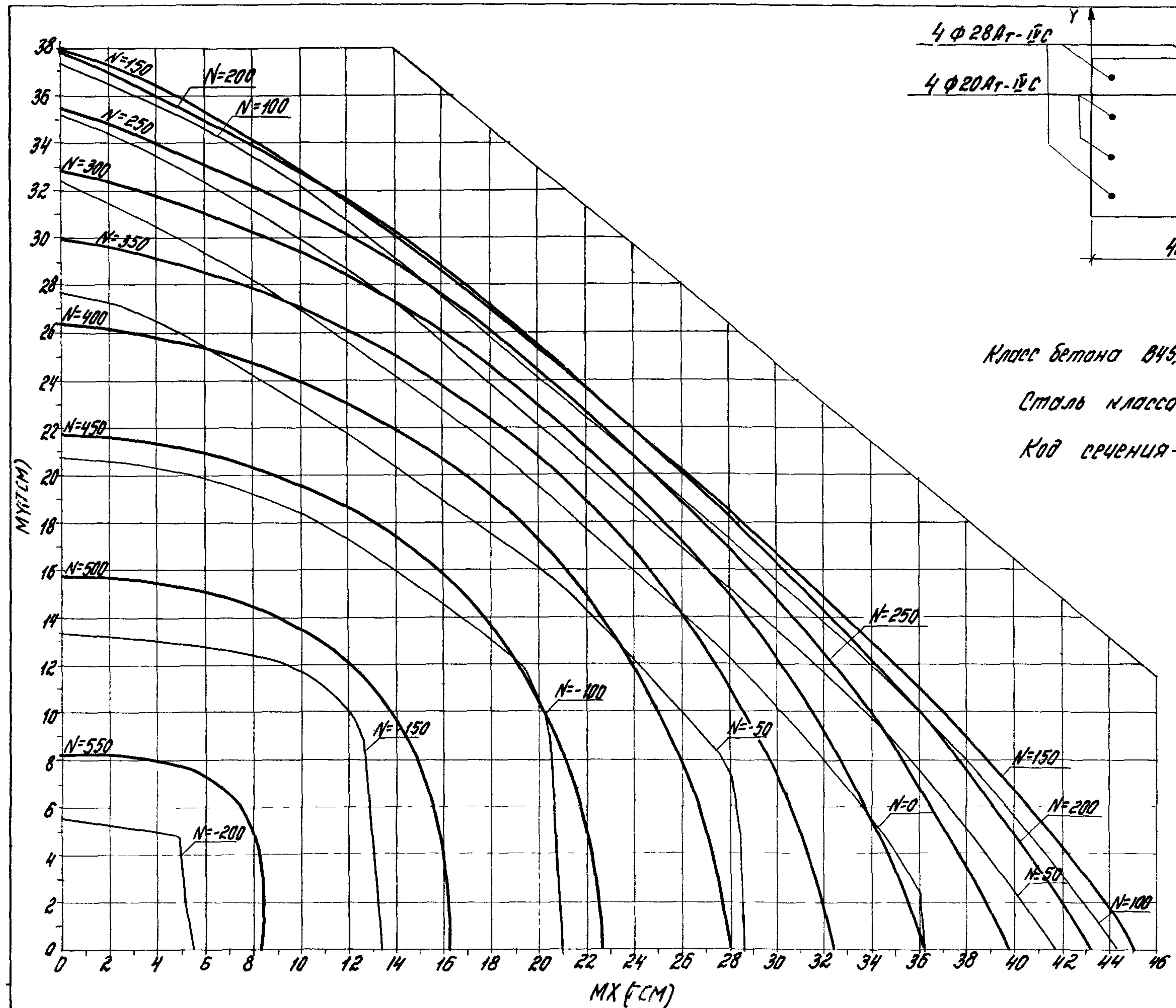

Класс бетона В45,0 ($R_b = 27,5$ МПа при учете $\gamma_{R2} = 1,10$)
 Сталь класса Аγ-IVC
 Код сечения-128а

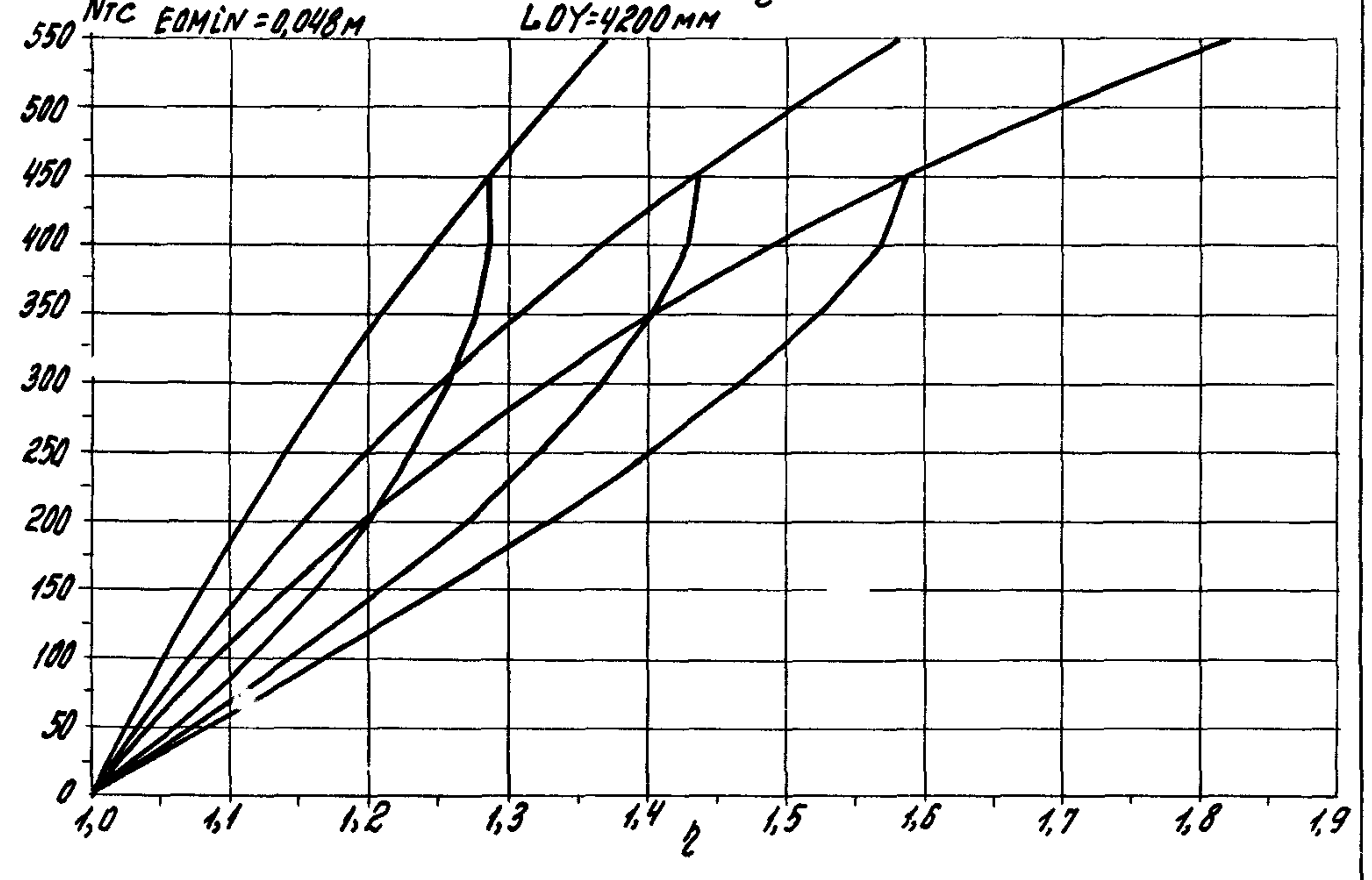
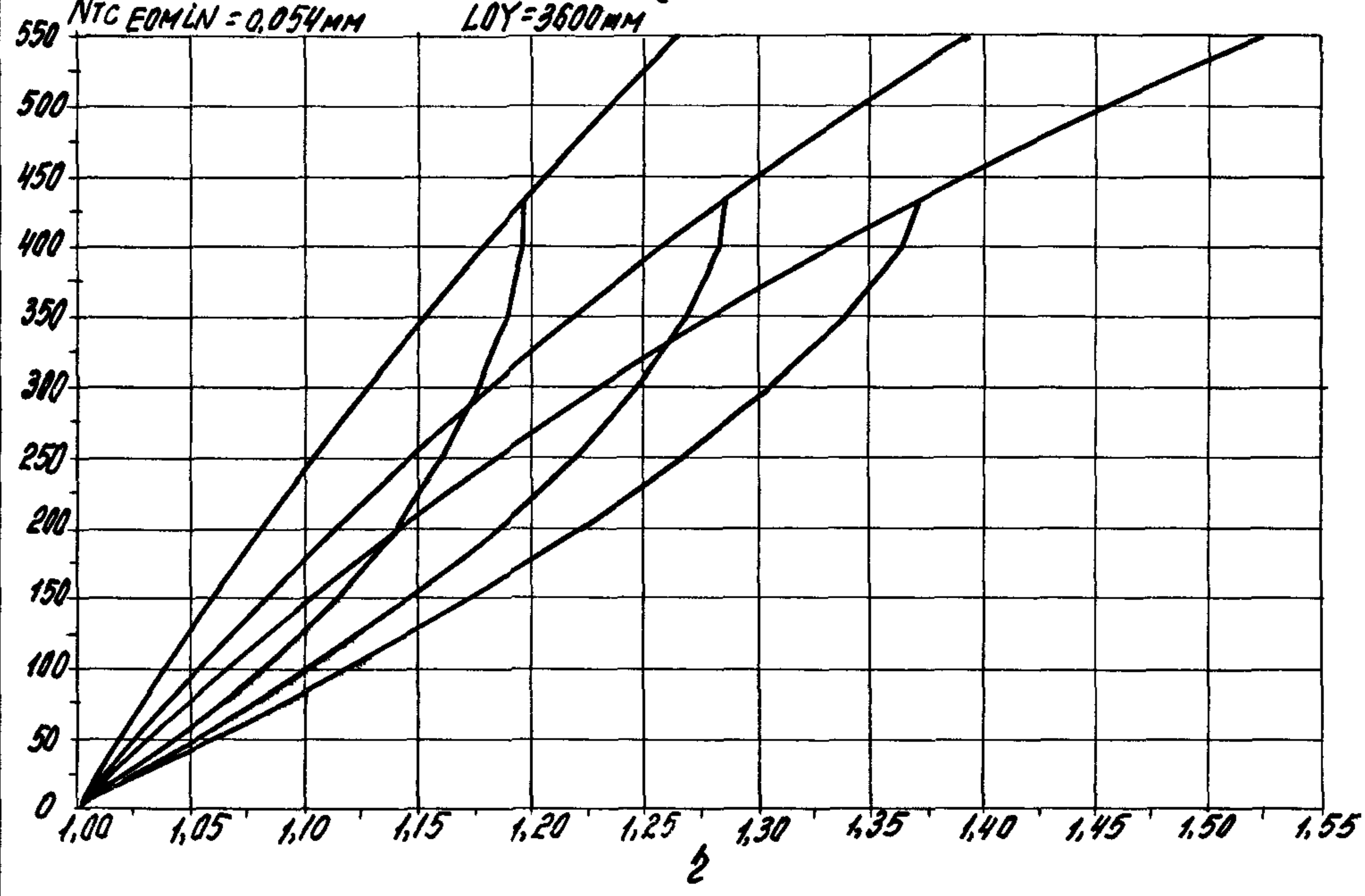
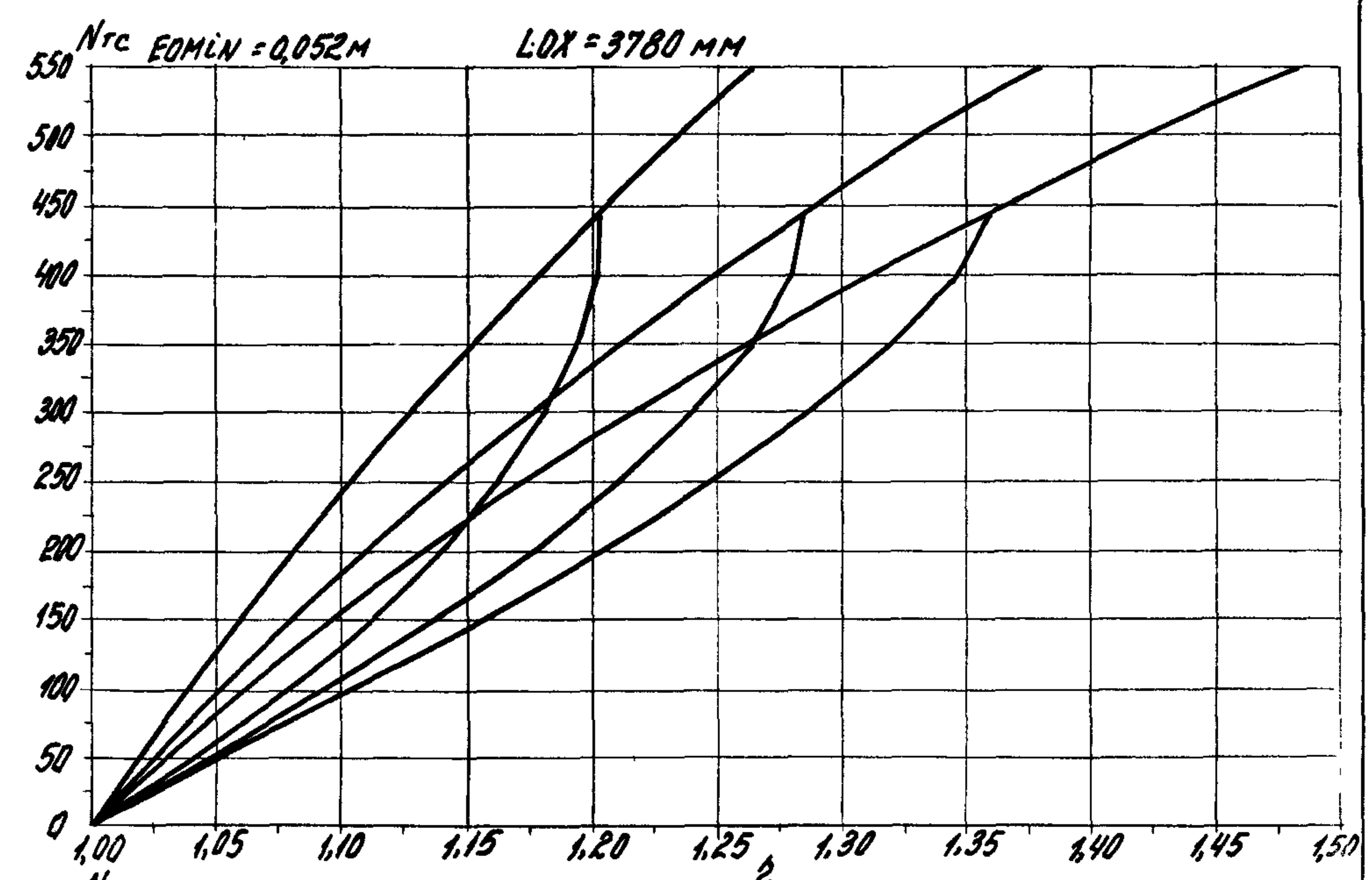
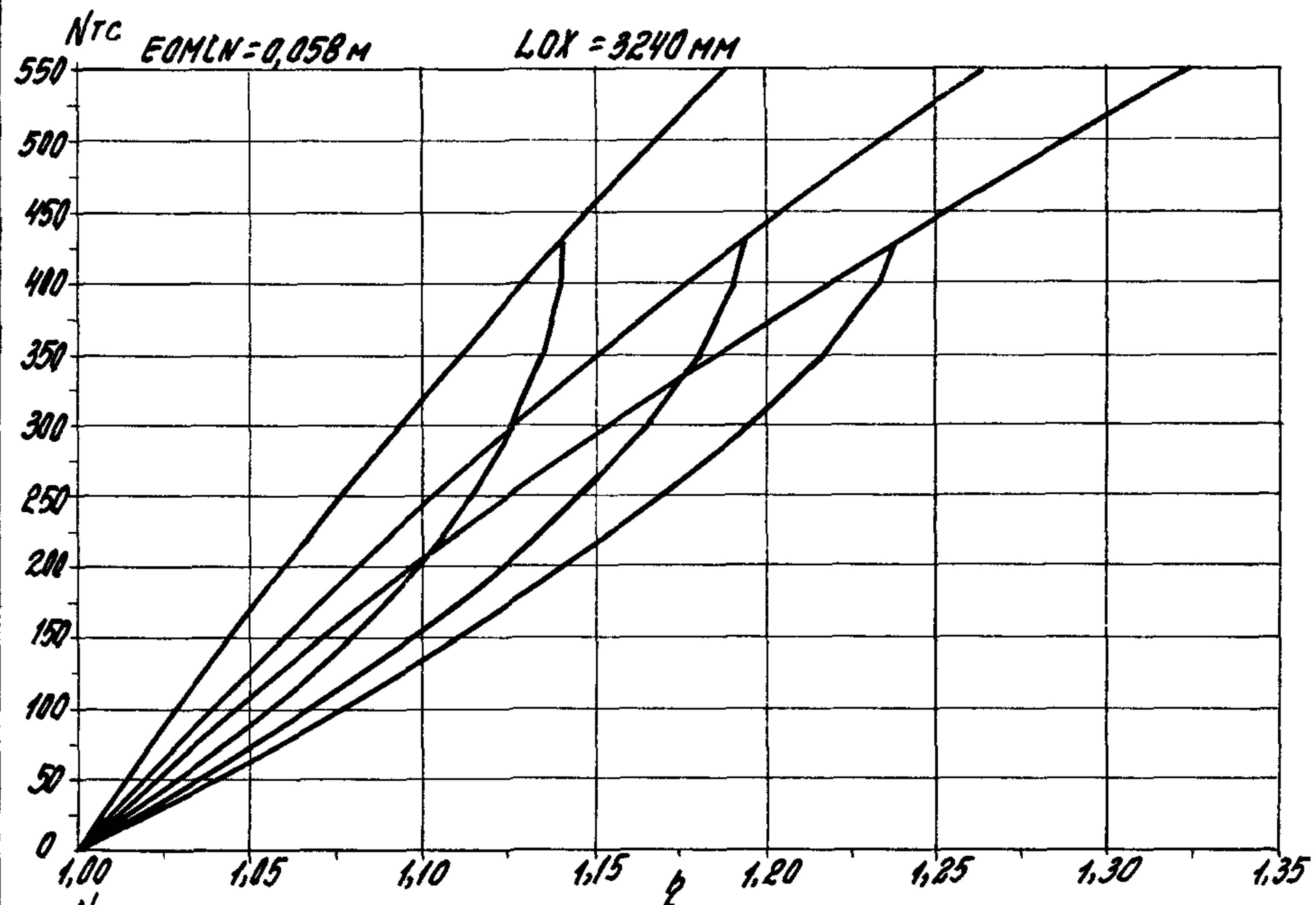

Лин. ММ1000. Угол наклона 630М. Угол 20

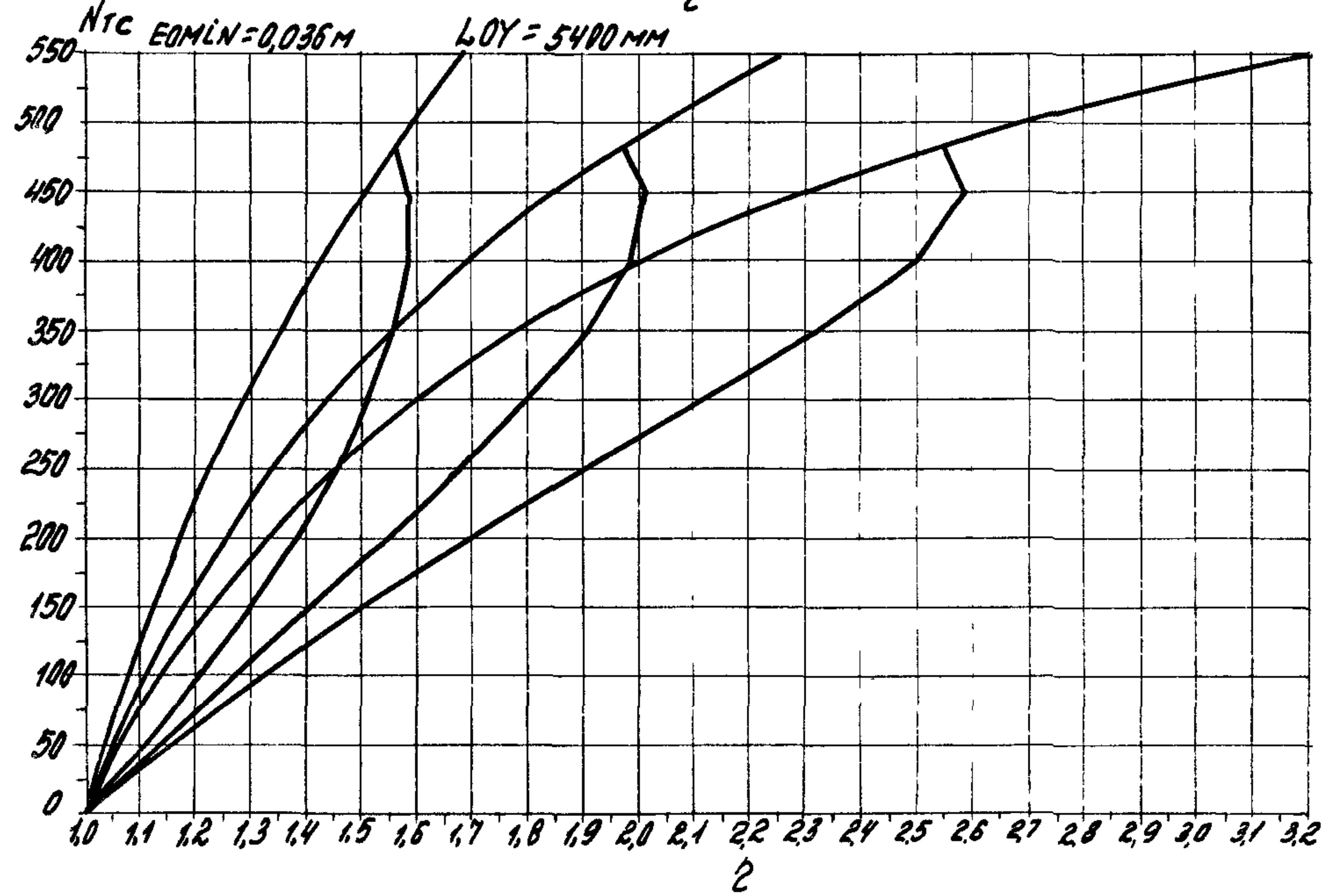
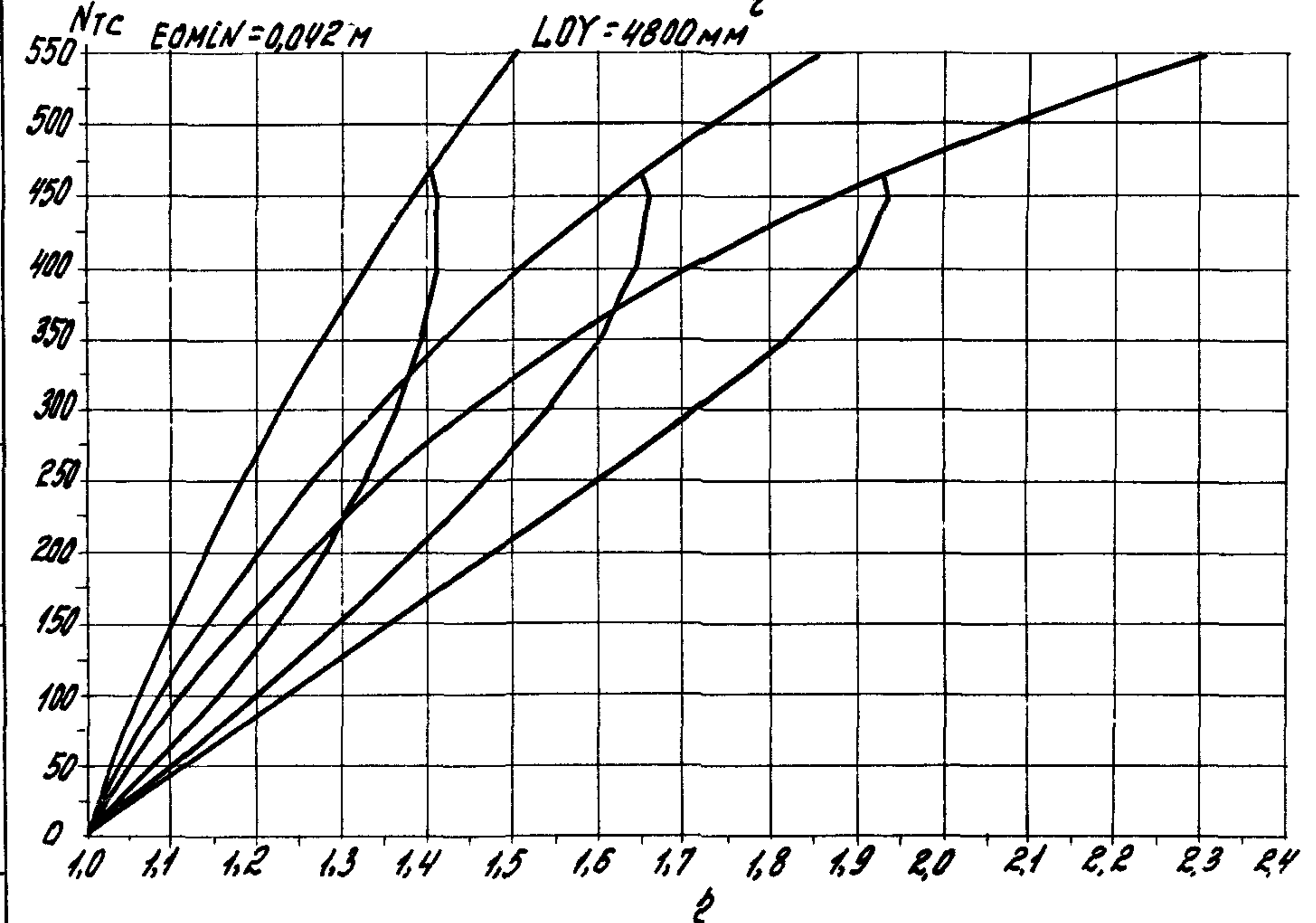
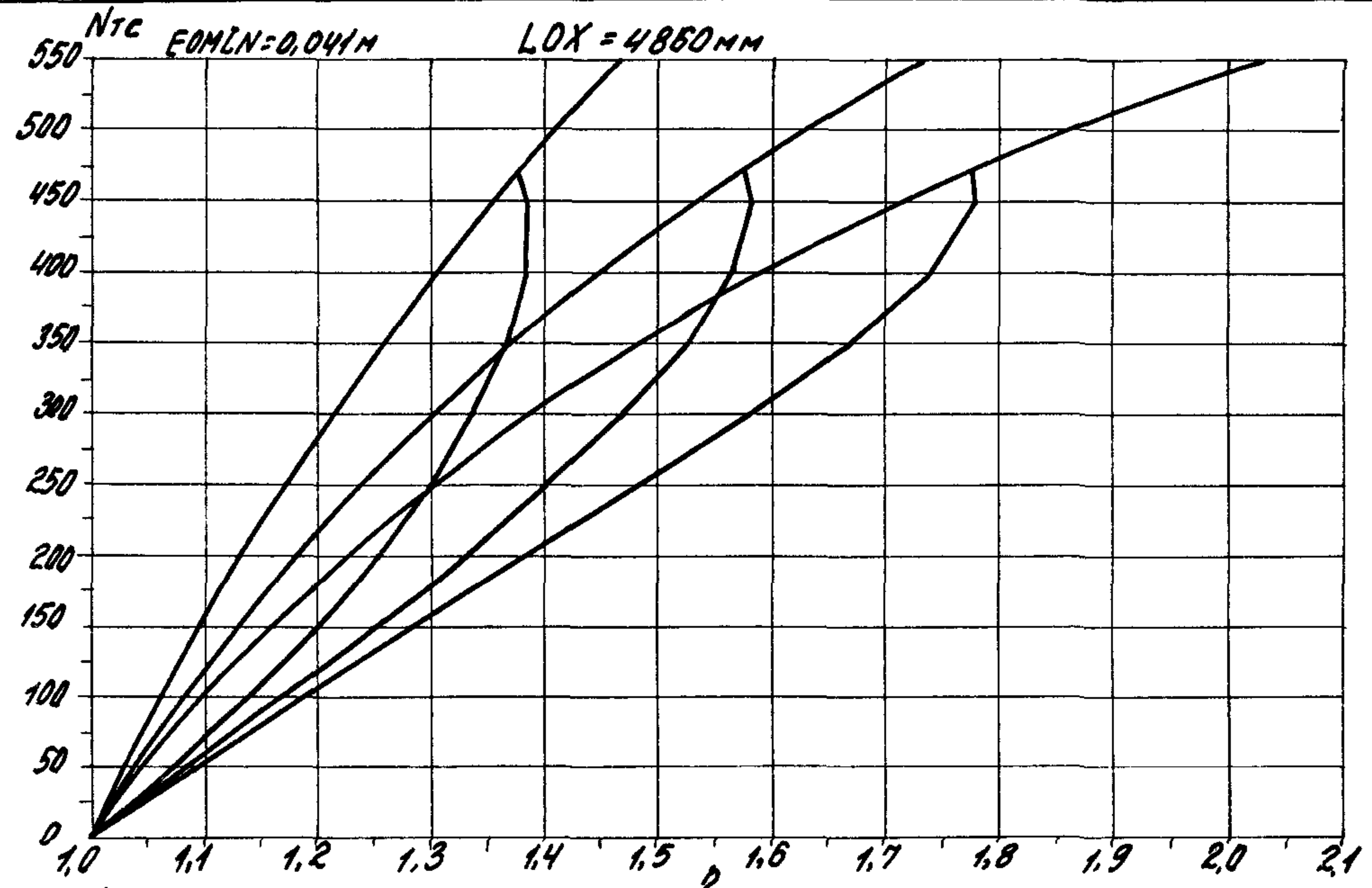
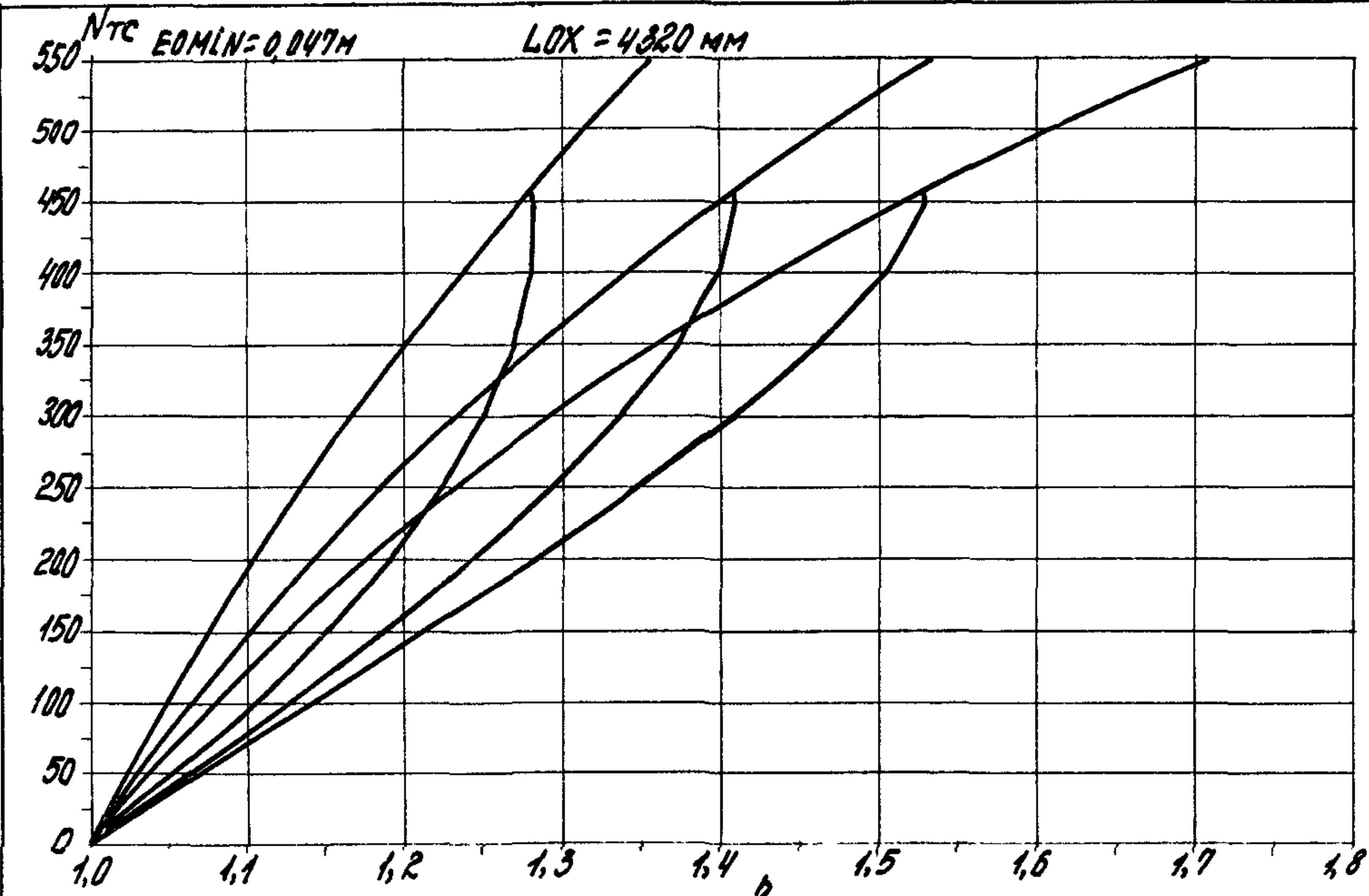

DHD No 1000.1 / 1100 26 6 116 118 120 122 124 126 128 130 132 134 136 138 140 142 144 146 148 150 152 154 156 158 160 162 164 166 168 170 172 174 176 178 180 182 184 186 188 190 192 194 196 198 200 202 204 206 208 210 212 214 216 218 220 222 224 226 228 230 232 234 236 238 240 242 244 246 248 250 252 254 256 258 260 262 264 266 268 270 272 274 276 278 280 282 284 286 288 290 292 294 296 298 300 302 304 306 308 310 312 314 316 318 320 322 324 326 328 330 332 334 336 338 340 342 344 346 348 350 352 354 356 358 360 362 364 366 368 370 372 374 376 378 380 382 384 386 388 390 392 394 396 398 400 402 404 406 408 410 412 414 416 418 420 422 424 426 428 430 432 434 436 438 440 442 444 446 448 450 452 454 456 458 460 462 464 466 468 470 472 474 476 478 480 482 484 486 488 490 492 494 496 498 500

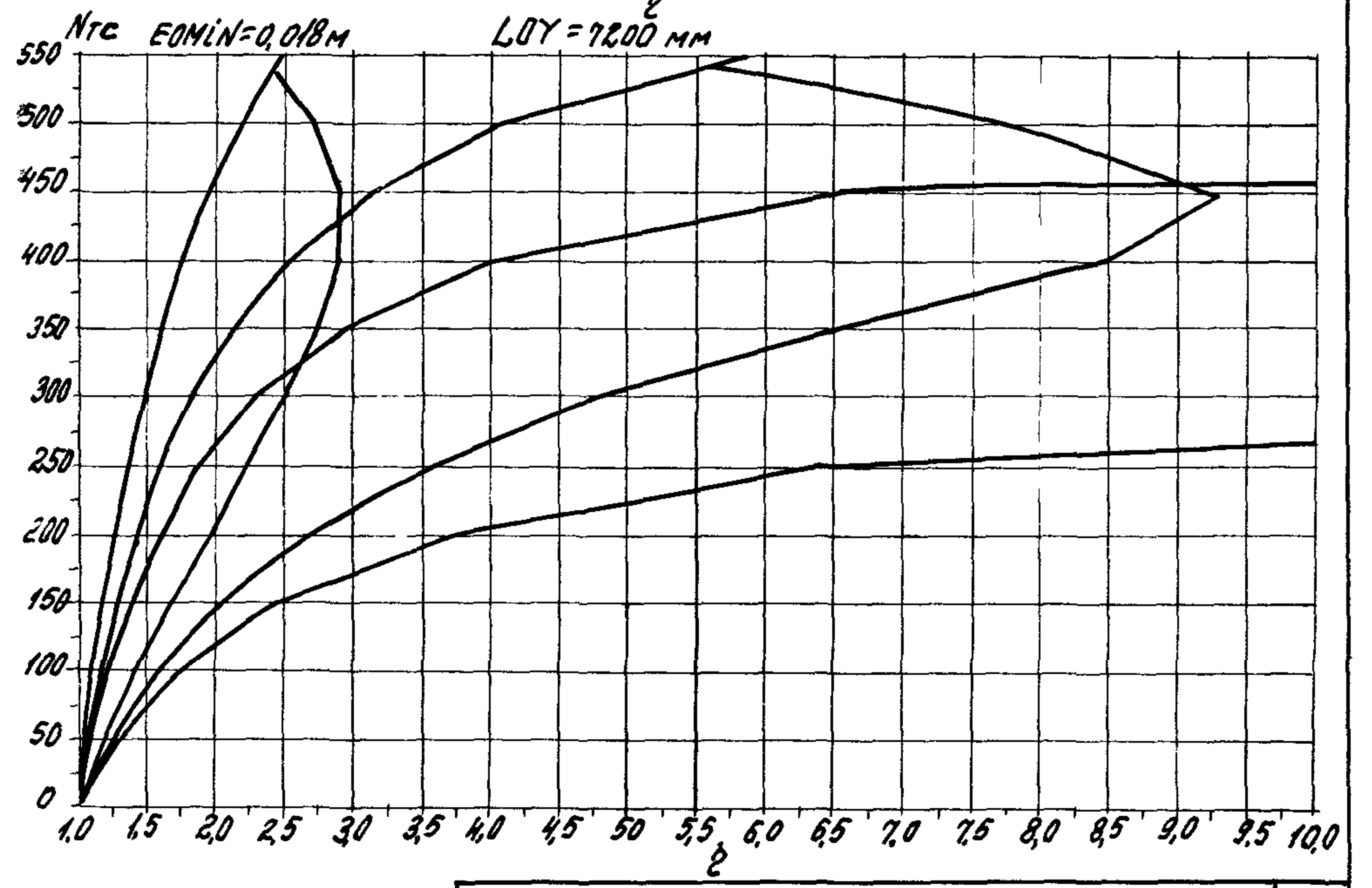
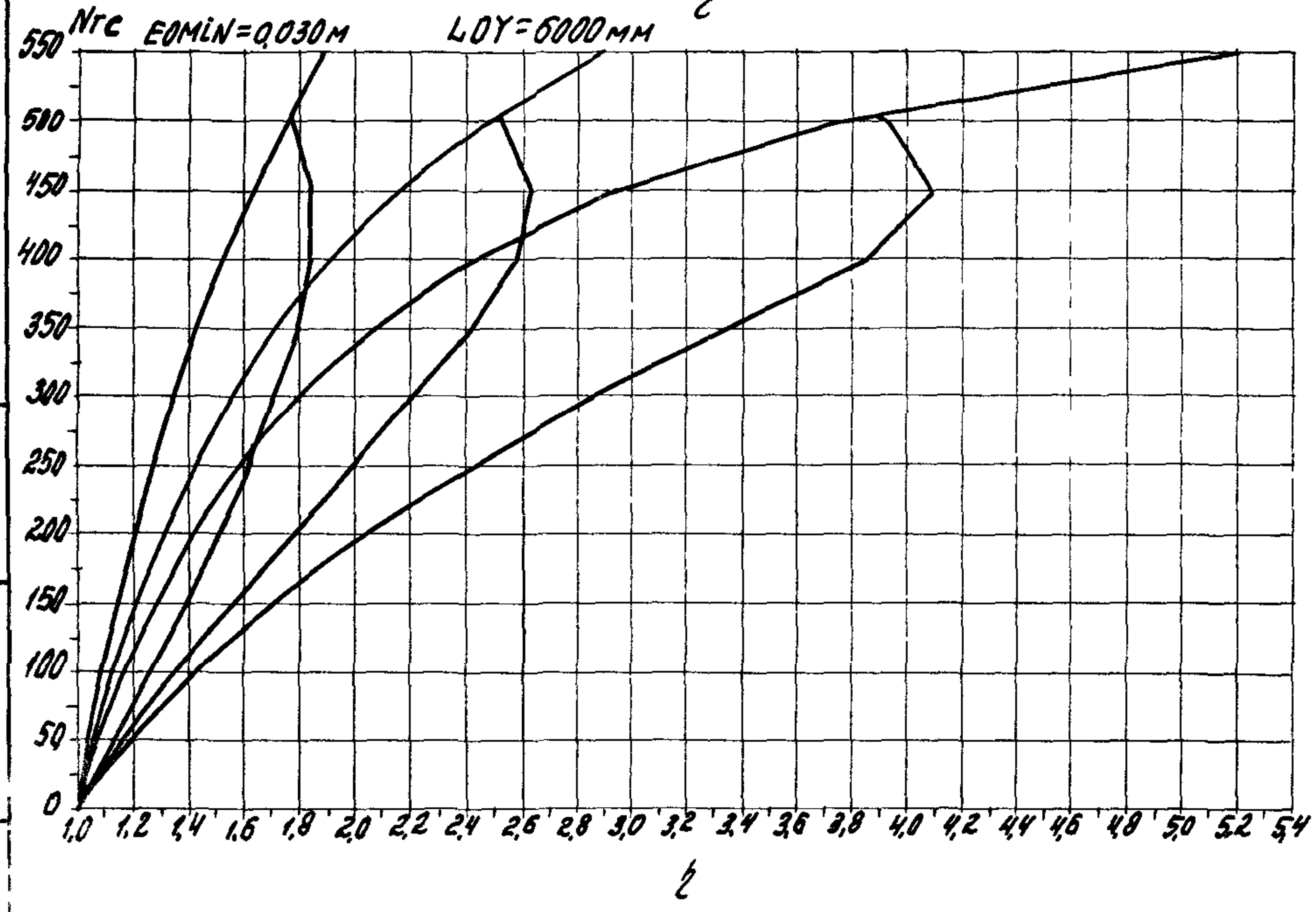
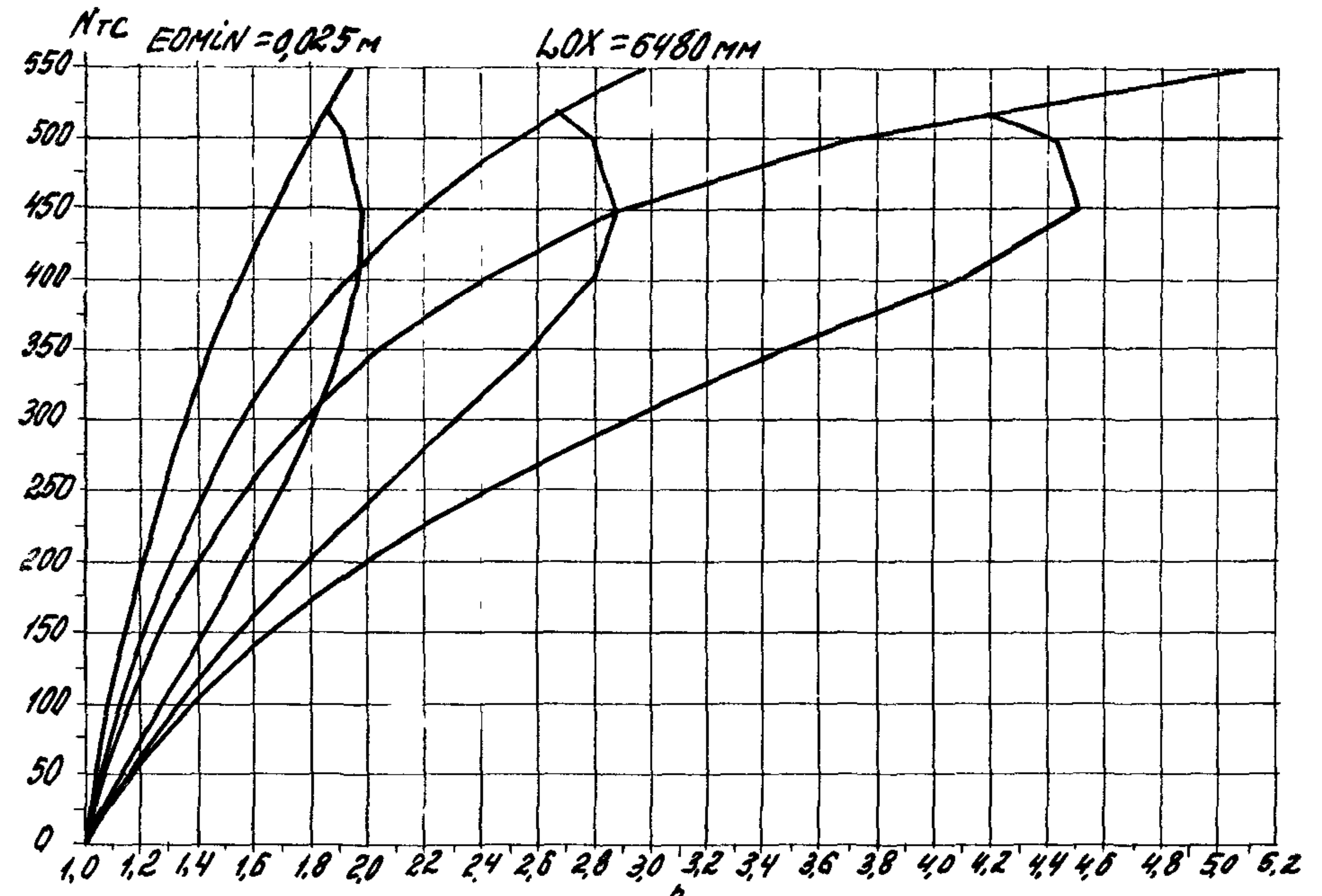
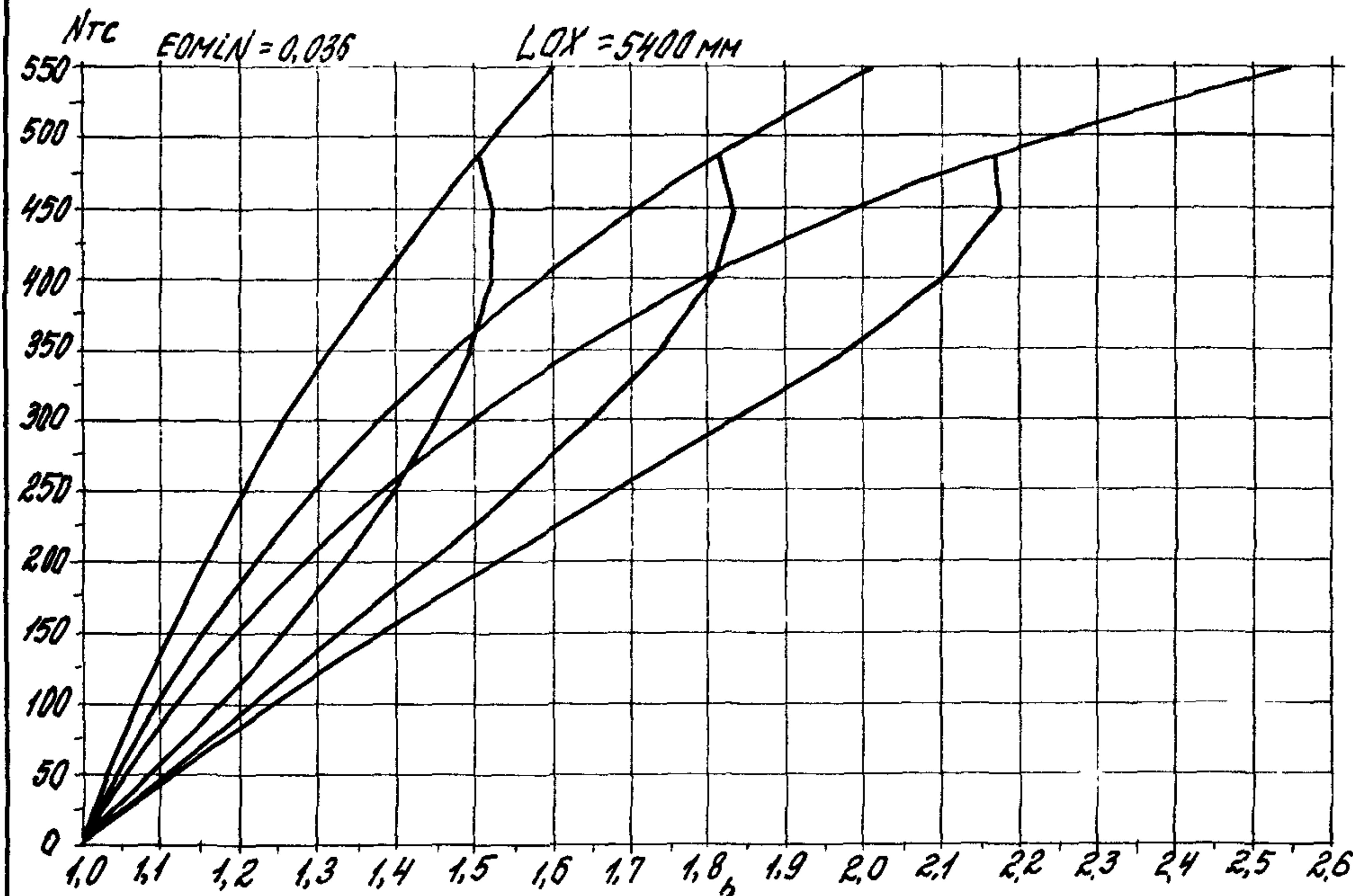

МАШИНА ПРОЕКТА
 ДИЗАЙН И КОНСТРУКЦИЯ
 ЧЕРТЕЖИ

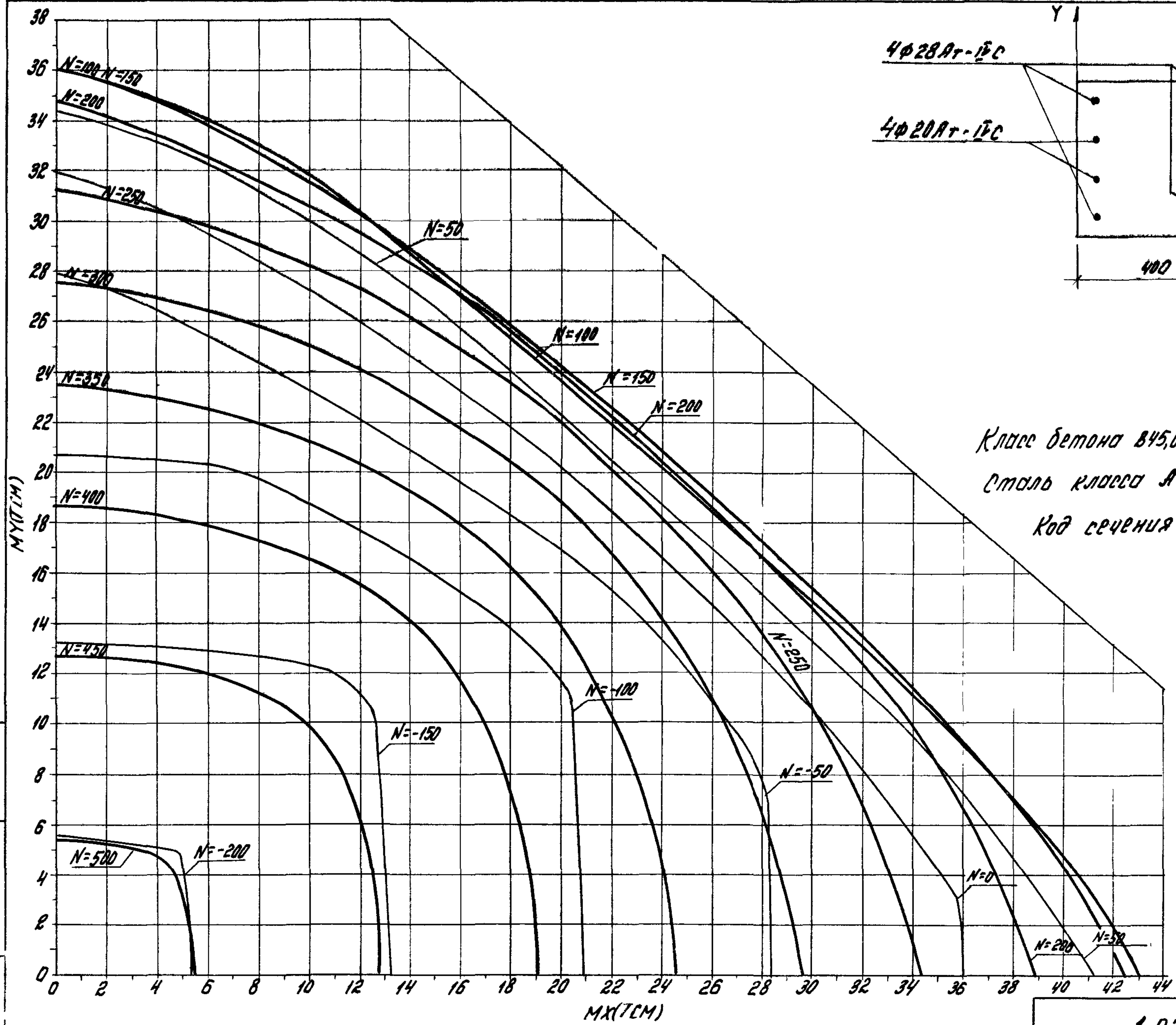

4φ28Aт-IVС

4φ20Aт-IVС

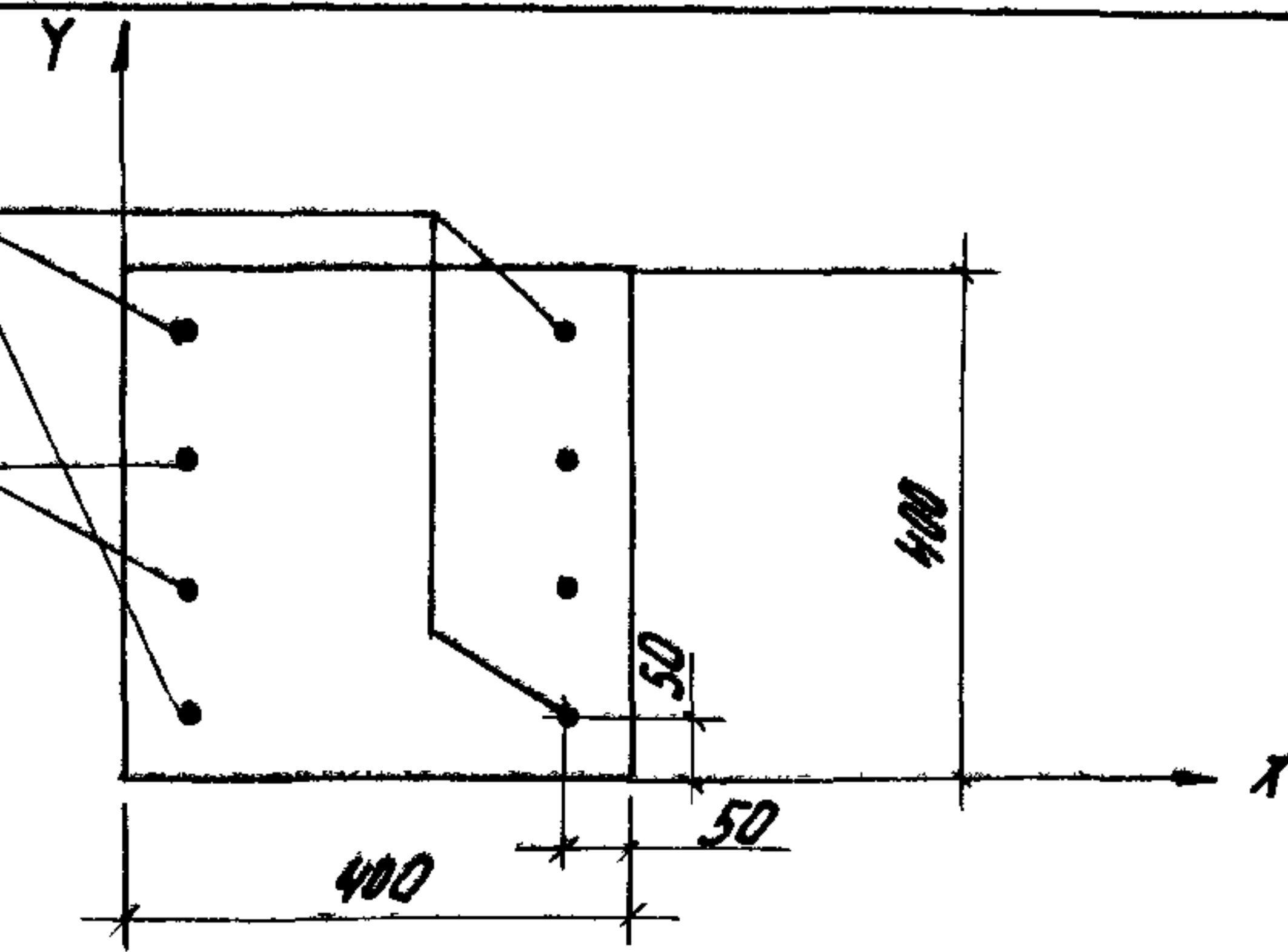

Класс бетона В45,0 ($R_b = 22,5$ МПа при учете $\gamma_{R2} = 0,90$)

Сталь класса Ат-IVС

Код сечения - 128δ

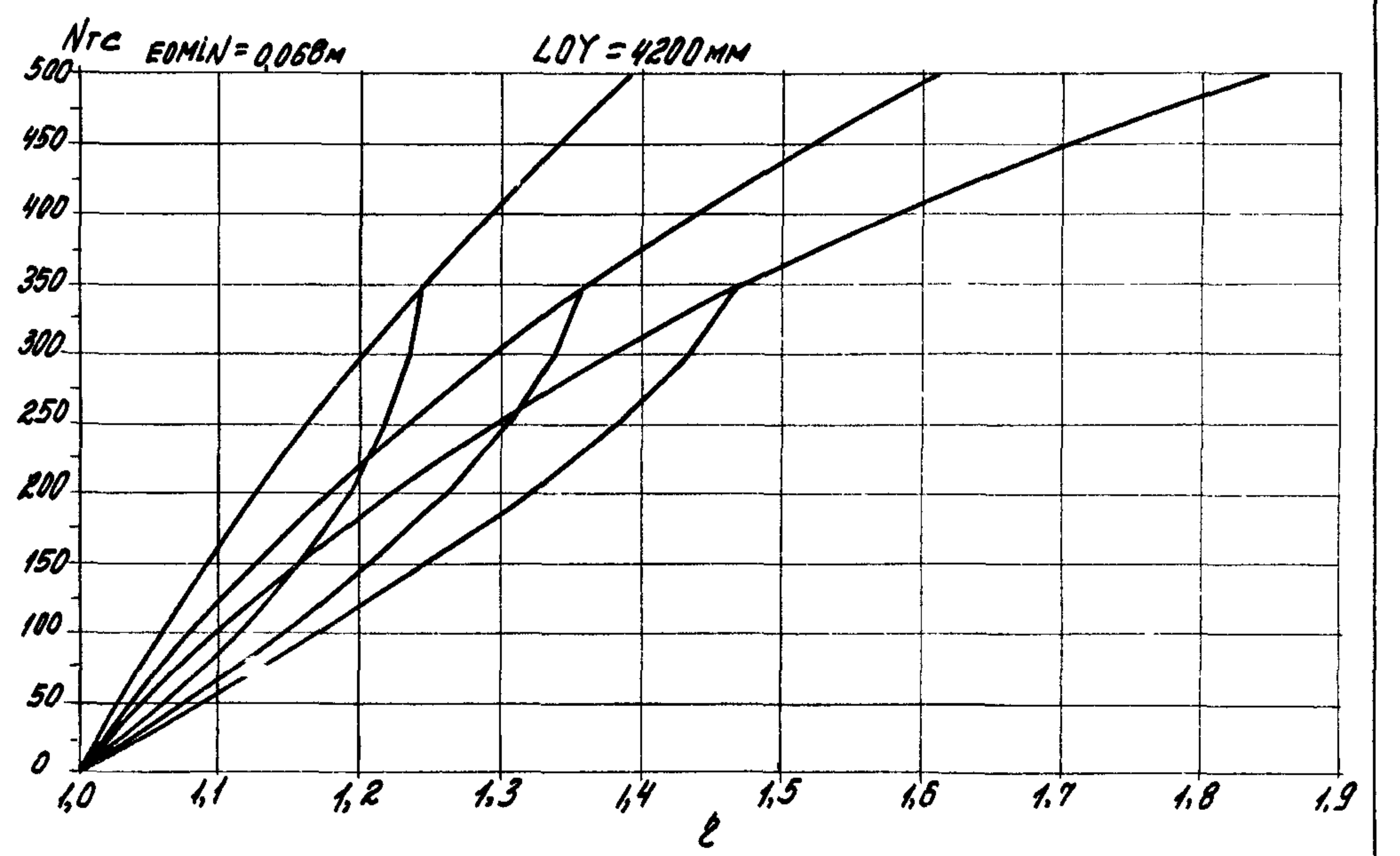
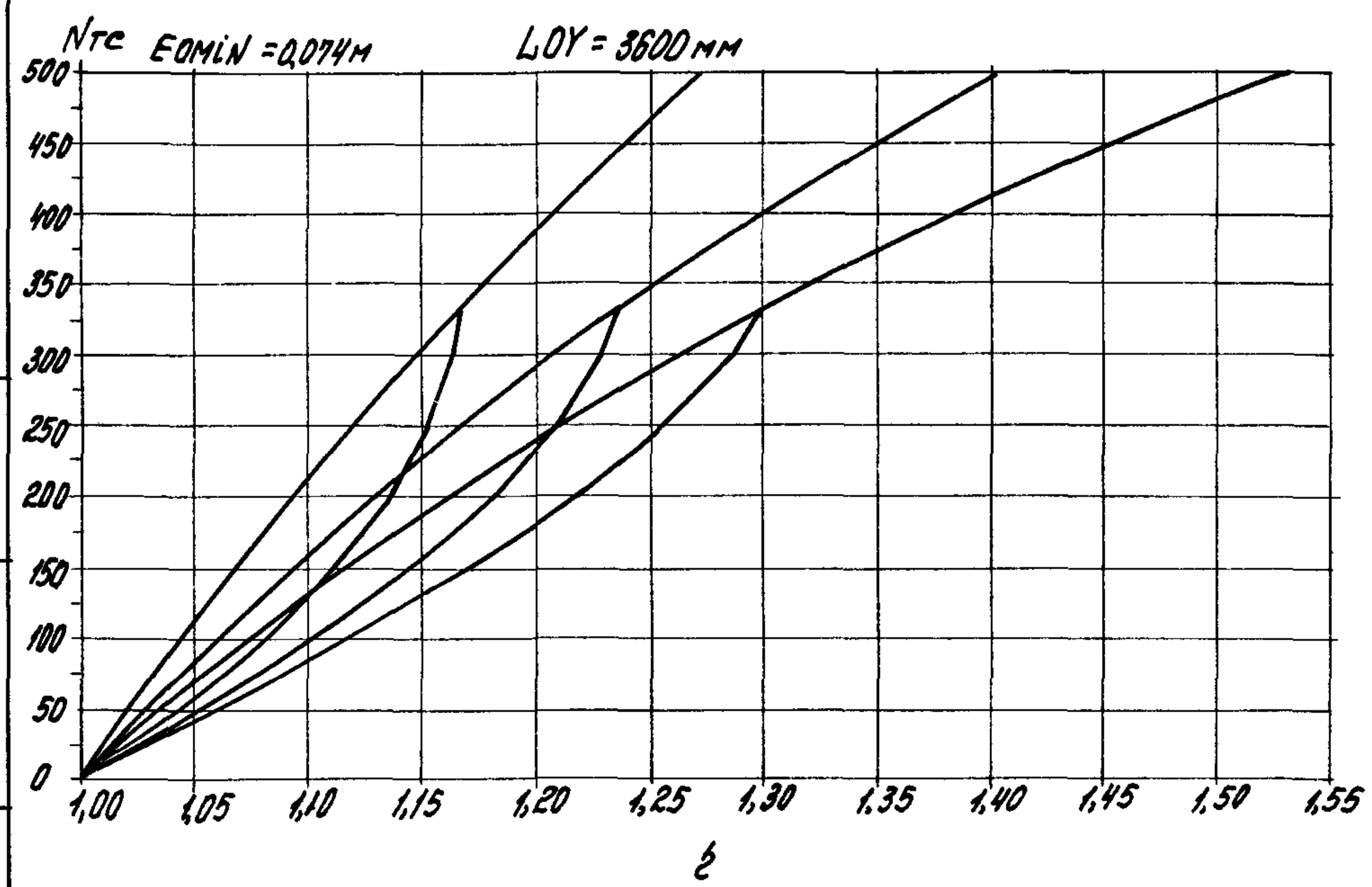
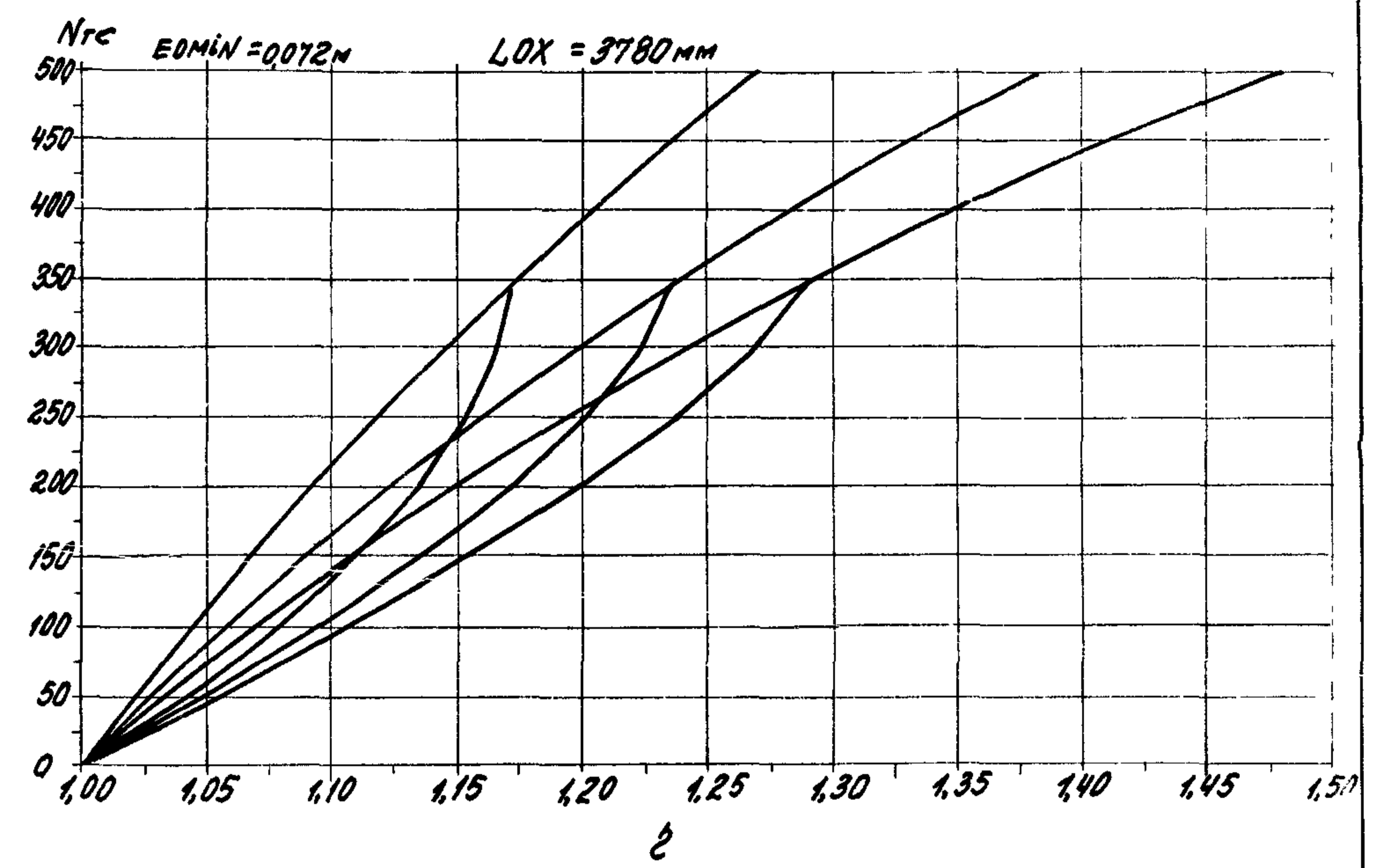
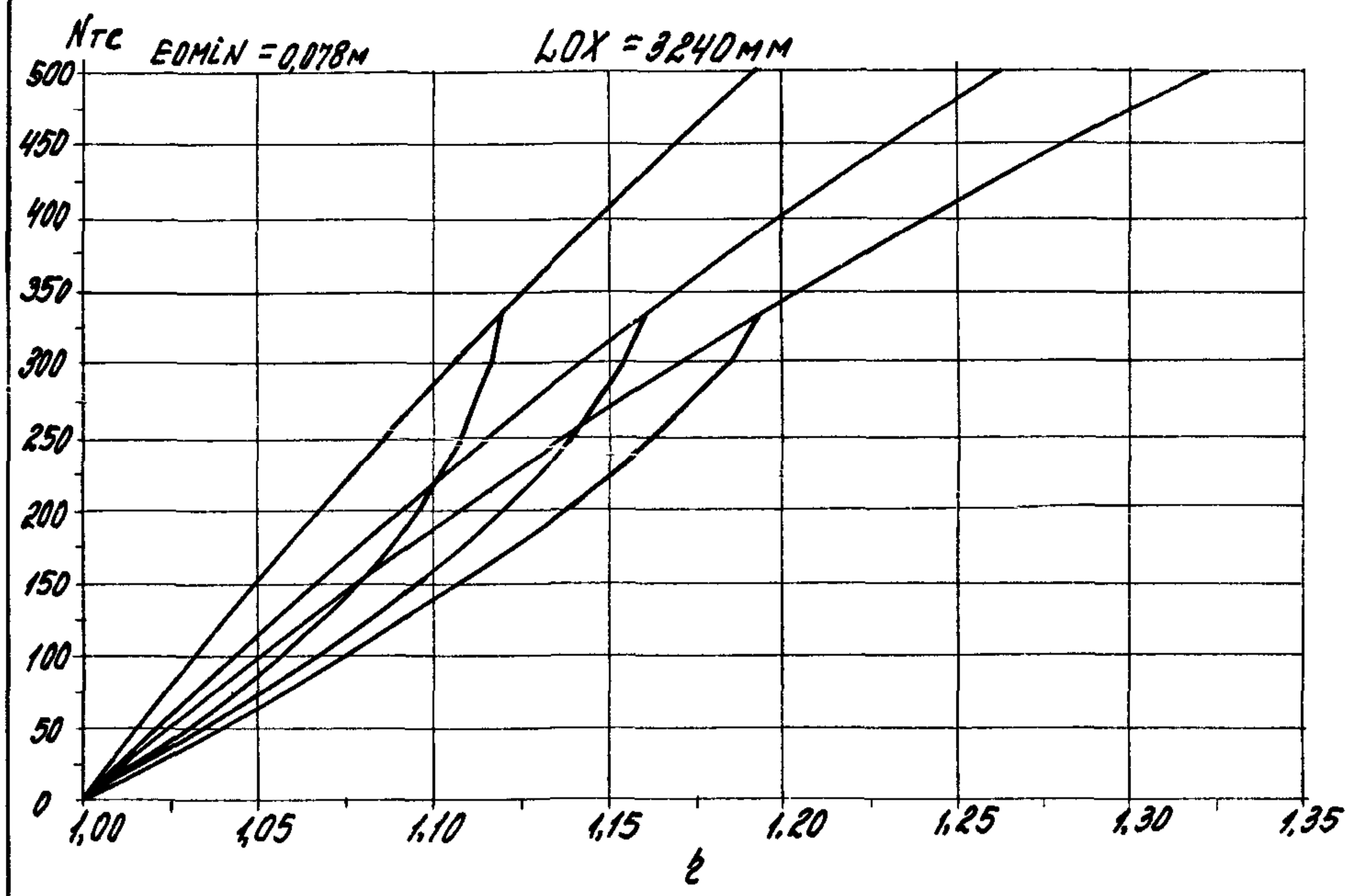

Лит. № 1111111. (Содержит 4 черт. № 1-4)

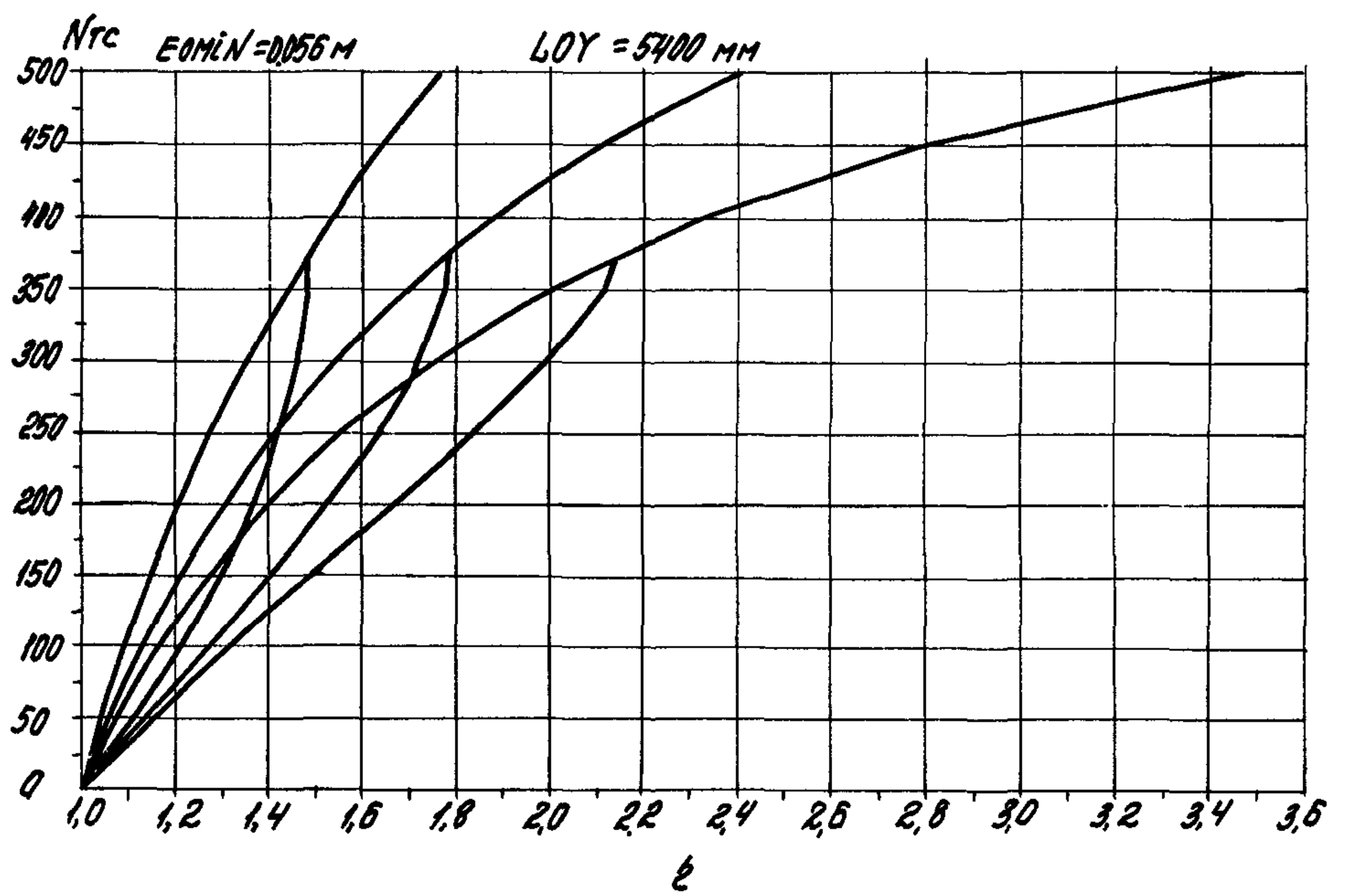
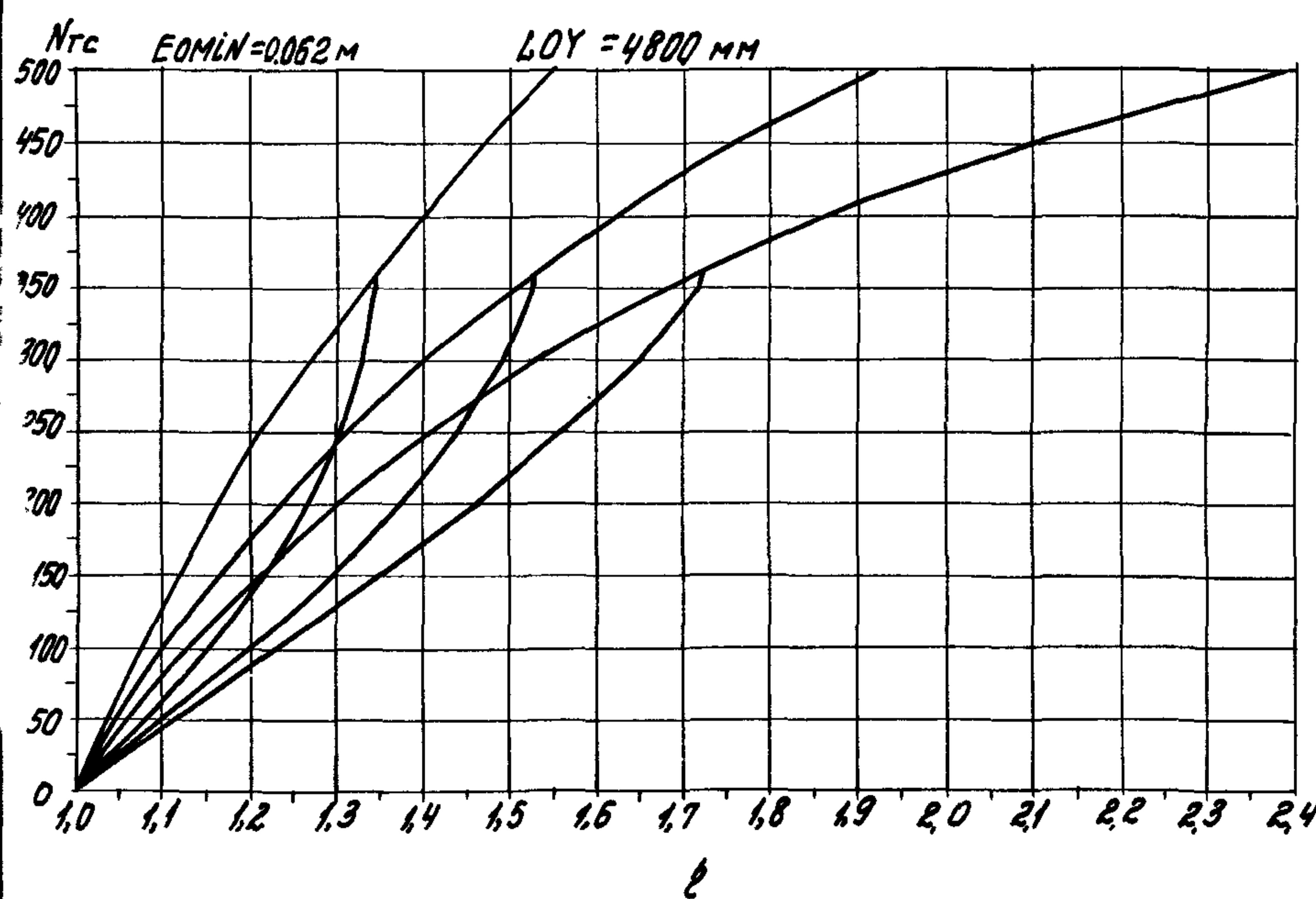
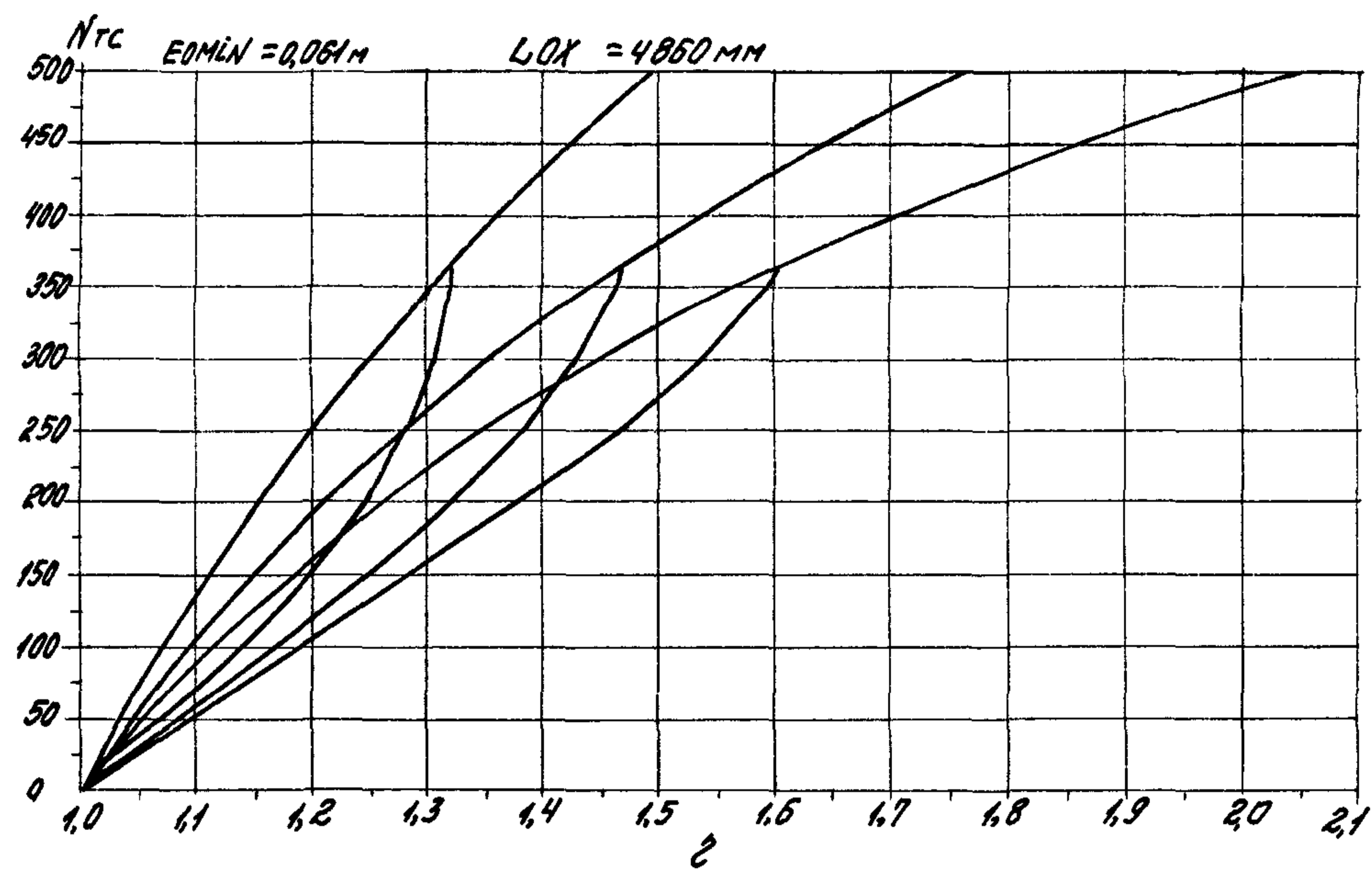
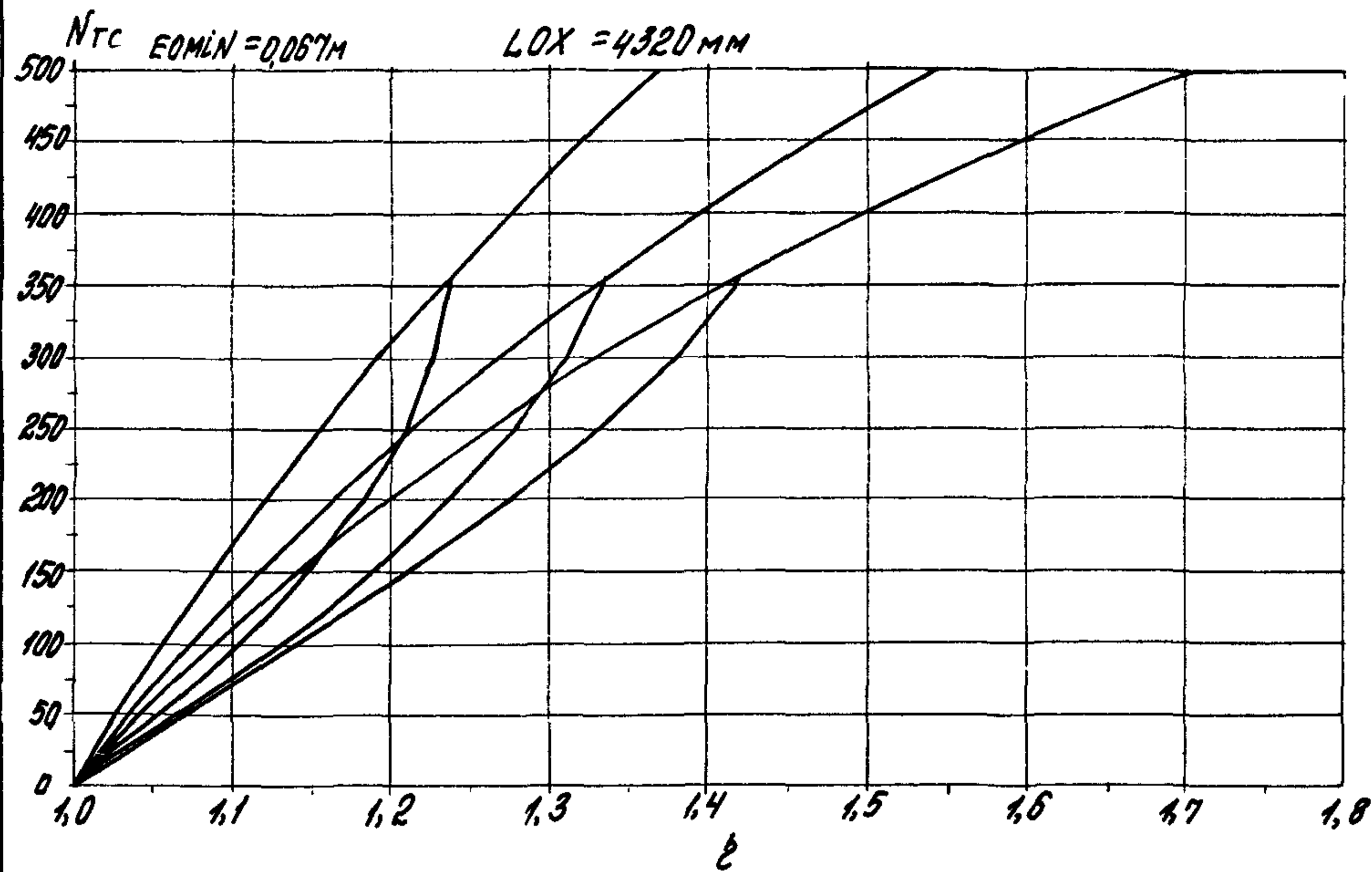

УНУ. АМТОВ И
1007116 И ДАМА
ВООМ. УНУ. №

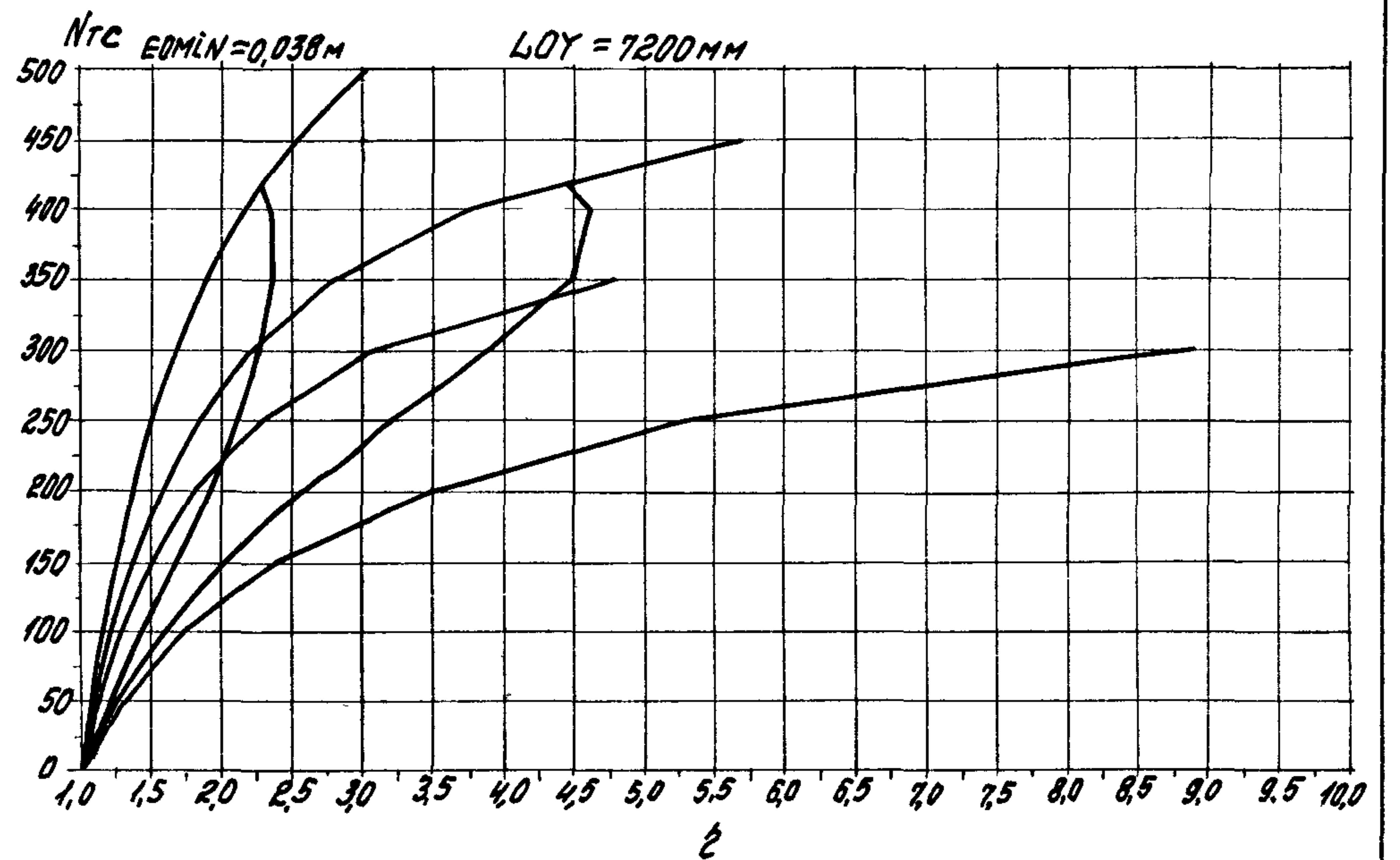
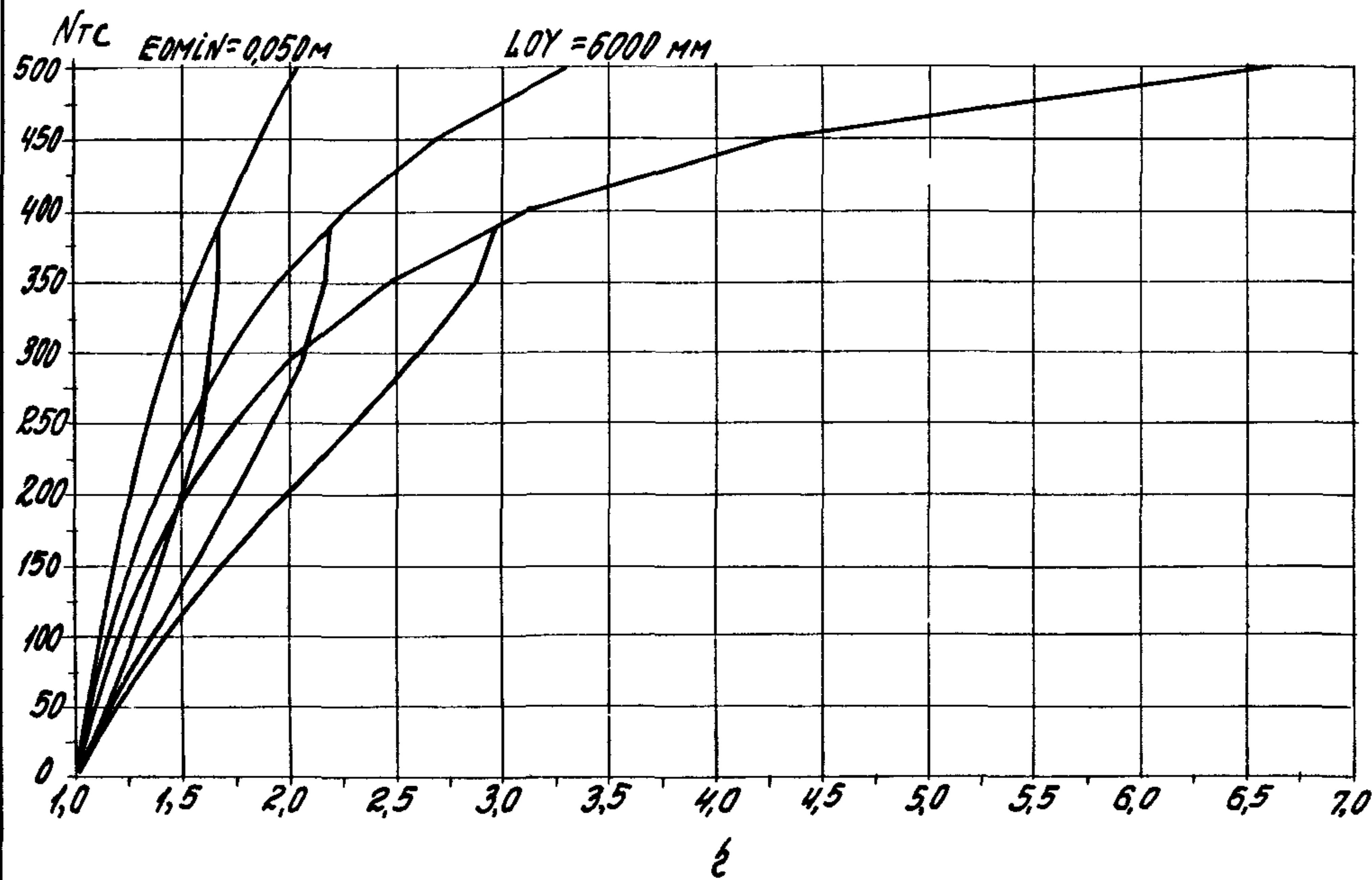
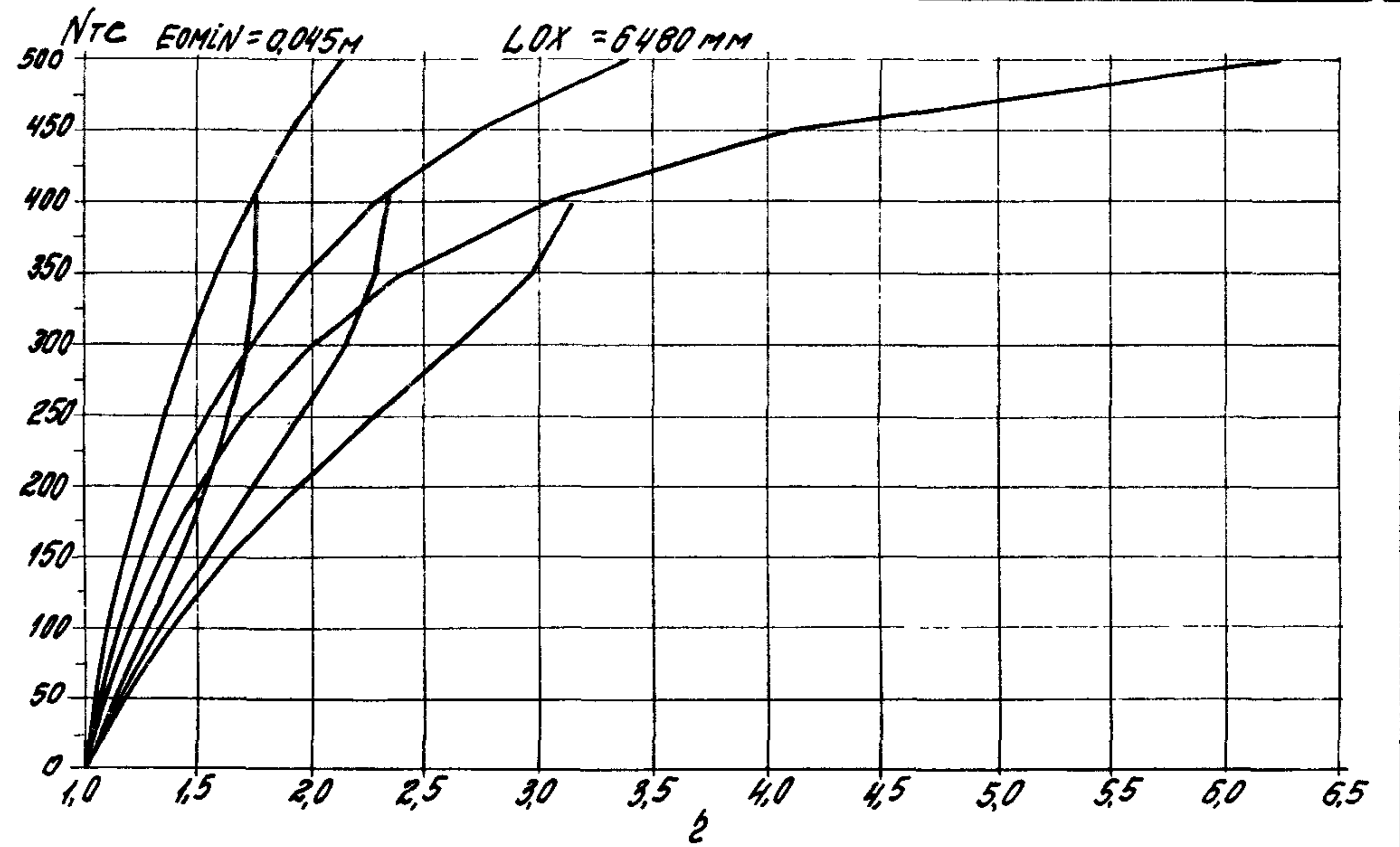
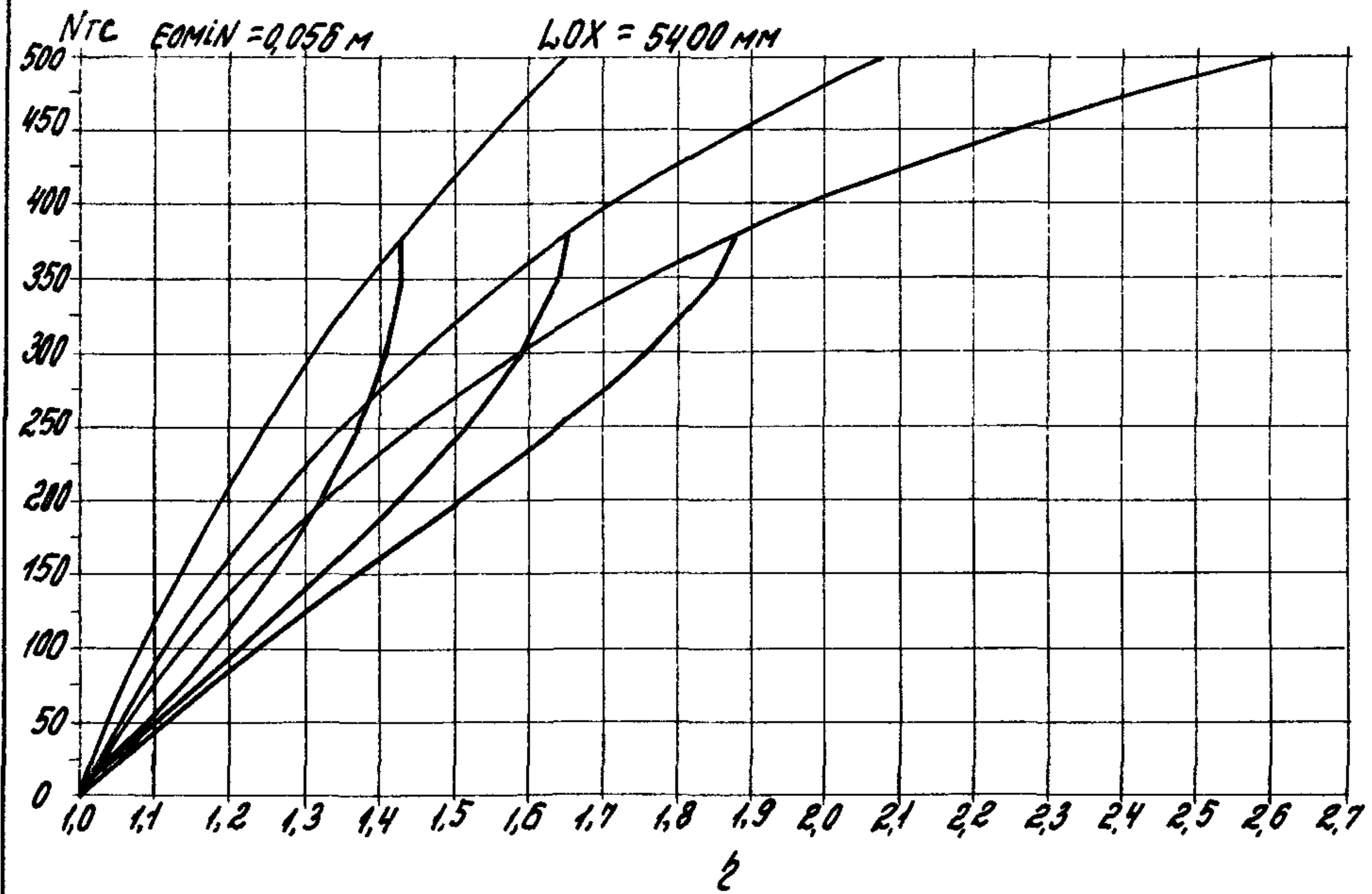

Кад. № 100001. Подпись и дата. Подпись и дата.